

Fixed-Point Designer™

Reference



MATLAB®

R2021a



How to Contact MathWorks



Latest news: www.mathworks.com
Sales and services: www.mathworks.com/sales_and_services
User community: www.mathworks.com/matlabcentral
Technical support: www.mathworks.com/support/contact_us



Phone: 508-647-7000



The MathWorks, Inc.
1 Apple Hill Drive
Natick, MA 01760-2098

Fixed-Point Designer™ Reference

© COPYRIGHT 2013–2021 by The MathWorks, Inc.

The software described in this document is furnished under a license agreement. The software may be used or copied only under the terms of the license agreement. No part of this manual may be photocopied or reproduced in any form without prior written consent from The MathWorks, Inc.

FEDERAL ACQUISITION: This provision applies to all acquisitions of the Program and Documentation by, for, or through the federal government of the United States. By accepting delivery of the Program or Documentation, the government hereby agrees that this software or documentation qualifies as commercial computer software or commercial computer software documentation as such terms are used or defined in FAR 12.212, DFARS Part 227.72, and DFARS 252.227-7014. Accordingly, the terms and conditions of this Agreement and only those rights specified in this Agreement, shall pertain to and govern the use, modification, reproduction, release, performance, display, and disclosure of the Program and Documentation by the federal government (or other entity acquiring for or through the federal government) and shall supersede any conflicting contractual terms or conditions. If this License fails to meet the government's needs or is inconsistent in any respect with federal procurement law, the government agrees to return the Program and Documentation, unused, to The MathWorks, Inc.

Trademarks

MATLAB and Simulink are registered trademarks of The MathWorks, Inc. See www.mathworks.com/trademarks for a list of additional trademarks. Other product or brand names may be trademarks or registered trademarks of their respective holders.

Patents

MathWorks products are protected by one or more U.S. patents. Please see www.mathworks.com/patents for more information.

Revision History

March 2013	Online only	New for Version 4.0 (R2013a)
September 2013	Online only	Revised for Version 4.1 (R2013b)
March 2014	Online only	Revised for Version 4.2 (R2014a)
October 2014	Online Only	Revised for Version 4.3 (R2014b)
March 2015	Online Only	Revised for Version 5.0 (R2015a)
September 2015	Online Only	Revised for Version 5.1 (R2015b)
October 2015	Online only	Rereleased for Version 5.0.1 (Release 2015aSP1)
March 2016	Online Only	Revised for Version 5.2 (R2016a)
September 2016	Online only	Revised for Version 5.3 (R2016b)
March 2017	Online only	Revised for Version 5.4 (R2017a)
September 2017	Online only	Revised for Version 6.0 (R2017b)
March 2018	Online only	Revised for Version 6.1 (R2018a)
September 2018	Online only	Revised for Version 6.2 (R2018b)
March 2019	Online only	Revised for Version 6.3 (R2019a)
September 2019	Online only	Revised for Version 6.4 (R2019b)
March 2020	Online only	Revised for Version 7.0 (R2020a)
September 2020	Online only	Revised for Version 7.1 (R2020b)
March 2021	Online only	Revised for Version 7.2 (R2021a)

1 Apps

2 Blocks

3 Properties

fi Object Properties	3-2
bin	3-2
data	3-2
dec	3-2
double	3-2
fimath	3-2
hex	3-2
int	3-3
NumericType	3-3
oct	3-3
Value	3-3
quantizer Object Properties	3-4
DataMode	3-4
Format	3-4
OverflowMode	3-5
RoundingMode	3-5

4	Functions
5	Classes
6	Methods
A	Selected Bibliography

Apps

Fixed-Point Converter

Convert MATLAB code to fixed point

Description

The Fixed-Point Converter app converts floating-point MATLAB® code to fixed-point MATLAB code.

Using the app, you can:

- Propose data types based on simulation range data, static range data, or both.
- Propose fraction lengths based on default word lengths or propose word lengths based on default fraction lengths.
- Optimize whole numbers.
- Specify safety margins for simulation min/max data.
- View a histogram of bits used by each variable.
- Specify replacement functions or generate approximate functions for functions in the original MATLAB algorithm that do not support fixed point.
- Test the numerical behavior of the fixed-point code. You can then compare its behavior against the floating-point version of your algorithm using either the Simulation Data Inspector or your own custom plotting functions.

If your end goal is to generate fixed-point C code, use the MATLAB Coder™ app instead. See “Convert MATLAB Code to Fixed-Point C Code” (MATLAB Coder).

If your end goal is to generate HDL code, use the HDL Coder™ workflow advisor instead. See “Floating-Point to Fixed-Point Conversion” (HDL Coder).

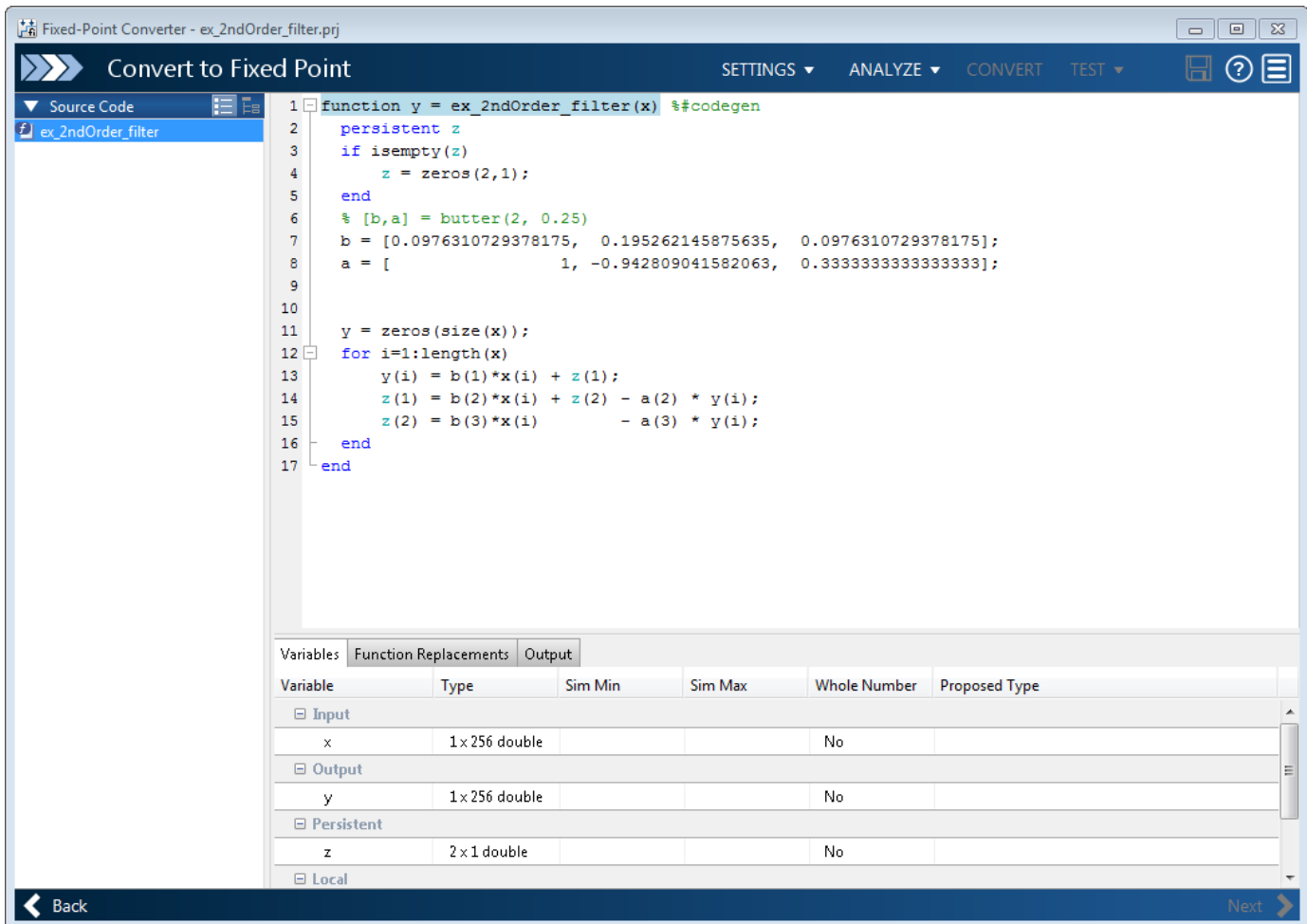

Open the Fixed-Point Converter App

- MATLAB Toolstrip: On the **Apps** tab, under **Code Generation**, click the app icon.
- MATLAB command prompt: Enter `fixedPointConverter`.
- To open an existing Fixed-Point Converter app project, either double-click the `.prj` file or open the app and browse to the project file.

Creating a project or opening an existing project causes any other Fixed-Point Converter or MATLAB Coder projects to close.

- A MATLAB Coder project opens in the MATLAB Coder app. To convert the project to a Fixed-Point Converter app project, in the MATLAB Coder app:

- 1 Click  and select **Reopen project as**.
- 2 Select Fixed-Point Converter.

Examples

- “Propose Data Types Based on Simulation Ranges”
- “Propose Data Types Based on Simulation Ranges”
- “Propose Data Types Based on Derived Ranges”

Programmatic Use

`fixedPointConverter` opens the Fixed-Point Converter app.

`fixedPointConverter -tocode projectname` converts the existing project named `projectname.prj` to the equivalent script of MATLAB commands. It writes the script to the Command Window.

`fixedPointConverter -tocode projectname -script scriptname` converts the existing project named `projectname.prj` to the equivalent script of MATLAB commands. The script is named `scriptname.m`.

- If `scriptname` already exists, `fixedPointConverter` overwrites it.
- The script contains the MATLAB commands to:
 - Create a floating-point to fixed-point conversion configuration object that has the same fixed-point conversion settings as the project.
 - Run the `fiaccl` command to convert the floating-point MATLAB function to a fixed-point MATLAB function.

Before converting the project to a script, you must complete the **Test** step of the fixed-point conversion process.

See Also

Functions

`fiaccl`

Topics

“Propose Data Types Based on Simulation Ranges”

“Propose Data Types Based on Simulation Ranges”

“Propose Data Types Based on Derived Ranges”

“Fixed-Point Conversion Workflows”

“Automated Fixed-Point Conversion”

“Generated Fixed-Point Code”

“Automated Fixed-Point Conversion in MATLAB”

Introduced in R2014b

Fixed-Point Tool

Convert floating-point model to fixed-point

Description

In conjunction with Fixed-Point Designer software, the Fixed-Point Tool provides convenient access to:

- An interactive automatic data typing feature that proposes fixed-point data types for appropriately configured objects in your model, and then allows you to selectively accept and apply the data type proposals
- Model and subsystem parameters that control the signal logging, fixed-point instrumentation mode, and data type override
- Plotting capabilities that enable you to plot data that resides in the MATLAB workspace

Most of the functionality in the Fixed-Point Tool is for use with the Fixed-Point Designer software. However, even if you do not have Fixed-Point Designer software, you can configure data type override settings to simulate a model that specifies fixed-point data types. In this mode, the Simulink® software temporarily overrides fixed-point data types with floating-point data types when simulating the model.

Open the Fixed-Point Tool

- In the Simulink **Apps** tab, select **Fixed-Point Tool**.
- From a subsystem context (right-click) menu, select **Fixed-Point Tool**.
- From the MATLAB command prompt, enter `fxptdlg(system_name)` where `system_name` is the name of the model or system you want to convert, specified as a string.

Examples

- “Convert Floating-Point Model to Fixed Point”
- “Convert a Model to Fixed Point Using the Command Line”

See Also

“Autoscaling Using the Fixed-Point Tool” | “The Command-Line Interface for the Fixed-Point Tool” | `fxptdlg`

Topics

“Convert Floating-Point Model to Fixed Point”
“Convert a Model to Fixed Point Using the Command Line”

Introduced before R2006a

Lookup Table Optimizer

Optimize an existing lookup table or approximate a function with a lookup table

Description

Use the Lookup Table Optimizer to obtain an optimized (memory-efficient) lookup table that approximates an existing Simulink block, including Subsystem blocks and math function blocks, or a function handle. The optimizer supports any combination of floating-point and fixed-point data types. The original input and output data types can be kept or changed as desired. To minimize memory used, the optimizer selects the data types of breakpoints and table data, as well as the number and spacing of breakpoints.

The screenshot shows the 'Objective' tab of the Lookup Table Optimizer app. At the top, there are four tabs: 'Objective', 'Setup', 'Create', and 'Results'. The 'Objective' tab is selected and contains a 'Welcome to the Lookup Table (LUT) Optimizer' message with a small icon of a graph. Below the message, there is a section titled 'Select the source for memory efficient LUT' with two radio button options: 'Simulink block' (which is selected) and 'MATLAB Function Handle'. Each option has a small description below it. To the right of the main content area is an 'About' panel with text explaining the app's purpose and a 'Next' button at the bottom right.

Open the Lookup Table Optimizer App

- In a Simulink model, on the **Apps** tab, click the arrow on the far right of the **Apps** section. In the **Code Generation** gallery, click **Lookup Table Optimizer**.
- In a Simulink model with a Lookup Table block, select the Lookup Table block, in the **Lookup Table** tab, select **Lookup Table Optimizer**.

See Also

Classes

FunctionApproximation.LUTMemoryUsageCalculator |
FunctionApproximation.LUTSolution | FunctionApproximation.Options |
FunctionApproximation.Problem

Functions

approximate | compare | displayallsolutions | displayfeasiblesolutions |
solutionfromID | solve | totalmemoryusage

Topics

“Optimize Lookup Tables for Memory-Efficiency Programmatically”
“Optimize Lookup Tables for Memory-Efficiency”

Introduced in R2018a

Single Precision Converter

Convert double-precision system to single precision

Description

The Single Precision Converter automatically converts a double-precision system to single precision.

During the conversion process, the converter replaces all user-specified double-precision data types, as well as output data types that compile to double precision, with single-precision data types. The converter does not change built-in integer, Boolean, or fixed-point data types.

Open the Single Precision Converter

- From the Simulink **Apps** tab, select **Single Precision Converter**.

Examples

- “Convert a System to Single Precision”

Programmatic Use

`report = DataTypeWorkflow.Single.convertToSingle(systemToConvert)` converts the system specified by `systemToConvert` to single-precision and returns a report. The `systemToConvert` must be open before you begin the conversion.

See Also

Functions

`convertToSingle`

Topics

“Convert a System to Single Precision”

“Getting Started with Single Precision Converter”

Introduced in R2016b

Simulation Data Inspector

Inspect and compare data and simulation results to validate and iterate model designs

Description

The Simulation Data Inspector visualizes and compares multiple kinds of data.

Using the Simulation Data Inspector, you can inspect and compare time series data at multiple stages of your workflow. This example workflow shows how the Simulation Data Inspector supports all stages of the design cycle:

1 “View Data in the Simulation Data Inspector”.

Run a simulation in a model configured to log data to the Simulation Data Inspector, or import data from the workspace or a MAT-file. You can view and verify model input data or inspect logged simulation data while iteratively modifying your model diagram, parameter values, or model configuration.

2 “Inspect Simulation Data”.

Plot signals on multiple subplots, zoom in and out on specified plot axes, and use data cursors to understand and evaluate the data. “Create Plots Using the Simulation Data Inspector” to tell your story.

3 “Compare Simulation Data”

Compare individual signals or simulation runs and analyze your comparison results with relative, absolute, and time tolerances. The compare tools in the Simulation Data Inspector facilitate iterative design and allow you to highlight signals that do not meet your tolerance requirements. For more information about the comparison operation, see “How the Simulation Data Inspector Compares Data”.

4 “Save and Share Simulation Data Inspector Data and Views”.

Share your findings with others by saving Simulation Data Inspector data and views.

You can also harness the capabilities of the Simulation Data Inspector from the command line. For more information, see “Inspect and Compare Data Programmatically”.

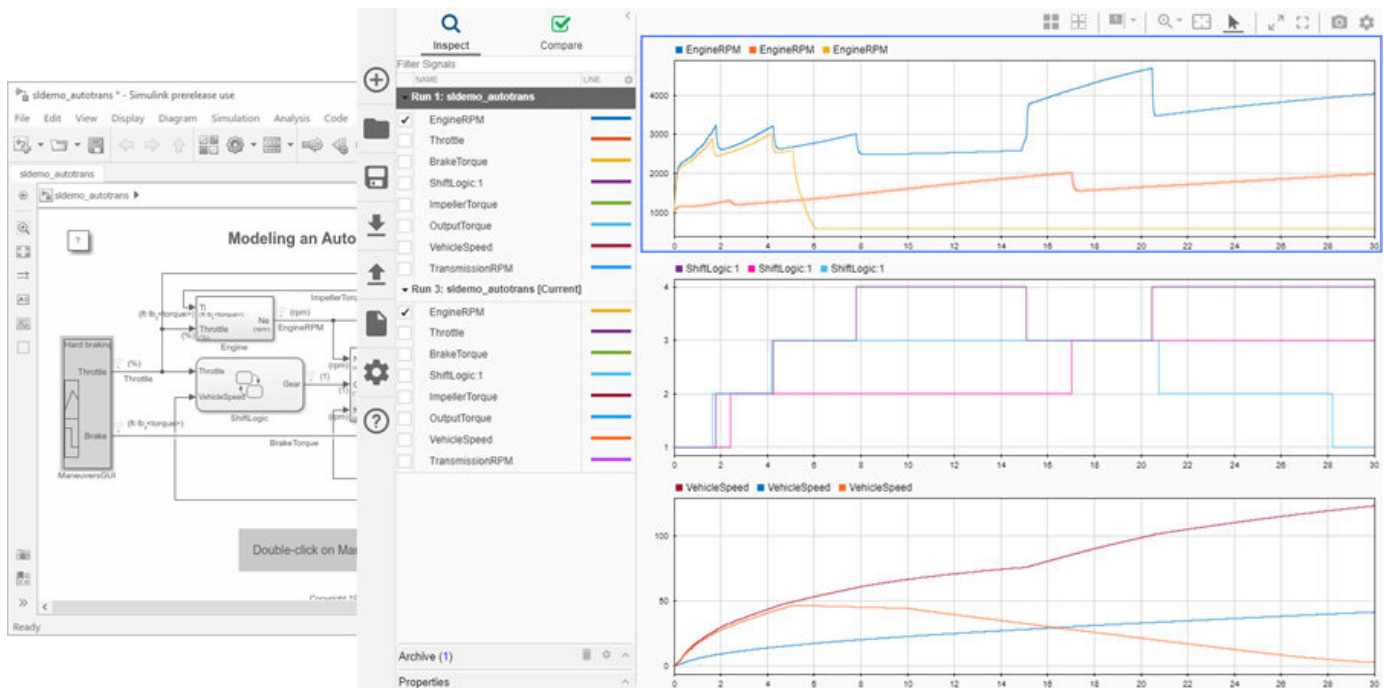

Open the Simulation Data Inspector

- Simulink Toolstrip: On the **Simulation** tab, under **Review Results**, click **Data Inspector**.
- Click the streaming badge on a signal to open the Simulation Data Inspector and plot the signal.
- MATLAB command prompt: Enter `Simulink.sdi.view`.

Examples

Apply a Tolerance to a Signal in Multiple Runs

You can use the Simulation Data Inspector programmatic interface to modify a parameter for the same signal in multiple runs. This example adds an absolute tolerance of 0.1 to a signal in all four runs of data.

First, clear the workspace and load the Simulation Data Inspector session with the data. The session includes logged data from four simulations of a Simulink® model of a longitudinal controller for an aircraft.

```
Simulink.sdi.clear
Simulink.sdi.load('AircraftExample.mldatx');
```

Use the `Simulink.sdi.getRunCount` function to get the number of runs in the Simulation Data Inspector. You can use this number as the index for a for loop that operates on each run.

```
count = Simulink.sdi.getRunCount;
```

Then, use a for loop to assign the absolute tolerance of 0.1 to the first signal in each run.

```
for a = 1:count
    runID = Simulink.sdi.getRunIDByIndex(a);
    aircraftRun = Simulink.sdi.getRun(runID);
    sig = getSignalByIndex(aircraftRun,1);
    sig.AbsTol = 0.1;
end
```

- “View Data in the Simulation Data Inspector”
- “Inspect Simulation Data”
- “Compare Simulation Data”
- “Iterate Model Design Using the Simulation Data Inspector”

Programmatic Use

`Simulink.sdi.view` opens the Simulation Data Inspector from the MATLAB command line.

See Also

Functions

`Simulink.sdi.clear` | `Simulink.sdi.clearPreferences` | `Simulink.sdi.snapshot`

Topics

“View Data in the Simulation Data Inspector”

“Inspect Simulation Data”

“Compare Simulation Data”

“Iterate Model Design Using the Simulation Data Inspector”

Introduced in R2010b

Blocks

Complex Burst Matrix Solve Using Q-less QR Decomposition

Compute the value of X in the equation $A'AX = B$ for complex-valued matrices using Q-less QR decomposition

Library: Fixed-Point Designer HDL Support / Matrices and Linear Algebra / Linear System Solvers

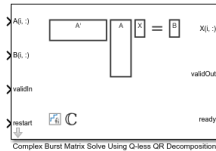

Description

The Complex Burst Matrix Solve Using Q-less QR Decomposition block solves the system of linear equations, $A'AX = B$, using Q-less QR decomposition, where A and B are complex-valued matrices.

Ports

Input

A(i, :) — Rows of matrix A
vector

Rows of matrix A , specified as a vector. A is an m -by- n matrix where $m \geq 2$ and $m \geq n$. If B is single or double, A must be the same data type as B . If A is a fixed-point data type, A must be signed, use binary-point scaling, and have the same word length as B . Slope-bias representation is not supported for fixed-point data types.

Data Types: `single` | `double` | `fixed point`

B(i, :) — Rows of matrix B
vector

Rows of matrix B , specified as a vector. B is an m -by- p matrix where $m \geq 2$. If A is single or double, B must be the same data type as A . If B is a fixed-point data type, B must be signed, use binary-point scaling, and have the same word length as A . Slope-bias representation is not supported for fixed-point data types.

Data Types: `single` | `double` | `fixed point`

validIn — Whether inputs are valid
Boolean scalar

Whether inputs are valid, specified as a Boolean scalar. This control signal indicates when the data from the **A(i,:)** and **B(i,:)** input ports are valid. When this value is 1 (true) and the **ready** value is 1 (true), the block captures the values at the **A(i,:)** and **B(i,:)** input ports. When this value is 0 (false), the block ignores the input samples.

After sending a `true` **validIn** signal, there may be some delay before **ready** is set to `false`. To ensure all data is processed, you must wait until **ready** is set to `false` before sending another `true` **validIn** signal.

Data Types: Boolean

restart — Whether to clear internal states

Boolean scalar

Whether to clear internal states, specified as a Boolean scalar. When this value is 1 (`true`), the block stops the current calculation and clears all internal states. When this value is 0 (`false`) and the **validIn** value is 1 (`true`), the block begins a new subframe.

Data Types: Boolean

Output

X(i, :) — Rows of matrix X

scalar | vector

Rows of the matrix X, returned as a scalar or vector.

Data Types: single | double | fixed point

validOut — Whether output data is valid

Boolean scalar

Whether the output data is valid, returned as a Boolean scalar. This control signal indicates when the data at the output port **X(i,:)** is valid. When this value is 1 (`true`), the block has successfully computed a row of X. When this value is 0 (`false`), the output data is not valid.

Data Types: Boolean

ready — Whether block is ready

Boolean scalar

Whether the block is ready, returned as a Boolean scalar. This control signal indicates when the block is ready for new input data. When this value is 1 (`true`) and the **validIn** value is 1 (`true`), the block accepts input data in the next time step. When this value is 0 (`false`), the block ignores input data in the next time step.

After sending a `true` **validIn** signal, there may be some delay before **ready** is set to `false`. To ensure all data is processed, you must wait until **ready** is set to `false` before sending another `true` **validIn** signal.

Data Types: Boolean

Parameters

Number of rows in matrix A — Number of rows in matrix A

4 (default) | positive integer-valued scalar

Number of rows in matrix A, specified as a positive integer-valued scalar.

Programmatic Use

Block Parameter: m

Type: character vector
Values: positive integer-valued scalar
Default: 4

Number of columns in matrix A and rows in matrix B — Number of columns in matrix A and rows in matrix B

4 (default) | positive integer-valued scalar

Number of columns in matrix *A* and rows in matrix *B*, specified as a positive integer-valued scalar.

Programmatic Use

Block Parameter: n
Type: character vector
Values: positive integer-valued scalar
Default: 4

Number of columns in matrix B — Number of columns in matrix B

1 (default) | positive integer-valued scalar

Number of columns in matrix *B*, specified as a positive integer-valued scalar.

Programmatic Use

Block Parameter: p
Type: character vector
Values: positive integer-valued scalar
Default: 1

Output datatype — Data type of output matrix X

fixdt(1,18,14) (default) | double | single | fixdt(1,16,0) | <data type expression>

Data type of the output matrix *X*, specified as `fixdt(1,18,14)`, `double`, `single`, `fixdt(1,16,0)`, or as a user-specified data type expression. The type can be specified directly, or expressed as a data type object such as `Simulink.NumericType`.

Programmatic Use

Block Parameter: OutputType
Type: character vector
Values: 'fixdt(1,18,14)' | 'double' | 'single' | 'fixdt(1,16,0)' | '<data type expression>'
Default: 'fixdt(1,18,14)'

Tips

Use `fixed.getQlessQRMatrixSolveModel(A,B)` to generate a template model containing a Complex Burst Matrix Solve Using Q-less QR Decomposition block for complex-valued input matrices *A* and *B*.

Extended Capabilities

C/C++ Code Generation

Generate C and C++ code using Simulink® Coder™.

Slope-bias representation is not supported for fixed-point data types.

HDL Code Generation

Generate Verilog and VHDL code for FPGA and ASIC designs using HDL Coder™.

HDL Coder provides additional configuration options that affect HDL implementation and synthesized logic.

HDL Architecture

This block has a single, default HDL architecture.

HDL Block Properties

General	
ConstrainedOutputPipeline	Number of registers to place at the outputs by moving existing delays within your design. Distributed pipelining does not redistribute these registers. The default is 0. For more details, see “ConstrainedOutputPipeline” (HDL Coder).
InputPipeline	Number of input pipeline stages to insert in the generated code. Distributed pipelining and constrained output pipelining can move these registers. The default is 0. For more details, see “InputPipeline” (HDL Coder).
OutputPipeline	Number of output pipeline stages to insert in the generated code. Distributed pipelining and constrained output pipelining can move these registers. The default is 0. For more details, see “OutputPipeline” (HDL Coder).

Restrictions

Supports fixed-point data types only.

Fixed-Point Conversion

Design and simulate fixed-point systems using Fixed-Point Designer™.

A and B must be signed, use binary-point scaling, and have the same word length. Slope-bias representation is not supported for fixed-point data types.

See Also**Blocks**

Complex Partial-Systolic Matrix Solve Using Q-less QR Decomposition | Complex Burst Matrix Solve Using QR Decomposition | Real Burst Matrix Solve Using Q-less QR Decomposition

Functions

`fixed.qlessQRMatrixSolve`

Introduced in R2020a

Complex Burst Matrix Solve Using QR Decomposition

Compute the value of x in the equation $Ax = B$ for complex-valued matrices using QR decomposition

Library: Fixed-Point Designer HDL Support / Matrices and Linear Algebra / Linear System Solvers

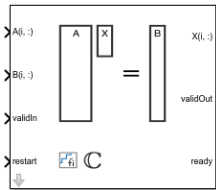

Description

The Complex Burst Matrix Solve Using QR Decomposition block solves the system of linear equations $Ax = B$ using QR decomposition, where A and B are complex-valued matrices. To compute $x = A^{-1}$, set B to be the identity matrix.

Ports

Input

$A(i, :)$ — Rows of matrix A

vector

Rows of matrix A , specified as a vector. A is an m -by- n matrix where $m \geq 2$ and $m \geq n$. If B is single or double, A must be the same data type as B . If A is a fixed point data type, A must be signed, use binary-point scaling, and have the same word length as B . Slope-bias representation is not supported for fixed-point data types.

Data Types: `single` | `double` | `fixed point`

$B(i, :)$ — Rows of matrix B

vector

Rows of matrix B , specified as a vector. B is an m -by- p matrix where $m \geq 2$. If A is single or double, B must be the same data type as A . If B is a fixed-point data type, B must be signed, use binary-point scaling, and have the same word length as A . Slope-bias representation is not supported for fixed-point data types.

Data Types: `single` | `double` | `fixed point`

`validIn` — Whether inputs are valid

Boolean scalar

Whether inputs are valid, specified as a Boolean scalar. This control signal indicates when the data from the $A(i, :)$ and $B(i, :)$ input ports are valid. When this value is 1 (`true`) and the value at `ready` is 1 (`true`), the block captures the values at the $A(i, :)$ and $B(i, :)$ input ports. When this value is 0 (`false`), the block ignores the input samples.

After sending a `true` **validIn** signal, there may be some delay before **ready** is set to `false`. To ensure all data is processed, you must wait until **ready** is set to `false` before sending another `true` **validIn** signal.

Data Types: Boolean

restart — Whether to clear internal states

Boolean scalar

Whether to clear internal states, specified as a Boolean scalar. When this value is 1 (`true`), the block stops the current calculation and clears all internal states. When this value is 0 (`false`) and the **validIn** value is 1 (`true`), the block begins a new subframe.

Data Types: Boolean

Output

X(i, :) — Rows of matrix *X*

scalar | vector

Rows of the matrix *X*, returned as a scalar or vector.

Data Types: single | double | fixed point

validOut — Whether output data is valid

Boolean scalar

Whether the output data is valid, returned as a Boolean scalar. This control signal indicates when the data at the output port **X(i,:)** is valid. When this value is 1 (`true`), the block has successfully computed a row of matrix *X*. When this value is 0 (`false`), the output data is not valid.

Data Types: Boolean

ready — Whether block is ready

Boolean scalar

Whether the block is ready, returned as a Boolean scalar. This control signal indicates when the block is ready for new input data. When this value is 1 (`true`) and **validIn** value is 1 (`true`), the block accepts input data in the next time step. When this value is 0 (`false`), the block ignores input data in the next time step.

After sending a `true` **validIn** signal, there may be some delay before **ready** is set to `false`. To ensure all data is processed, you must wait until **ready** is set to `false` before sending another `true` **validIn** signal.

Data Types: Boolean

Parameters

Number of rows in matrices A and B — Number of rows in matrices *A* and *B*

4 (default) | positive integer-valued scalar

Number of rows in input matrices *A* and *B*, specified as a positive integer-valued scalar.

Programmatic Use

Block Parameter: *m*

Type: character vector
Values: positive integer-valued scalar
Default: 4

Number of columns in matrix A — Number of columns in matrix A

4 (default) | positive integer-valued scalar

Number of columns in input matrix *A*, specified as a positive integer-valued scalar.

Programmatic Use

Block Parameter: n
Type: character vector
Values: positive integer-valued scalar
Default: 4

Number of columns in matrix B — Number of columns in matrix B

1 (default) | positive integer-valued scalar

Number of columns in input matrix *B*, specified as a positive integer-valued scalar.

Programmatic Use

Block Parameter: p
Type: character vector
Values: positive integer-valued scalar
Default: 1

Output datatype — Data type of the output matrix X

fixdt(1,18,14) (default) | double | single | fixdt(1,16,0) | <data type expression>

Data type of the output matrix *X*, specified as `fixdt(1,18,14)`, `double`, `single`, `fixdt(1,16,0)`, or as a user-specified data type expression. The type can be specified directly, or expressed as a data type object such as `Simulink.NumericType`.

Programmatic Use

Block Parameter: OutputType
Type: character vector
Values: 'fixdt(1,18,14)' | 'double' | 'single' | 'fixdt(1,16,0)' | '<data type expression>'
Default: 'fixdt(1,18,14)'

Tips

Use `fixed.getMatrixSolveModel(A,B)` to generate a template model containing a Complex Burst Matrix Solve Using QR Decomposition block for complex-valued input matrices *A* and *B*.

Extended Capabilities

C/C++ Code Generation

Generate C and C++ code using Simulink® Coder™.

Slope-bias representation is not supported for fixed-point data types.

HDL Code Generation

Generate Verilog and VHDL code for FPGA and ASIC designs using HDL Coder™.

HDL Coder provides additional configuration options that affect HDL implementation and synthesized logic.

HDL Architecture

This block has a single, default HDL architecture.

HDL Block Properties

General	
ConstrainedOutputPipeline	Number of registers to place at the outputs by moving existing delays within your design. Distributed pipelining does not redistribute these registers. The default is 0. For more details, see “ConstrainedOutputPipeline” (HDL Coder).
InputPipeline	Number of input pipeline stages to insert in the generated code. Distributed pipelining and constrained output pipelining can move these registers. The default is 0. For more details, see “InputPipeline” (HDL Coder).
OutputPipeline	Number of output pipeline stages to insert in the generated code. Distributed pipelining and constrained output pipelining can move these registers. The default is 0. For more details, see “OutputPipeline” (HDL Coder).

Restrictions

Supports fixed-point data types only.

Fixed-Point Conversion

Design and simulate fixed-point systems using Fixed-Point Designer™.

A and B must be signed, use binary-point scaling, and have the same word length. Slope-bias representation is not supported for fixed-point data types.

See Also

Blocks

Complex Partial-Systolic Matrix Solve Using QR Decomposition | Real Burst Matrix Solve Using Q-less QR Decomposition | Real Burst Matrix Solve Using QR Decomposition

Functions

`fixed.qrMatrixSolve`

Introduced in R2019b

Complex Burst Q-less QR Decomposition

Q-less QR decomposition for complex-valued matrices

Library: Fixed-Point Designer HDL Support / Matrices and Linear Algebra / Matrix Factorizations

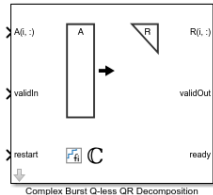

Description

The Complex Burst Q-less QR Decomposition block uses QR decomposition to compute the economy size upper-triangular R factor of the QR decomposition $A = QR$, where A is a complex-valued matrix, without computing Q . The solution to $A'Ax = B$ is $x = R \setminus R' \setminus b$.

Ports

Input

A(i, :) — Rows of complex matrix A
vector

Rows of complex matrix A , specified as a vector. A is a m -by- n matrix where $m \geq 2$ and $n \geq 2$. If A is a fixed-point data type, A must be signed and use binary-point scaling. Slope-bias representation is not supported for fixed-point data types.

Data Types: `single` | `double` | `fixed point`

validIn — Whether inputs are valid
Boolean scalar

Whether inputs are valid, specified as a Boolean scalar. This control signal indicates when the data at the **A(i,:)** input port is valid. When this value is 1 (`true`) and the value at **ready** is 1 (`true`), the block captures the values at the **A(i,:)** input port. When this value is 0 (`false`), the block ignores the input samples.

After sending a `true` **validIn** signal, there may be some delay before **ready** is set to `false`. To ensure all data is processed, you must wait until **ready** is set to `false` before sending another `true` **validIn** signal.

Data Types: `Boolean`

restart — Whether to clear internal states
Boolean scalar

Whether to clear internal states, specified as a Boolean scalar. When this value is 1 (`true`), the block stops the current calculation and clears all internal states. When this value is 0 (`false`) and the **validIn** value is 1 (`true`), the block begins a new subframe.

Data Types: Boolean

Output

R(i, :) — Rows of upper-triangular matrix *R*

scalar | vector

Rows of the economy size QR decomposition matrix *R*, returned as a scalar or vector. *R* is an upper-triangular matrix. The output at **R(i,:)** has the same data type as the input at **A(i,:)**.

Data Types: single | double | fixed point

validOut — Whether output data is valid

Boolean scalar

Whether the output data is valid, specified as a Boolean scalar. This control signal indicates when the data at output port **R(i,:)** is valid. When this value is 1 (**true**), the block has successfully computed the matrix *R*. When this value is 0 (**false**), the output data is not valid.

Data Types: Boolean

ready — Whether block is ready

Boolean scalar

Whether the block is ready, returned as a Boolean scalar. This control signal indicates when the block is ready for new input data. When this value is 1 (**true**) and the **validIn** value is 1 (**true**), the block accepts input data in the next time step. When this value is 0 (**false**), the block ignores input data in the next time step.

After sending a **true** **validIn** signal, there may be some delay before **ready** is set to **false**. To ensure all data is processed, you must wait until **ready** is set to **false** before sending another **true** **validIn** signal.

Data Types: Boolean

Parameters

Number of rows in matrix A — Number of rows in matrix *A*

4 (default) | positive integer-valued scalar

Number of rows in input matrix *A*, specified as a positive integer-valued scalar.

Programmatic Use

Block Parameter: m

Type: character vector

Values: positive integer-valued scalar

Default: 4

Number of columns in matrix A — Number of columns in matrix *A*

4 (default) | positive integer-valued scalar

Number of columns in input matrix *A*, specified as a positive integer-valued scalar.

Programmatic Use

Block Parameter: n

Type: character vector

Values: positive integer-valued scalar

Default: 4

Tips

Use `fixed.getQlessQRDecompositionModel(A)` to generate a template model containing a Complex Burst Q-less QR Decomposition block for complex-valued input matrix A.

Extended Capabilities

C/C++ Code Generation

Generate C and C++ code using Simulink® Coder™.

Slope-bias representation is not supported for fixed-point data types.

HDL Code Generation

Generate Verilog and VHDL code for FPGA and ASIC designs using HDL Coder™.

HDL Coder provides additional configuration options that affect HDL implementation and synthesized logic.

HDL Architecture

This block has a single, default HDL architecture.

HDL Block Properties

General	
ConstrainedOutputPipeline	Number of registers to place at the outputs by moving existing delays within your design. Distributed pipelining does not redistribute these registers. The default is 0. For more details, see “ConstrainedOutputPipeline” (HDL Coder).
InputPipeline	Number of input pipeline stages to insert in the generated code. Distributed pipelining and constrained output pipelining can move these registers. The default is 0. For more details, see “InputPipeline” (HDL Coder).
OutputPipeline	Number of output pipeline stages to insert in the generated code. Distributed pipelining and constrained output pipelining can move these registers. The default is 0. For more details, see “OutputPipeline” (HDL Coder).

Restrictions

Supports fixed-point data types only.

Fixed-Point Conversion

Design and simulate fixed-point systems using Fixed-Point Designer™.

A must be signed and use binary-point scaling. Slope-bias representation is not supported for fixed-point data types.

See Also

Blocks

Complex Partial-Systolic Q-less QR Decomposition | Complex Burst QR Decomposition | Real Burst Q-less QR Decomposition

Functions

`fixed.qlessQR`

Introduced in R2020a

Complex Burst QR Decomposition

QR decomposition for complex-valued matrices

Library: Fixed-Point Designer HDL Support / Matrices and Linear Algebra / Matrix Factorizations

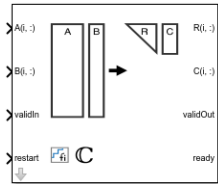

Description

The Complex Burst QR Decomposition block uses QR decomposition to compute R and $C = Q'B$, where $QR = A$, and A and B are complex-valued matrices. The least-squares solution to $Ax = B$ is $x = R \setminus C$. R is an upper triangular matrix and Q is an orthogonal matrix. To compute $C = Q'$, set B to be the identity matrix.

Ports

Input

A(i, :) — Rows of matrix A
vector

Rows of matrix A , specified as a vector. A is an m -by- n matrix where $m \geq 2$ and $n \geq 2$. If B is single or double, A must be the same data type as B . If A is a fixed-point data type, A must be signed, use binary-point scaling, and have the same word length as B . Slope-bias representation is not supported for fixed-point data types.

Data Types: `single` | `double` | `fixed point`

B(i, :) — Rows of matrix B
vector

Rows of matrix B , specified as a vector. B is an m -by- p matrix where $m \geq 2$. If A is single or double, B must be the same data type as A . If B is a fixed-point data type, B must be signed, use binary-point scaling, and have the same word length as A . Slope-bias representation is not supported for fixed-point data types.

Data Types: `single` | `double` | `fixed point`

validIn — Whether inputs are valid
Boolean scalar

Whether inputs are valid, specified as a Boolean scalar. This control signal indicates when the data from the **A(i,:)** and **B(i,:)** input ports are valid. When this value is 1 (`true`) and the value at **ready** is 1 (`true`), the block captures the values on the **A(i,:)** and **B(i,:)** input ports. When this value is 0 (`false`), the block ignores the input samples.

After sending a `true validIn` signal, there may be some delay before `ready` is set to `false`. To ensure all data is processed, you must wait until `ready` is set to `false` before sending another `true validIn` signal.

Data Types: Boolean

restart — Whether to clear internal states

Boolean scalar

Whether to clear internal states, specified as a Boolean scalar. When this value is 1 (`true`), the block stops the current calculation and clears all internal states. When this value is 0 (`false`), and the `validIn` value is 1 (`true`), the block begins a new subframe.

Data Types: Boolean

Output

$R(i, :)$ — Rows of matrix R

scalar | vector

Rows of the economy size QR decomposition matrix R , returned as a scalar or vector. R is an upper triangular matrix. R has the same data type as A .

Data Types: single | double | fixed point

$C(i, :)$ — Rows of matrix $C=Q'B$

scalar | vector

Rows of the economy size QR decomposition matrix $C=Q'B$, returned as a scalar or vector. C has the same number of rows as R . C has the same data type as B .

Data Types: single | double | fixed point

validOut — Whether output data is valid

Boolean scalar

Whether the output data is valid, returned as a Boolean scalar. This control signal indicates when the data at output ports $R(i,:)$ and $C(i,:)$ is valid. When this value is 1 (`true`), the block has successfully computed the R and C matrices. When this value is 0 (`false`), the output data is not valid.

Data Types: Boolean

ready — Whether block is ready

Boolean scalar

Whether the block is ready, returned as a Boolean scalar. This control signal indicates when the block is ready for new input data. When this value is 1 (`true`), and the `validIn` value is 1 (`true`), the block accepts input data in the next time step. When this value is 0 (`false`), the block ignores input data in the next time step.

After sending a `true validIn` signal, there may be some delay before `ready` is set to `false`. To ensure all data is processed, you must wait until `ready` is set to `false` before sending another `true validIn` signal.

Data Types: Boolean

Parameters

Number of rows in matrices A and B — Number of rows in matrices A and B

4 (default) | positive integer-valued scalar

The number of rows in matrices *A* and *B*, specified as a positive integer-valued scalar.

Programmatic Use

Block Parameter: m

Type: character vector

Values: positive integer-valued scalar

Default: 4

Number of columns in matrix A — Number of columns in matrix A

4 (default) | positive integer-valued scalar

The number of columns in input matrix *A*, specified as a positive integer-valued scalar.

Programmatic Use

Block Parameter: n

Type: character vector

Values: positive integer-valued scalar

Default: 4

Number of columns in matrix B — Number of columns in matrix B

1 (default) | positive integer-valued scalar

The number of columns in input matrix *B*, specified as a positive integer-valued scalar.

Programmatic Use

Block Parameter: p

Type: character vector

Values: positive integer-valued scalar

Default: 1

Tips

Use `fixed.getQRDecompositionModel(A,B)` to generate a template model containing a Complex Burst QR Decomposition block for complex-valued input matrices *A* and *B*.

Extended Capabilities

C/C++ Code Generation

Generate C and C++ code using Simulink® Coder™.

Slope-bias representation is not supported for fixed-point data types.

HDL Code Generation

Generate Verilog and VHDL code for FPGA and ASIC designs using HDL Coder™.

HDL Coder provides additional configuration options that affect HDL implementation and synthesized logic.

HDL Architecture

This block has a single, default HDL architecture.

HDL Block Properties

General	
ConstrainedOutputPipeline	Number of registers to place at the outputs by moving existing delays within your design. Distributed pipelining does not redistribute these registers. The default is 0. For more details, see “ConstrainedOutputPipeline” (HDL Coder).
InputPipeline	Number of input pipeline stages to insert in the generated code. Distributed pipelining and constrained output pipelining can move these registers. The default is 0. For more details, see “InputPipeline” (HDL Coder).
OutputPipeline	Number of output pipeline stages to insert in the generated code. Distributed pipelining and constrained output pipelining can move these registers. The default is 0. For more details, see “OutputPipeline” (HDL Coder).

Restrictions

Supports fixed-point data types only.

Fixed-Point Conversion

Design and simulate fixed-point systems using Fixed-Point Designer™.

A and B must be signed, use binary-point scaling, and have the same word length. Slope-bias representation is not supported for fixed-point data types.

See Also**Blocks**

Complex Partial-Systolic QR Decomposition | Complex Burst Q-less QR Decomposition | Real Burst QR Decomposition

Functions

fixed.qrAB

Introduced in R2019b

Complex Divide HDL Optimized

Divide one input by another and generate optimized HDL code

Library: Fixed-Point Designer HDL Support / Math Operations

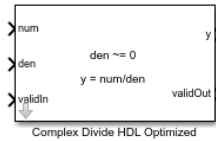

Description

The Complex Divide HDL Optimized block outputs the result of dividing the scalar **num** by the scalar **den**, such that $y = \text{num}/\text{den}$.

Limitations

Data type override is not supported for the Complex Divide HDL Optimized block.

Ports

Input

num — Numerator

scalar

Numerator, specified as a scalar.

Data Types: `single` | `double` | `fixed point`

Complex Number Support: Yes

den — Denominator

scalar

Denominator, specified as a scalar.

Data Types: `single` | `double` | `fixed point`

Complex Number Support: Yes

validIn — Whether input is valid

Boolean scalar

Whether input is valid, specified as a Boolean scalar. This control signal indicates when the data from the **num** and **den** input ports are valid. When this value is 1 (`true`), the block captures the values at the input ports **num** and **den**. When this value is 0 (`false`), the block ignores the input samples.

Data Types: `Boolean`

Output

y — Output computed by dividing inputs

complex scalar

Output computed by dividing **num** by **den**, such that $y = \text{num}/\text{den}$, returned as a complex scalar with data type specified by **Output datatype**.

Data Types: `single` | `double` | `fixed point`

validOut — Whether output data is valid

Boolean scalar

Whether the output data is valid, returned as a Boolean scalar. When the value of this control signal is 1 (`true`), the block has successfully computed the output at port **y**. When this value is 0 (`false`), the output data is not valid.

Data Types: `Boolean`

Parameters

Output datatype — Data type of output

`fixdt(1,18,10)` (default) | `single` | `fixdt(1,16,0)` | `<data type expression>`

Data type of output **y**, specified as `fixdt(1,18,10)`, `single`, `fixdt(1,16,0)`, or as a user-specified data type expression. The type can be specified directly or expressed as a data type object, such as `Simulink.NumericType`.

Programmatic Use

Block Parameter: `OutputType`

Type: character vector

Values: `'fixdt(1,18,10)'` | `'single'` | `'fixdt(1,16,0)'` | `'<data type expression>'`

Default: `'fixdt(1,18,10)'`

Algorithms

For fixed-point inputs **num** and **den**, the Complex Divide HDL Optimized block wraps on overflow for division by zero. The behavior for fixed-point division by zero is summarized in the table below.

Wrap Overflow	Saturate Overflow
0/0 = 0	0/0 = 0
1/0 = 0	1/0 = upper bound
-1/0 = 0	-1/0 = lower bound

For floating-point inputs, the Complex Divide HDL Optimized block follows IEEE® Standard 754.

Extended Capabilities

C/C++ Code Generation

Generate C and C++ code using Simulink® Coder™.

Slope-bias representation is not supported for fixed-point data types.

HDL Code Generation

Generate Verilog and VHDL code for FPGA and ASIC designs using HDL Coder™.

Restrictions

Supports binary-point scaled fixed-point data types only.

Fixed-Point Conversion

Design and simulate fixed-point systems using Fixed-Point Designer™.

Slope-bias representation is not supported for fixed-point data types.

See Also

Normalized Reciprocal HDL Optimized | Real Divide HDL Optimized | Real Reciprocal HDL Optimized

Introduced in R2021a

Complex Partial-Systolic Matrix Solve Using Q-less QR Decomposition

Compute the value of X in $A'AX = B$ for complex-valued matrices using Q-less QR decomposition

Library: Fixed-Point Designer HDL Support / Matrices and Linear Algebra / Linear System Solvers

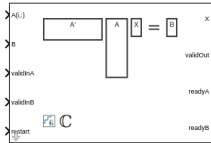

Description

The Complex Partial-Systolic Matrix Solve Using Q-less QR Decomposition block solves the system of linear equations, $A'AX = B$, using Q-less QR decomposition, where A and B are complex-valued matrices.

Ports

Input

A(i, :) — Rows of matrix A
vector

Rows of matrix A , specified as a vector. A is an m -by- n matrix where $m \geq 2$ and $m \geq n$. If B is single or double, A must be the same data type as B . If A is a fixed point data type, A must be signed, use binary-point scaling, and have the same word length as B . Slope-bias representation is not supported for fixed-point data types.

Data Types: `single` | `double` | `fixed point`
Complex Number Support: Yes

B — Matrix B
vector

Matrix B , specified as a vector. B is an m -by- p matrix where $m \geq 2$. If A is single or double, B must be the same data type as A . If B is a fixed-point data type, B must be signed, use binary-point scaling, and have the same word length as A . Slope-bias representation is not supported for fixed-point data types.

Data Types: `single` | `double` | `fixed point`
Complex Number Support: Yes

validInA — Whether input A is valid
Boolean scalar

Whether input A is valid, specified as a Boolean scalar. This control signal indicates when the data from the **A(i,:)** input port is valid. When this value is 1 (`true`) and the value at **readyA** is 1 (`true`), the block captures the values at the **A(i,:)** input port. When this value is 0 (`false`), the block ignores the input samples.

After sending a `true` **validInA** signal, there may be some delay before **readyA** is set to `false`. To ensure all data is processed, you must wait until **readyA** is set to `false` before sending another `true` **validInA** signal.

Data Types: Boolean

validInB — Whether input B is valid

Boolean scalar

Whether input **B** is valid, specified as a Boolean scalar. This control signal indicates when the data from the **B** input port is valid. When this value is 1 (`true`) and the value at **readyB** is 1 (`true`), the block captures the values at the **B** input port. When this value is 0 (`false`), the block ignores the input samples.

After sending a `true` **validInB** signal, there may be some delay before **readyB** is set to `false`. To ensure all data is processed, you must wait until **readyB** is set to `false` before sending another `true` **validInB** signal.

Data Types: Boolean

restart — Whether to clear internal states

Boolean scalar

Whether to clear internal states, specified as a Boolean scalar. When this value is 1 (`true`), the block stops the current calculation and clears all internal states. When this value is 0 (`false`) and the **validIn** value is 1 (`true`), the block begins a new subframe.

Data Types: Boolean

Output

X — Matrix X

matrix | vector

Matrix *X*, returned as a vector or matrix.

Data Types: single | double | fixed point

validOut — Whether output data is valid

Boolean scalar

Whether the output data is valid, returned as a Boolean scalar. This control signal indicates when the data at the output port **X** is valid. When this value is 1 (`true`), the block has successfully computed a row of matrix *X*. When this value is 0 (`false`), the output data is not valid.

Data Types: Boolean

readyA — Whether block is ready for input A

Boolean scalar

Whether the block is ready for input A, returned as a Boolean scalar. This control signal indicates when the block is ready for new input data. When this value is 1 (`true`) and **validInA** value is 1 (`true`), the block accepts input data in the next time step. When this value is 0 (`false`), the block ignores input data in the next time step.

After sending a `true` **validInA** signal, there may be some delay before **readyA** is set to `false`. To ensure all data is processed, you must wait until **readyA** is set to `false` before sending another `true` **validInA** signal.

Data Types: Boolean

readyB — Whether block is ready for input B

Boolean scalar

Whether the block is ready for input B, returned as a Boolean scalar. This control signal indicates when the block is ready for new input data. When this value is 1 (`true`) and **validInB** value is 1 (`true`), the block accepts input data in the next time step. When this value is 0 (`false`), the block ignores input data in the next time step.

After sending a `true` **validInB** signal, there may be some delay before **readyB** is set to `false`. To ensure all data is processed, you must wait until **readyB** is set to `false` before sending another `true` **validInB** signal.

Data Types: Boolean

Parameters

Number of rows in matrix A — Number of rows in matrix A

4 (default) | positive integer-valued scalar

Number of rows in matrix *A*, specified as a positive integer-valued scalar.

Programmatic Use

Block Parameter: *m*

Type: character vector

Values: positive integer-valued scalar

Default: 4

Number of columns in matrix A and rows in matrix B — Number of columns in matrix A and rows in matrix B

4 (default) | positive integer-valued scalar

Number of columns in matrix *A* and rows in matrix *B*, specified as a positive integer-valued scalar.

Programmatic Use

Block Parameter: *n*

Type: character vector

Values: positive integer-valued scalar

Default: 4

Number of columns in matrix B — Number of columns in matrix B

1 (default) | positive integer-valued scalar

Number of columns in matrix *B*, specified as a positive integer-valued scalar.

Programmatic Use

Block Parameter: *p*

Type: character vector

Values: positive integer-valued scalar

Default: 1

Output datatype — Data type of output matrix X

`fixdt(1,18,14)` (default) | `double` | `single` | `fixdt(1,16,0)` | `<data type expression>`

Data type of the output matrix X , specified as `fixdt(1,18,14)`, `double`, `single`, `fixdt(1,16,0)`, or as a user-specified data type expression. The type can be specified directly, or expressed as a data type object such as `Simulink.NumericType`.

Programmatic Use

Block Parameter: `OutputType`

Type: character vector

Values: `'fixdt(1,18,14)'` | `'double'` | `'single'` | `'fixdt(1,16,0)'` | `'<data type expression>'`

Default: `'fixdt(1,18,14)'`

Algorithms**Choosing the Implementation Method**

Partial-systolic implementations prioritize speed of computations over space constraints, while burst implementations prioritize space constraints at the expense of speed of the operations. The following table illustrates the tradeoffs between the implementations available for matrix decompositions and solving systems of linear equations.

Implementation	Ready	Latency	Area	Sample block or example
Systolic	C	$O(n)$	$O(mn^2)$	"Implement Hardware-Efficient QR Decomposition Using CORDIC in a Systolic Array"
Partial-Systolic	C	$O(m)$	$O(n^2)$	<ul style="list-style-type: none"> Real Partial-Systolic QR Decomposition Real Partial-Systolic Matrix Solve Using QR Decomposition
Partial-Systolic with Forgetting Factor	C	$O(n)$	$O(n^2)$	"Fixed-Point HDL-Optimized Minimum-Variance Distortionless-Response (MVDR) Beamformer"
Burst	$O(n)$	$O(mn^2)$	$O(n)$	<ul style="list-style-type: none"> Real Burst QR Decomposition Real Burst Matrix Solve Using QR Decomposition

Where C is a constant proportional to the word length of the data, m is the number of rows in matrix A , and n is the number of columns in matrix A .

Extended Capabilities

C/C++ Code Generation

Generate C and C++ code using Simulink® Coder™.

Slope-bias representation is not supported for fixed-point data types.

HDL Code Generation

Generate Verilog and VHDL code for FPGA and ASIC designs using HDL Coder™.

HDL Coder provides additional configuration options that affect HDL implementation and synthesized logic.

HDL Architecture

This block has a single, default HDL architecture.

HDL Block Properties

General	
ConstrainedOutputPipeline	Number of registers to place at the outputs by moving existing delays within your design. Distributed pipelining does not redistribute these registers. The default is 0. For more details, see “ConstrainedOutputPipeline” (HDL Coder).
InputPipeline	Number of input pipeline stages to insert in the generated code. Distributed pipelining and constrained output pipelining can move these registers. The default is 0. For more details, see “InputPipeline” (HDL Coder).
OutputPipeline	Number of output pipeline stages to insert in the generated code. Distributed pipelining and constrained output pipelining can move these registers. The default is 0. For more details, see “OutputPipeline” (HDL Coder).

Restrictions

Supports fixed-point data types only.

Fixed-Point Conversion

Design and simulate fixed-point systems using Fixed-Point Designer™.

A and B must be signed, use binary-point scaling, and have the same word length. Slope-bias representation is not supported for fixed-point data types.

See Also

Blocks

Complex Partial-Systolic Matrix Solve Using Q-less QR Decomposition with Forgetting Factor |
Complex Burst Matrix Solve Using Q-less QR Decomposition | Real Partial-Systolic Matrix Solve
Using Q-less QR Decomposition

Functions

`fixed.qlessQRMatrixSolve`

Introduced in R2020b

Complex Partial-Systolic Matrix Solve Using Q-less QR Decomposition with Forgetting Factor

Compute the value of X in $A'AX = B$ for complex-valued matrices with infinite number of rows using Q-less QR decomposition

Library: Fixed-Point Designer HDL Support / Matrices and Linear Algebra / Linear System Solvers

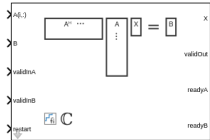

Description

The Complex Partial-Systolic Matrix Solve Using Q-less QR Decomposition with Forgetting Factor block solves the system of linear equations, $A'AX = B$, using Q-less QR decomposition, where A and B are complex-valued matrices. A is an infinitely tall matrix representing streaming data.

Ports

Input

A(i, :) — Rows of matrix A
vector

Rows of matrix A , specified as a vector. A is an m -by- n matrix where $m \geq 2$ and $m \geq n$. If B is single or double, A must be the same data type as B . If A is a fixed-point data type, A must be signed, use binary-point scaling, and have the same word length as B . Slope-bias representation is not supported for fixed-point data types.

Data Types: `single` | `double` | `fixed point`
Complex Number Support: Yes

B — Matrix B
matrix | vector

Matrix B , specified as a vector or a matrix. B is an m -by- p matrix where $m \geq 2$. If A is single or double, B must be the same data type as A . If B is a fixed-point data type, B must be signed, use binary-point scaling, and have the same word length as A . Slope-bias representation is not supported for fixed-point data types.

Data Types: `single` | `double` | `fixed point`

validInA — Whether A input is valid
Boolean scalar

Whether **A(i, :)** input is valid, specified as a Boolean scalar. This control signal indicates when the data from the **A(i, :)** input port is valid. When this value is 1 (`true`) and the **readyA** value is 1 (`true`), the block captures the values at the **A(i, :)** input port. When this value is 0 (`false`), the block ignores the input samples.

After sending a `true` **validInA** signal, there may be some delay before **readyA** is set to `false`. To ensure all data is processed, you must wait until **readyA** is set to `false` before sending another `true` **validInA** signal.

Data Types: Boolean

validInB — Whether input B is valid

Boolean scalar

Whether input **B** is valid, specified as a Boolean scalar. This control signal indicates when the data from the **B** input port is valid. When this value is 1 (`true`) and the **readyB** value is 1 (`true`), the block captures the values at the **B** input port. When this value is 0 (`false`), the block ignores the input samples.

After sending a `true` **validInB** signal, there may be some delay before **readyB** is set to `false`. To ensure all data is processed, you must wait until **readyB** is set to `false` before sending another `true` **validInB** signal.

Data Types: Boolean

restart — Whether to clear internal states

Boolean scalar

Whether to clear internal states, specified as a Boolean scalar. When this value is 1 (`true`), the block stops the current calculation and clears all internal states. When this value is 0 (`false`) and the **validInA** and **validInB** values are 1 (`true`), the block begins a new subframe.

Data Types: Boolean

Output

X — Matrix X

matrix | vector

Matrix *X*, returned as a matrix or vector.

Data Types: single | double | fixed point

validOut — Whether output data is valid

Boolean scalar

Whether the output data is valid, returned as a Boolean scalar. This control signal indicates when the data at the output port **X** is valid. When this value is 1 (`true`), the block has successfully computed a row of *X*. When this value is 0 (`false`), the output data is not valid.

Data Types: Boolean

readyA — Whether block is ready for input A

Boolean scalar

Whether the block is ready for input A, returned as a Boolean scalar. This control signal indicates when the block is ready for new input data. When this value is 1 (`true`) and **validInA** value is 1 (`true`), the block accepts input data in the next time step. When this value is 0 (`false`), the block ignores input data in the next time step.

After sending a `true` **validInA** signal, there may be some delay before **readyA** is set to `false`. To ensure all data is processed, you must wait until **readyA** is set to `false` before sending another `true` **validInA** signal.

Data Types: Boolean

readyB — Whether block is ready for input B

Boolean scalar

Whether the block is ready for input B, returned as a Boolean scalar. This control signal indicates when the block is ready for new input data. When this value is 1 (`true`) and **validInB** value is 1 (`true`), the block accepts input data in the next time step. When this value is 0 (`false`), the block ignores input data in the next time step.

After sending a `true` **validInB** signal, there may be some delay before **readyB** is set to `false`. To ensure all data is processed, you must wait until **readyB** is set to `false` before sending another `true` **validInB** signal.

Data Types: Boolean

Parameters

Number of columns in matrix A and rows in matrix B — Number of columns in matrix A and rows in matrix B

4 (default) | positive integer-valued scalar

Number of columns in matrix *A* and rows in matrix *B*, specified as a positive integer-valued scalar.

Programmatic Use

Block Parameter: *n*

Type: character vector

Values: positive integer-valued scalar

Default: 4

Number of columns in matrix B — Number of columns in matrix B

1 (default) | positive integer-valued scalar

Number of columns in matrix *B*, specified as a positive integer-valued scalar.

Programmatic Use

Block Parameter: *p*

Type: character vector

Values: positive integer-valued scalar

Default: 1

Forgetting factor — Forgetting factor applied after each row of the matrix is factored

0.99 (default) | real positive scalar

Forgetting factor applied after each row of the matrix is factored, specified as a real positive scalar. The output is updated as each row of *A* is input indefinitely.

Programmatic Use

Block Parameter: `forgettingFactor`

Type: character vector

Values: positive integer-valued scalar

Default: 0.99

Output datatype — Data type of output matrix X

`fixdt(1,18,14)` (default) | `double` | `single` | `fixdt(1,16,0)` | `<data type expression>`

Data type of the output matrix X , specified as `fixdt(1,18,14)`, `double`, `single`, `fixdt(1,16,0)`, or as a user-specified data type expression. The type can be specified directly, or expressed as a data type object such as `Simulink.NumericType`.

Programmatic Use

Block Parameter: `OutputType`

Type: character vector

Values: `'fixdt(1,18,14)'` | `'double'` | `'single'` | `'fixdt(1,16,0)'` | `'<data type expression>'`

Default: `'fixdt(1,18,14)'`

Algorithms

Choosing the Implementation Method

Partial-systolic implementations prioritize speed of computations over space constraints, while burst implementations prioritize space constraints at the expense of speed of the operations. The following table illustrates the tradeoffs between the implementations available for matrix decompositions and solving systems of linear equations.

Implementation	Ready	Latency	Area	Sample block or example
Systolic	C	$O(n)$	$O(mn^2)$	“Implement Hardware-Efficient QR Decomposition Using CORDIC in a Systolic Array”
Partial-Systolic	C	$O(m)$	$O(n^2)$	<ul style="list-style-type: none"> Real Partial-Systolic QR Decomposition Real Partial-Systolic Matrix Solve Using QR Decomposition
Partial-Systolic with Forgetting Factor	C	$O(n)$	$O(n^2)$	“Fixed-Point HDL-Optimized Minimum-Variance Distortionless-Response (MVDR) Beamformer”

Implementation	Ready	Latency	Area	Sample block or example
Burst	$O(n)$	$O(mn^2)$	$O(n)$	<ul style="list-style-type: none"> Real Burst QR Decomposition Real Burst Matrix Solve Using QR Decomposition

Where C is a constant proportional to the word length of the data, m is the number of rows in matrix A , and n is the number of columns in matrix A .

Extended Capabilities

C/C++ Code Generation

Generate C and C++ code using Simulink® Coder™.

Slope-bias representation is not supported for fixed-point data types.

HDL Code Generation

Generate Verilog and VHDL code for FPGA and ASIC designs using HDL Coder™.

HDL Coder provides additional configuration options that affect HDL implementation and synthesized logic.

HDL Architecture

This block has a single, default HDL architecture.

HDL Block Properties

General	
ConstrainedOutputPipeline	Number of registers to place at the outputs by moving existing delays within your design. Distributed pipelining does not redistribute these registers. The default is 0. For more details, see “ConstrainedOutputPipeline” (HDL Coder).
InputPipeline	Number of input pipeline stages to insert in the generated code. Distributed pipelining and constrained output pipelining can move these registers. The default is 0. For more details, see “InputPipeline” (HDL Coder).
OutputPipeline	Number of output pipeline stages to insert in the generated code. Distributed pipelining and constrained output pipelining can move these registers. The default is 0. For more details, see “OutputPipeline” (HDL Coder).

Restrictions

Supports fixed-point data types only.

Fixed-Point Conversion

Design and simulate fixed-point systems using Fixed-Point Designer™.

A and B must be signed, use binary-point scaling, and have the same word length. Slope-bias representation is not supported for fixed-point data types.

See Also**Blocks**

[Complex Partial-Systolic Q-less QR Decomposition](#) | [Complex Burst Q-less QR Decomposition](#) | [Real Partial-Systolic Matrix Solve Using Q-less QR Decomposition with Forgetting Factor](#) | [Real Partial-Systolic Q-less QR Decomposition with Forgetting Factor](#)

Functions

`fixed.qlessQRMatrixSolve`

Introduced in R2020b

Complex Partial-Systolic Matrix Solve Using QR Decomposition

Compute value of x in $Ax = B$ for complex-valued matrices using QR decomposition

Library: Fixed-Point Designer HDL Support / Matrices and Linear Algebra / Linear System Solvers

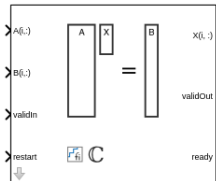

Description

The Complex Partial-Systolic Matrix Solve Using QR Decomposition block solves the system of linear equations $Ax = B$ using QR decomposition, where A and B are complex-valued matrices. To compute $x = A^{-1}B$, set B to be the identity matrix.

Ports

Input

A(i, :) — Rows of matrix A
vector

Rows of matrix A , specified as a vector. A is an m -by- n matrix where $m \geq 2$ and $m \geq n$. If B is single or double, A must be the same data type as B . If A is a fixed-point data type, A must be signed, use binary-point scaling, and have the same word length as B . Slope-bias representation is not supported for fixed-point data types.

Data Types: `single` | `double` | `fixed point`
Complex Number Support: Yes

B(i, :) — Rows of matrix B
vector

Rows of matrix B , specified as a vector. B is an m -by- p matrix where $m \geq 2$. If A is single or double, B must be the same data type as A . If B is a fixed-point data type, B must be signed, use binary-point scaling, and have the same word length as A . Slope-bias representation is not supported for fixed-point data types.

Data Types: `single` | `double` | `fixed point`

validIn — Whether inputs are valid
Boolean scalar

Whether inputs are valid, specified as a Boolean scalar. This control signal indicates when the data from the **A(i,:)** and **B(i,:)** input ports are valid. When this value is 1 (true) and the **ready** value is 1 (true), the block captures the values at the **A(i,:)** and **B(i,:)** input ports. When this value is 0 (false), the block ignores the input samples.

After sending a `true` **validIn** signal, there may be some delay before **ready** is set to `false`. To ensure all data is processed, you must wait until **ready** is set to `false` before sending another `true` **validIn** signal.

Data Types: Boolean

restart — Whether to clear internal states

Boolean scalar

Whether to clear internal states, specified as a Boolean scalar. When this value is 1 (`true`), the block stops the current calculation and clears all internal states. When this value is 0 (`false`) and the **validIn** value is 1 (`true`), the block begins a new subframe.

Data Types: Boolean

Output

X(i, :) — Rows of matrix *X*

scalar | vector

Rows of matrix *X*, returned as a scalar or vector.

Data Types: single | double | fixed point

validOut — Whether output data is valid

Boolean scalar

Whether the output data is valid, returned as a Boolean scalar. This control signal indicates when the data at the output port **X(i,:)** is valid. When this value is 1 (`true`), the block has successfully computed a row of matrix *X*. When this value is 0 (`false`), the output data is not valid.

Data Types: Boolean

ready — Whether block is ready

Boolean scalar

Whether the block is ready, returned as a Boolean scalar. This control signal indicates when the block is ready for new input data. When this value is 1 (`true`) and the **validIn** value is 1 (`true`), the block accepts input data in the next time step. When this value is 0 (`false`), the block ignores input data in the next time step.

After sending a `true` **validIn** signal, there may be some delay before **ready** is set to `false`. To ensure all data is processed, you must wait until **ready** is set to `false` before sending another `true` **validIn** signal.

Data Types: Boolean

Parameters

Number of rows in matrices A and B — Number of rows in input matrices *A* and *B*

4 (default) | positive integer-valued scalar

Number of rows in input matrices *A* and *B*, specified as a positive integer-valued scalar.

Programmatic Use

Block Parameter: *m*

Type: character vector
Values: positive integer-valued scalar
Default: 4

Number of columns in matrix A — Number of columns in input matrix A
 4 (default) | positive integer-valued scalar

Number of columns in input matrix *A*, specified as a positive integer-valued scalar.

Programmatic Use
Block Parameter: n
Type: character vector
Values: positive integer-valued scalar
Default: 4

Number of columns in matrix B — Number of columns in input matrix B
 1 (default) | positive integer-valued scalar

Number of columns in input matrix *B*, specified as a positive integer-valued scalar.

Programmatic Use
Block Parameter: p
Type: character vector
Values: positive integer-valued scalar
Default: 1

Regularization parameter — Regularization parameter
 0 (default) | non-negative scalar

Regularization parameter, specified as a non-negative scalar. Small, positive values of the regularization parameter can improve the conditioning of the problem and reduce the variance of the estimates. While biased, the reduced variance of the estimate often results in a smaller mean squared error when compared to least-squares estimates.

Programmatic Use
Block Parameter: k
Type: character vector
Values: positive integer-valued scalar
Default: 0

Output datatype — Data type of output matrix X
 fixdt(1,18,14) (default) | double | single | fixdt(1,16,0) | <data type expression>

Data type of the output matrix *X*, specified as `fixdt(1,18,14)`, `double`, `single`, `fixdt(1,16,0)`, or as a user-specified data type expression. The type can be specified directly, or expressed as a data type object such as `Simulink.NumericType`.

Programmatic Use
Block Parameter: OutputType
Type: character vector
Values: 'fixdt(1,18,14)' | 'double' | 'single' | 'fixdt(1,16,0)' | '<data type expression>'
Default: 'fixdt(1,18,14)'

Algorithms

Choosing the Implementation Method

Partial-systolic implementations prioritize speed of computations over space constraints, while burst implementations prioritize space constraints at the expense of speed of the operations. The following table illustrates the tradeoffs between the implementations available for matrix decompositions and solving systems of linear equations.

Implementation	Ready	Latency	Area	Sample block or example
Systolic	C	$O(n)$	$O(mn^2)$	"Implement Hardware-Efficient QR Decomposition Using CORDIC in a Systolic Array"
Partial-Systolic	C	$O(m)$	$O(n^2)$	<ul style="list-style-type: none"> Real Partial-Systolic QR Decomposition Real Partial-Systolic Matrix Solve Using QR Decomposition
Partial-Systolic with Forgetting Factor	C	$O(n)$	$O(n^2)$	"Fixed-Point HDL-Optimized Minimum-Variance Distortionless-Response (MVDR) Beamformer"
Burst	$O(n)$	$O(mn^2)$	$O(n)$	<ul style="list-style-type: none"> Real Burst QR Decomposition Real Burst Matrix Solve Using QR Decomposition

Where C is a constant proportional to the word length of the data, m is the number of rows in matrix A , and n is the number of columns in matrix A .

Extended Capabilities

C/C++ Code Generation

Generate C and C++ code using Simulink® Coder™.

Slope-bias representation is not supported for fixed-point data types.

HDL Code Generation

Generate Verilog and VHDL code for FPGA and ASIC designs using HDL Coder™.

HDL Coder provides additional configuration options that affect HDL implementation and synthesized logic.

HDL Architecture

This block has a single, default HDL architecture.

HDL Block Properties

General	
ConstrainedOutputPipeline	Number of registers to place at the outputs by moving existing delays within your design. Distributed pipelining does not redistribute these registers. The default is 0. For more details, see “ConstrainedOutputPipeline” (HDL Coder).
InputPipeline	Number of input pipeline stages to insert in the generated code. Distributed pipelining and constrained output pipelining can move these registers. The default is 0. For more details, see “InputPipeline” (HDL Coder).
OutputPipeline	Number of output pipeline stages to insert in the generated code. Distributed pipelining and constrained output pipelining can move these registers. The default is 0. For more details, see “OutputPipeline” (HDL Coder).

Restrictions

Supports fixed-point data types only.

Fixed-Point Conversion

Design and simulate fixed-point systems using Fixed-Point Designer™.

A and B must be signed, use binary-point scaling, and have the same word length. Slope-bias representation is not supported for fixed-point data types.

See Also

Complex Burst Matrix Solve Using QR Decomposition | Complex Partial-Systolic Matrix Solve Using Q-less QR Decomposition | Real Partial-Systolic Matrix Solve Using QR Decomposition

Introduced in R2020b

Complex Partial-Systolic Q-less QR Decomposition

Q-less QR decomposition for complex-valued matrices

Library: Fixed-Point Designer HDL Support / Matrices and Linear Algebra / Matrix Factorizations

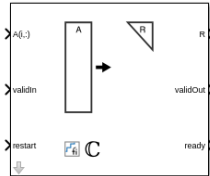

Description

The Complex Partial-Systolic Q-less QR Decomposition block uses QR decomposition to compute the economy size upper-triangular R factor of the QR decomposition $A = QR$, where A is a complex-valued matrix, without computing Q . The solution to $A'Ax = B$ is $x = R \setminus R' \setminus b$.

Ports

Input

A(i, :) — Rows of matrix A
vector

Rows of matrix A , specified as a vector. A is an m -by- n matrix where $m \geq 2$ and $n \geq 2$. If B is single or double, A must be the same data type as B . If A is a fixed-point data type, A must be signed, use binary-point scaling, and have the same word length as B . Slope-bias representation is not supported for fixed-point data types.

Data Types: `single` | `double` | `fixed point`
Complex Number Support: Yes

validIn — Whether inputs are valid

Boolean scalar

Whether inputs are valid, specified as a Boolean scalar. This control signal indicates when the data at the **A(i,:)** input port is valid. When this value is 1 (`true`) and the value at **ready** is 1 (`true`), the block captures the values at the **A(i,:)** input port. When this value is 0 (`false`), the block ignores the input samples.

After sending a `true` **validIn** signal, there may be some delay before **ready** is set to `false`. To ensure all data is processed, you must wait until **ready** is set to `false` before sending another `true` **validIn** signal.

Data Types: `Boolean`

restart — Whether to clear internal states

Boolean scalar

Whether to clear internal states, specified as a Boolean scalar. When this value is 1 (`true`), the block stops the current calculation and clears all internal states. When this value is 0 (`false`) and the **validIn** value is 1 (`true`), the block begins a new subframe.

Data Types: Boolean

Output

R — Matrix *R*

scalar | vector

Economy size QR decomposition matrix *R*, returned as a scalar or vector. *R* is an upper triangular matrix. *R* has the same data type as *A*.

Data Types: single | double | fixed point

validOut — Whether output data is valid

Boolean scalar

Whether the output data is valid, specified as a Boolean scalar. This control signal indicates when the data at output port **R** is valid. When this value is 1 (`true`), the block has successfully computed the matrix *R*. When this value is 0 (`false`), the output data is not valid.

Data Types: Boolean

ready — Whether block is ready

Boolean scalar

Whether the block is ready, returned as a Boolean scalar. This control signal indicates when the block is ready for new input data. When this value is 1 (`true`) and the **validIn** value is 1 (`true`), the block accepts input data in the next time step. When this value is 0 (`false`), the block ignores input data in the next time step.

After sending a `true` **validIn** signal, there may be some delay before **ready** is set to `false`. To ensure all data is processed, you must wait until **ready** is set to `false` before sending another `true` **validIn** signal.

Data Types: Boolean

Parameters

Number of rows in matrix *A* — Number of rows in input matrix *A*

4 (default) | positive integer-valued scalar

Number of rows in input matrix *A*, specified as a positive integer-valued scalar.

Programmatic Use

Block Parameter: *m*

Type: character vector

Values: positive integer-valued scalar

Default: 4

Number of columns in matrix *A* — Number of columns in input matrix *A*

4 (default) | positive integer-valued scalar

Number of columns in input matrix *A*, specified as a positive integer-valued scalar.

Programmatic Use**Block Parameter:** n **Type:** character vector**Values:** positive integer-valued scalar**Default:** 4**Algorithms****Choosing the Implementation Method**

Partial-systolic implementations prioritize speed of computations over space constraints, while burst implementations prioritize space constraints at the expense of speed of the operations. The following table illustrates the tradeoffs between the implementations available for matrix decompositions and solving systems of linear equations.

Implementation	Ready	Latency	Area	Sample block or example
Systolic	C	$O(n)$	$O(mn^2)$	"Implement Hardware-Efficient QR Decomposition Using CORDIC in a Systolic Array"
Partial-Systolic	C	$O(m)$	$O(n^2)$	<ul style="list-style-type: none"> Real Partial-Systolic QR Decomposition Real Partial-Systolic Matrix Solve Using QR Decomposition
Partial-Systolic with Forgetting Factor	C	$O(n)$	$O(n^2)$	"Fixed-Point HDL-Optimized Minimum-Variance Distortionless-Response (MVDR) Beamformer"
Burst	$O(n)$	$O(mn^2)$	$O(n)$	<ul style="list-style-type: none"> Real Burst QR Decomposition Real Burst Matrix Solve Using QR Decomposition

Where C is a constant proportional to the word length of the data, m is the number of rows in matrix A , and n is the number of columns in matrix A .

Block Timing

The following table provides details on the timing for the QR decomposition blocks.

Block	validIn to ready (c cycles)	validIn to validOut (v cycles)
Real Partial-Systolic QR Decomposition	$c = w + 8$	$v = c(m + n - 1)$
Complex Partial-Systolic QR Decomposition	$c = 2w + 15$	$v = c(m + n - 1)$
Real Partial-Systolic Q-less QR Decomposition	$c = w + 8$	$v = c(m + n - 1)$
Complex Partial-Systolic Q-less QR Decomposition	$c = 2w + 15$	$v = c(m + n - 1)$
Real Partial-Systolic Q-less QR Decomposition with Forgetting Factor	$c = w + 8$	$v = c(2n - 1)$
Complex Partial-Systolic Q-less QR Decomposition with Forgetting Factor	$c = 2w + 15$	$v = c(2n - 1)$

In the table, m represents the number of rows in matrix A , and n is the number of columns in matrix A . w represents the word length of A .

- If the data type of A is fixed point, then w is the word length.
- If the data type of A is double, then w is 53.
- If the data type of A is single, then w is 24.

Extended Capabilities

C/C++ Code Generation

Generate C and C++ code using Simulink® Coder™.

Slope-bias representation is not supported for fixed-point data types.

HDL Code Generation

Generate Verilog and VHDL code for FPGA and ASIC designs using HDL Coder™.

HDL Coder provides additional configuration options that affect HDL implementation and synthesized logic.

HDL Architecture

This block has a single, default HDL architecture.

HDL Block Properties

General	
ConstrainedOutputPipeline	Number of registers to place at the outputs by moving existing delays within your design. Distributed pipelining does not redistribute these registers. The default is 0. For more details, see “ConstrainedOutputPipeline” (HDL Coder).

General	
InputPipeline	Number of input pipeline stages to insert in the generated code. Distributed pipelining and constrained output pipelining can move these registers. The default is 0. For more details, see “InputPipeline” (HDL Coder).
OutputPipeline	Number of output pipeline stages to insert in the generated code. Distributed pipelining and constrained output pipelining can move these registers. The default is 0. For more details, see “OutputPipeline” (HDL Coder).

Restrictions

Supports fixed-point data types only.

Fixed-Point Conversion

Design and simulate fixed-point systems using Fixed-Point Designer™.

A must be signed and use binary-point scaling. Slope-bias representation is not supported for fixed-point data types.

See Also**Blocks**

Complex Partial-Systolic Q-less QR Decomposition with Forgetting Factor | Complex Burst Q-less QR Decomposition | Real Partial-Systolic Q-less QR Decomposition

Functions

`fixed.qlessQR`

Introduced in R2020b

Complex Partial-Systolic Q-less QR Decomposition with Forgetting Factor

Q-less QR decomposition for complex-valued matrices with infinite number of rows

Library: Fixed-Point Designer HDL Support / Matrices and Linear Algebra / Matrix Factorizations

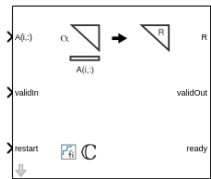

Description

The Complex Partial-Systolic Q-less QR Decomposition with Forgetting Factor block uses QR decomposition to compute the economy size upper-triangular R factor of the QR decomposition $A = QR$, without computing Q . A is an infinitely tall complex-valued matrix representing streaming data.

The solution to $A'Ax = B$ is $x = R \setminus R' \setminus b$.

Ports

Input

$A(i, :)$ — Rows of matrix A

vector

Rows of matrix A , specified as a vector. A is an m -by- n matrix where $m \geq 2$ and $m \geq n$. If B is single or double, A must be the same data type as B . If A is a fixed-point data type, A must be signed, use binary-point scaling, and have the same word length as B . Slope-bias representation is not supported for fixed-point data types.

Data Types: single | double | fixed point

Complex Number Support: Yes

validIn — Whether inputs are valid

Boolean scalar

Whether inputs are valid, specified as a Boolean scalar. This control signal indicates when the data at the $A(i,:)$ input port is valid. When this value is 1 (**true**) and the value at **ready** is 1 (**true**), the block captures the values at the $A(i,:)$ input port. When this value is 0 (**false**), the block ignores the input samples.

After sending a **true** **validIn** signal, there may be some delay before **ready** is set to **false**. To ensure all data is processed, you must wait until **ready** is set to **false** before sending another **true** **validIn** signal.

Data Types: Boolean

restart — Whether to clear internal states

Boolean scalar

Whether to clear internal states, specified as a Boolean scalar. When this value is 1 (`true`), the block stops the current calculation and clears all internal states. When this value is 0 (`false`) and the **validIn** value is 1 (`true`), the block begins a new subframe.

Data Types: Boolean

Output

R — Matrix *R*

scalar | vector

Economy size QR decomposition matrix *R*, returned as a scalar or vector. *R* is an upper triangular matrix. *R* has the same data type as *A*.

Data Types: single | double | fixed point

validOut — Whether output data is valid

Boolean scalar

Whether the output data is valid, specified as a Boolean scalar. This control signal indicates when the data at output port **R** is valid. When this value is 1 (`true`), the block has successfully computed the matrix *R*. When this value is 0 (`false`), the output data is not valid.

Data Types: Boolean

ready — Whether block is ready

Boolean scalar

Whether the block is ready, returned as a Boolean scalar. This control signal indicates when the block is ready for new input data. When this value is 1 (`true`) and the **validIn** value is 1 (`true`), the block accepts input data in the next time step. When this value is 0 (`false`), the block ignores input data in the next time step.

After sending a `true` **validIn** signal, there may be some delay before **ready** is set to `false`. To ensure all data is processed, you must wait until **ready** is set to `false` before sending another `true` **validIn** signal.

Data Types: Boolean

Parameters

Number of columns in matrix A — Number of columns in input matrix A

4 (default) | positive integer-valued scalar

Number of columns in input matrix *A*, specified as a positive integer-valued scalar.

Programmatic Use

Block Parameter: *n*

Type: character vector

Values: positive integer-valued scalar

Default: 4

Forgetting factor — Forgetting factor applied after each row of matrix is factored

0.99 (default) | real positive scalar

Forgetting factor applied after each row of the matrix is factored, specified as a real positive scalar. The output is updated as each row of *A* is input indefinitely.

Programmatic Use**Block Parameter:** forgettingFactor**Type:** character vector**Values:** positive integer-valued scalar**Default:** 0.99**Algorithms****Choosing the Implementation Method**

Partial-systolic implementations prioritize speed of computations over space constraints, while burst implementations prioritize space constraints at the expense of speed of the operations. The following table illustrates the tradeoffs between the implementations available for matrix decompositions and solving systems of linear equations.

Implementation	Ready	Latency	Area	Sample block or example
Systolic	C	$O(n)$	$O(mn^2)$	"Implement Hardware-Efficient QR Decomposition Using CORDIC in a Systolic Array"
Partial-Systolic	C	$O(m)$	$O(n^2)$	<ul style="list-style-type: none"> Real Partial-Systolic QR Decomposition Real Partial-Systolic Matrix Solve Using QR Decomposition
Partial-Systolic with Forgetting Factor	C	$O(n)$	$O(n^2)$	"Fixed-Point HDL-Optimized Minimum-Variance Distortionless-Response (MVDR) Beamformer"
Burst	$O(n)$	$O(mn^2)$	$O(n)$	<ul style="list-style-type: none"> Real Burst QR Decomposition Real Burst Matrix Solve Using QR Decomposition

Where C is a constant proportional to the word length of the data, m is the number of rows in matrix A , and n is the number of columns in matrix A .

Block Timing

The following table provides details on the timing for the QR decomposition blocks.

Block	validIn to ready (c cycles)	validIn to validOut (v cycles)
Real Partial-Systolic QR Decomposition	$c = w + 8$	$v = c(m + n - 1)$
Complex Partial-Systolic QR Decomposition	$c = 2w + 15$	$v = c(m + n - 1)$
Real Partial-Systolic Q-less QR Decomposition	$c = w + 8$	$v = c(m + n - 1)$
Complex Partial-Systolic Q-less QR Decomposition	$c = 2w + 15$	$v = c(m + n - 1)$
Real Partial-Systolic Q-less QR Decomposition with Forgetting Factor	$c = w + 8$	$v = c(2n - 1)$
Complex Partial-Systolic Q-less QR Decomposition with Forgetting Factor	$c = 2w + 15$	$v = c(2n - 1)$

In the table, m represents the number of rows in matrix A , and n is the number of columns in matrix A . w represents the word length of A .

- If the data type of A is fixed point, then w is the word length.
- If the data type of A is double, then w is 53.
- If the data type of A is single, then w is 24.

Extended Capabilities

C/C++ Code Generation

Generate C and C++ code using Simulink® Coder™.

Slope-bias representation is not supported for fixed-point data types.

HDL Code Generation

Generate Verilog and VHDL code for FPGA and ASIC designs using HDL Coder™.

HDL Coder provides additional configuration options that affect HDL implementation and synthesized logic.

HDL Architecture

This block has a single, default HDL architecture.

HDL Block Properties

General	
ConstrainedOutputPipeline	Number of registers to place at the outputs by moving existing delays within your design. Distributed pipelining does not redistribute these registers. The default is 0. For more details, see “ConstrainedOutputPipeline” (HDL Coder).

General	
InputPipeline	Number of input pipeline stages to insert in the generated code. Distributed pipelining and constrained output pipelining can move these registers. The default is 0. For more details, see "InputPipeline" (HDL Coder).
OutputPipeline	Number of output pipeline stages to insert in the generated code. Distributed pipelining and constrained output pipelining can move these registers. The default is 0. For more details, see "OutputPipeline" (HDL Coder).

Restrictions

Supports fixed-point data types only.

Fixed-Point Conversion

Design and simulate fixed-point systems using Fixed-Point Designer™.

A must be signed and use binary-point scaling. Slope-bias representation is not supported for fixed-point data types.

See Also**Blocks**

Complex Partial-Systolic Q-less QR Decomposition | Complex Partial-Systolic QR Decomposition | Complex Burst Q-less QR Decomposition | Real Partial-Systolic Matrix Solve Using Q-less QR Decomposition with Forgetting Factor

Functions

`fixed.qlessQR`

Introduced in R2020b

Complex Partial-Systolic QR Decomposition

QR decomposition for complex-valued matrices

Library: Fixed-Point Designer HDL Support / Matrices and Linear Algebra / Matrix Factorizations

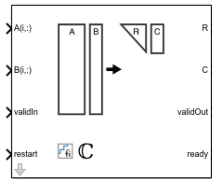

Description

The Complex Partial-Systolic QR Decomposition block uses QR decomposition to compute R and $C = Q'B$, where $QR = A$, and A and B are complex-valued matrices. The least-squares solution to $Ax = B$ is $x = R \setminus C$. R is an upper triangular matrix and Q is an orthogonal matrix. To compute $C = Q'$, set B to be the identity matrix.

Ports

Input

A(i, :) — Rows of matrix A

vector

Rows of matrix A , specified as a vector. A is an m -by- n matrix where $m \geq 2$ and $n \geq 2$. If B is single or double, A must be the same data type as B . If A is a fixed-point data type, A must be signed, use binary-point scaling, and have the same word length as B . Slope-bias representation is not supported for fixed-point data types.

Data Types: `single` | `double` | `fixed point`

Complex Number Support: Yes

B(i, :) — Rows of matrix B

vector

Rows of matrix B , specified as a vector. B is an m -by- p matrix where $m \geq 2$. If A is single or double, B must be the same data type as A . If B is a fixed-point data type, B must be signed, use binary-point scaling, and have the same word length as A . Slope-bias representation is not supported for fixed-point data types.

Data Types: `single` | `double` | `fixed point`

Complex Number Support: Yes

validIn — Whether inputs are valid

Boolean scalar

Whether inputs are valid, specified as a Boolean scalar. This control signal indicates when the data from the **A(i,:)** and **B(i,:)** input ports are valid. When this value is 1 (`true`) and the value at **ready** is 1 (`true`), the block captures the values on the **A(i,:)** and **B(i,:)** input ports. When this value is 0 (`false`), the block ignores the input samples.

After sending a `true` **validIn** signal, there may be some delay before **ready** is set to `false`. To ensure all data is processed, you must wait until **ready** is set to `false` before sending another `true` **validIn** signal.

Data Types: Boolean

restart — Whether to clear internal states

Boolean scalar

Whether to clear internal states, specified as a Boolean scalar. When this value is 1 (`true`), the block stops the current calculation and clears all internal states. When this value is 0 (`false`), and the **validIn** value is 1 (`true`), the block begins a new subframe.

Data Types: Boolean

Output

R — Matrix R

matrix

Economy-size QR decomposition matrix R , returned as a matrix. R is an upper triangular matrix. R has the same data type as A .

Data Types: single | double | fixed point

C — Matrix $C=Q'B$

matrix

Economy-size QR decomposition matrix $C=Q'B$, returned as a matrix or vector. C has the same number of rows as R . C has the same data type as B .

Data Types: single | double | fixed point

validOut — Whether output data is valid

Boolean scalar

Whether the output data is valid, returned as a Boolean scalar. This control signal indicates when the data at output ports **R** and **C** is valid. When this value is 1 (`true`), the block has successfully computed the R and C matrices. When this value is 0 (`false`), the output data is not valid.

Data Types: Boolean

ready — Whether block is ready

Boolean scalar

Whether the block is ready, returned as a Boolean scalar. This control signal indicates when the block is ready for new input data. When this value is 1 (`true`), and the **validIn** value is 1 (`true`), the block accepts input data in the next time step. When this value is 0 (`false`), the block ignores input data in the next time step.

After sending a `true` **validIn** signal, there may be some delay before **ready** is set to `false`. To ensure all data is processed, you must wait until **ready** is set to `false` before sending another `true` **validIn** signal.

Data Types: Boolean

Parameters

Number of rows in matrices A and B — Number of rows in input matrices A and B
4 (default) | positive integer-valued scalar

The number of rows in input matrices A and B , specified as a positive integer-valued scalar.

Programmatic Use

Block Parameter: m

Type: character vector

Values: positive integer-valued scalar

Default: 4

Number of columns in matrix A — Number of columns in input matrix A
4 (default) | positive integer-valued scalar

The number of columns in input matrix A , specified as a positive integer-valued scalar.

Programmatic Use

Block Parameter: n

Type: character vector

Values: positive integer-valued scalar

Default: 4

Number of columns in matrix B — Number of columns in input matrix B
1 (default) | positive integer-valued scalar

The number of columns in input matrix B , specified as a positive integer-valued scalar.

Programmatic Use

Block Parameter: p

Type: character vector

Values: positive integer-valued scalar

Default: 1

Regularization parameter — Regularization parameter
0 (default) | non-negative scalar

Regularization parameter, specified as a non-negative scalar. Small, positive values of the regularization parameter can improve the conditioning of the problem and reduce the variance of the estimates. While biased, the reduced variance of the estimate often results in a smaller mean squared error when compared to least-squares estimates.

Programmatic Use

Block Parameter: k

Type: character vector

Values: positive integer-valued scalar

Default: 0

Algorithms

Choosing the Implementation Method

Partial-systolic implementations prioritize speed of computations over space constraints, while burst implementations prioritize space constraints at the expense of speed of the operations. The following

table illustrates the tradeoffs between the implementations available for matrix decompositions and solving systems of linear equations.

Implementation	Ready	Latency	Area	Sample block or example
Systolic	C	$O(n)$	$O(mn^2)$	“Implement Hardware-Efficient QR Decomposition Using CORDIC in a Systolic Array”
Partial-Systolic	C	$O(m)$	$O(n^2)$	<ul style="list-style-type: none"> • Real Partial-Systolic QR Decomposition • Real Partial-Systolic Matrix Solve Using QR Decomposition
Partial-Systolic with Forgetting Factor	C	$O(n)$	$O(n^2)$	“Fixed-Point HDL-Optimized Minimum-Variance Distortionless-Response (MVDR) Beamformer”
Burst	$O(n)$	$O(mn^2)$	$O(n)$	<ul style="list-style-type: none"> • Real Burst QR Decomposition • Real Burst Matrix Solve Using QR Decomposition

Where C is a constant proportional to the word length of the data, m is the number of rows in matrix A , and n is the number of columns in matrix A .

Block Timing

The following table provides details on the timing for the QR decomposition blocks.

Block	validIn to ready (c cycles)	validIn to validOut (v cycles)
Real Partial-Systolic QR Decomposition	$c = w + 8$	$v = c(m + n - 1)$
Complex Partial-Systolic QR Decomposition	$c = 2w + 15$	$v = c(m + n - 1)$
Real Partial-Systolic Q-less QR Decomposition	$c = w + 8$	$v = c(m + n - 1)$
Complex Partial-Systolic Q-less QR Decomposition	$c = 2w + 15$	$v = c(m + n - 1)$

Block	validIn to ready (c cycles)	validIn to validOut (v cycles)
Real Partial-Systolic Q-less QR Decomposition with Forgetting Factor	$c = w + 8$	$v = c(2n - 1)$
Complex Partial-Systolic Q-less QR Decomposition with Forgetting Factor	$c = 2w + 15$	$v = c(2n - 1)$

In the table, m represents the number of rows in matrix A , and n is the number of columns in matrix A . w represents the word length of A .

- If the data type of A is fixed point, then w is the word length.
- If the data type of A is double, then w is 53.
- If the data type of A is single, then w is 24.

Extended Capabilities

C/C++ Code Generation

Generate C and C++ code using Simulink® Coder™.

Slope-bias representation is not supported for fixed-point data types.

HDL Code Generation

Generate Verilog and VHDL code for FPGA and ASIC designs using HDL Coder™.

HDL Coder provides additional configuration options that affect HDL implementation and synthesized logic.

HDL Architecture

This block has a single, default HDL architecture.

HDL Block Properties

General	
ConstrainedOutputPipeline	Number of registers to place at the outputs by moving existing delays within your design. Distributed pipelining does not redistribute these registers. The default is 0. For more details, see “ConstrainedOutputPipeline” (HDL Coder).
InputPipeline	Number of input pipeline stages to insert in the generated code. Distributed pipelining and constrained output pipelining can move these registers. The default is 0. For more details, see “InputPipeline” (HDL Coder).

General	
OutputPipeline	Number of output pipeline stages to insert in the generated code. Distributed pipelining and constrained output pipelining can move these registers. The default is 0. For more details, see “OutputPipeline” (HDL Coder).

Restrictions

Supports fixed-point data types only.

Fixed-Point Conversion

Design and simulate fixed-point systems using Fixed-Point Designer™.

A and B must be signed, use binary-point scaling, and have the same word length. Slope-bias representation is not supported for fixed-point data types.

See Also**Blocks**

Complex Partial-Systolic Q-less QR Decomposition | Complex Burst QR Decomposition | Real Partial-Systolic QR Decomposition

Functions

`fixed.qrAB`

Introduced in R2020b

Divide by Constant and Round

Divide input by a constant and round to integer

Library: Fixed-Point Designer



Description

The Divide by Constant and Round block outputs the result of dividing the input by a constant and rounds the result to an integer using the specified rounding method.

The Divide by Constant and Round block uses an algorithm that is functionally similar to the Granlund-Montgomery-Warren Method. The division operation is computed via a multiplication by inverse, which generally results in better performance on embedded systems.

Ports

Input

X — Dividend

scalar | vector | matrix | N-D array

Dividend, specified as a scalar, vector, matrix, or N-D array.

Divide by Constant and Round does not support data types with word length greater than 128.

Data Types: single | double | int8 | int16 | int32 | uint8 | uint16 | uint32 | Boolean | fixed point

Output

Y — Result of division and round operation

scalar | vector | matrix | N-D array

Result of division and round operation, returned as a scalar, vector, matrix, or N-D array.

Data Types: single | double | int8 | int16 | int32 | uint8 | uint16 | uint32 | Boolean | fixed point

Parameters

Denominator — Divisor

10 (default) | scalar

Divisor, specified as a positive, real-valued, finite scalar.

Programmatic Use

Block Parameter: Denominator

Type: character vector

Values: MATLAB expression that evaluates to a positive, real-valued, finite fixed point or numeric value

Default: '10'

Data Types: `single` | `double` | `int8` | `int16` | `int32` | `int64` | `uint8` | `uint16` | `uint32` | `uint64` | `Boolean` | `fixed point`

Rounding Method — Rounding method to use

`Floor` (default) | `Ceiling` | `Nearest` | `Zero` | `Convergent`

Rounding method to use, specified as one of these values:

- `Floor` — Round to nearest integer in the direction of negative infinity.
- `Ceiling` — Round to nearest integer in the direction of positive infinity.
- `Nearest` — Round to the nearest integer. Ties are rounded to the nearest integer in the direction of positive infinity.
- `Zero` — Round to the nearest integer in the direction of zero.
- `Convergent` — Round to the nearest integer. Ties are rounded to the nearest even integer.

Programmatic Use

Block Parameter: `RndMeth`

Type: character vector

Values: 'Floor' | 'Ceiling' | 'Nearest' | 'Zero' | 'Convergent'

Default: 'Floor'

Extended Capabilities

C/C++ Code Generation

Generate C and C++ code using Simulink® Coder™.

Slope-bias representation is not supported for fixed-point data types.

Fixed-Point Conversion

Design and simulate fixed-point systems using Fixed-Point Designer™.

Slope-bias representation is not supported for fixed-point data types.

See Also

`Divide` | `Divide by Constant HDL Optimized`

Topics

“Choosing a Rounding Method”

Introduced in R2021a

Divide by Constant HDL Optimized

Divide input by a constant and round to integer and generate optimized HDL code

Library: Fixed-Point Designer HDL Support / Math Operations



Description

The Divide by Constant HDL Optimized block outputs the result of dividing the input by a constant and rounds the result to an integer using the specified rounding method using an HDL-optimized architecture with cycle-true latency.

The Divide by Constant HDL Optimized block uses an algorithm that is functionally similar to the Granlund-Montgomery-Warren Method. The division operation is computed via a multiplication by inverse, which generally results in better performance on embedded systems.

Ports

Input

X — Dividend

real scalar

Dividend, specified as a real scalar.

Data Types: `single` | `double` | `int8` | `int16` | `int32` | `uint8` | `uint16` | `uint32` | `Boolean` | `fixed point`

validIn — Whether input is valid

boolean scalar

Whether input is valid, specified as a Boolean scalar. This control signal indicates when the data from the **X** input port is valid. When this value is 1 (`true`), the block captures the value on the **X** input port. When this value is 0 (`false`), the block ignores the input samples.

Data Types: `Boolean`

Output

Y — Result of division and round operation

scalar

Result of division and round operation, returned as a scalar.

Data Types: `single` | `double` | `int8` | `int16` | `int32` | `uint8` | `uint16` | `uint32` | `Boolean` | `fixed point`

validOut — Whether output data is valid

boolean scalar

Whether the output data is valid, returned as a Boolean scalar. When the value of this control signal is 1 (`true`), the block has successfully computed the output **Y**. When this value is 0 (`false`), the output data is not valid.

Data Types: Boolean

Parameters

Denominator for rational division — Divisor

10 (default) | scalar

Divisor, specified as a positive, real-valued, finite scalar.

Programmatic Use

Block Parameter: Denominator

Type: character vector

Values: MATLAB expression that evaluates to a positive, real-valued, finite fixed point or numeric value

Default: '10'

Data Types: single | double | int8 | int16 | int32 | int64 | uint8 | uint16 | uint32 | uint64 | Boolean | fixed point

Rounding Method — Rounding method to use

Floor (default) | Ceiling | Nearest | Zero | Convergent

Rounding method to use, specified as one of these values:

- **Floor** — Round to nearest integer in the direction of negative infinity.
- **Ceiling** — Round to nearest integer in the direction of positive infinity.
- **Nearest** — Round to the nearest integer. Ties are rounded to the nearest integer in the direction of positive infinity.
- **Zero** — Round to the nearest integer in the direction of zero.
- **Convergent** — Round to the nearest integer. Ties are rounded to the nearest even integer.

Programmatic Use

Block Parameter: RndMeth

Type: character vector

Values: 'Floor' | 'Ceiling' | 'Nearest' | 'Zero' | 'Convergent'

Default: 'Floor'

Tips

The blocks Divide by Constant HDL Optimized, Real Divide HDL Optimized, and Complex Divide HDL Optimized all perform the division operation and generate optimized HDL code.

- Real Divide HDL Optimized and Complex Divide HDL Optimized are based on a CORIDC algorithm. These blocks accept a wide variety of inputs, but will result in greater latency.
- Divide by Constant HDL Optimized accepts only real inputs and a constant divisor. Use of this block consumes DSP slices, but will complete the division operation in fewer cycles and at a higher clock rate.

Extended Capabilities

C/C++ Code Generation

Generate C and C++ code using Simulink® Coder™.

Slope-bias representation is not supported for fixed-point data types.

HDL Code Generation

Generate Verilog and VHDL code for FPGA and ASIC designs using HDL Coder™.

HDL Coder provides additional configuration options that affect HDL implementation and synthesized logic.

HDL Architecture

This block has a single, default HDL architecture.

HDL Block Properties

General	
ConstrainedOutputPipeline	Number of registers to place at the outputs by moving existing delays within your design. Distributed pipelining does not redistribute these registers. The default is 0. For more details, see “ConstrainedOutputPipeline” (HDL Coder).
InputPipeline	Number of input pipeline stages to insert in the generated code. Distributed pipelining and constrained output pipelining can move these registers. The default is 0. For more details, see “InputPipeline” (HDL Coder).
OutputPipeline	Number of output pipeline stages to insert in the generated code. Distributed pipelining and constrained output pipelining can move these registers. The default is 0. For more details, see “OutputPipeline” (HDL Coder).

Restrictions

Slope-bias representation is not supported for fixed-point data types.

Fixed-Point Conversion

Design and simulate fixed-point systems using Fixed-Point Designer™.

Slope-bias representation is not supported for fixed-point data types.

See Also

Divide | Divide by Constant and Round

Topics

“Choosing a Rounding Method”

Introduced in R2021a

Hyperbolic Tangent HDL Optimized

Computes CORDIC-based hyperbolic tangent and generates optimized HDL code

Library: Fixed-Point Designer HDL Support / Math Operations

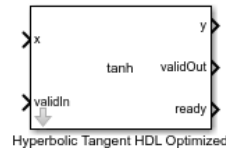

Description

The Hyperbolic Tangent HDL Optimized block returns the hyperbolic tangent of x , computed using a CORDIC-based implementation optimized for HDL code generation.

Ports

Input

x — Angle in radians

real finite scalar

Angle in radians, specified as a real finite scalar. If x is a fixed-point or scaled double data type, x must use binary-point scaling. Slope-bias representation is not supported for fixed-point data types.

Data Types: `single` | `double` | `fixed point`

validIn — Whether input is valid

Boolean scalar

Whether input is valid, specified as a Boolean scalar. This control signal indicates when the data from the x input port is valid. When this value is 1 (`true`), the block captures the value on the x input port. When this value is 0 (`false`), the block ignores the input samples.

Data Types: `Boolean`

Output

y — Hyperbolic tangent of x

scalar

Hyperbolic tangent of the value at x , returned as a scalar. The value at y is the CORDIC-based approximation of the hyperbolic tangent of x . When the input to the function is floating point, the output data type is the same as the input data type. When the input is a fixed-point data type, the output has the same word length as the input and a fraction length equal to 2 less than the word length.

Data Types: `single` | `double` | `fixed point`

validOut — Whether output data is valid

Boolean scalar

Whether the output data is valid, returned as a Boolean scalar. When the value of this control signal is 1 (**true**), the block has successfully computed the output **y**. When this value is 0 (**false**), the output data is not valid.

Data Types: Boolean

ready — Whether block is ready

Boolean scalar

Whether the block is ready, returned as a Boolean scalar. This control signal indicates when the block is ready for new input data. When this value is 1 (**true**), and the **validIn** value is 1 (**true**), the block accepts input data in the next time step. When this value is 0 (**false**), the block ignores input data in the next time step.

Data Types: Boolean

More About

[1] Volder, JE. "The CORDIC Trigonometric Computing Technique." *IRE Transactions on Electronic Computers*. Vol. EC-8, September 1959, pp. 330-334.

[2] Andraka, R. "A survey of CORDIC algorithm for FPGA based computers." *Proceedings of the 1998 ACM/SIGDA sixth international symposium on Field programmable gate arrays*. Feb. 22-24, 1998, pp. 191-200.

[3] Walther, J.S. "A Unified Algorithm for Elementary Functions." Hewlett-Packard Company, Palo Alto. Spring Joint Computer Conference, 1971, pp. 379-386. (from the collection of the Computer History Museum). www.computer.org/csdl/proceedings/afips/1971/5077/00/50770379.pdf

[4] Schelin, Charles W. "Calculator Function Approximation." *The American Mathematical Monthly*. Vol. 90, No. 5, May 1983, pp. 317-325.

Algorithms

CORDIC

CORDIC is an acronym for COordinate Rotation DIgital Computer. The Givens rotation-based CORDIC algorithm is one of the most hardware-efficient algorithms available because it requires only iterative shift-add operations (see References). The CORDIC algorithm eliminates the need for explicit multipliers.

The block automatically determines the number of iterations, **niters**, the CORDIC algorithm performs based on the data type of the input.

Data type of input x	niters
single	23
double	52
fixed point	One less than the word length of x . The minimum number of CORDIC iterations is 7.

Extended Capabilities

C/C++ Code Generation

Generate C and C++ code using Simulink® Coder™.

Slope-bias representation is not supported for fixed-point data types.

HDL Code Generation

Generate Verilog and VHDL code for FPGA and ASIC designs using HDL Coder™.

HDL Coder provides additional configuration options that affect HDL implementation and synthesized logic.

HDL Architecture

This block has a single, default HDL architecture.

HDL Block Properties

General	
ConstrainedOutputPipeline	Number of registers to place at the outputs by moving existing delays within your design. Distributed pipelining does not redistribute these registers. The default is 0. For more details, see “ConstrainedOutputPipeline” (HDL Coder).
InputPipeline	Number of input pipeline stages to insert in the generated code. Distributed pipelining and constrained output pipelining can move these registers. The default is 0. For more details, see “InputPipeline” (HDL Coder).
OutputPipeline	Number of output pipeline stages to insert in the generated code. Distributed pipelining and constrained output pipelining can move these registers. The default is 0. For more details, see “OutputPipeline” (HDL Coder).

Restrictions

Supports fixed-point data types only.

Fixed-Point Conversion

Design and simulate fixed-point systems using Fixed-Point Designer™.

x must use binary-point scaling. Slope-bias representation is not supported for fixed-point data types.

See Also

Functions

cordictanh

Introduced in R2020a

Modulo by Constant

Perform modulo operation with a constant denominator

Library: Fixed-Point Designer



Description

The Modulo by Constant block performs the modulo operation (remainder after division) with a constant denominator.

The Modulo by Constant block uses an algorithm that is functionally similar to a Barrett Reduction. The division operation is computed via a multiplication by inverse, which generally results in better performance on embedded systems.

Ports

Input

X — Dividend

real scalar

Dividend, specified as a real scalar.

If **X** is a fixed-point data type, it must use binary-point scaling.

Data Types: `single` | `double` | `int8` | `int16` | `int32` | `int64` | `uint8` | `uint16` | `uint32` | `fixed point`

Output

Y — Result of modulus operation

scalar

Result of modulus operation, returned as a scalar.

Data Types: `single` | `double` | `int8` | `int16` | `int32` | `int64` | `uint8` | `uint16` | `uint32` | `fixed point`

Parameters

Denominator for Modulo Problem — Divisor

10 (default) | scalar

Divisor to use for the modulus operation, specified as a positive, real-valued, finite scalar.

Programmatic Use

Block Parameter: Denominator

Type: character vector

Values: MATLAB expression that evaluates to a positive, real-valued, finite fixed point or numeric value

Default: '10'

Data Types: `single` | `double` | `int8` | `int16` | `int32` | `int64` | `uint8` | `uint16` | `uint32` | `uint64` | `Boolean` | `fixed point`

Extended Capabilities

C/C++ Code Generation

Generate C and C++ code using Simulink® Coder™.

Slope-bias representation is not supported for fixed-point data types.

Fixed-Point Conversion

Design and simulate fixed-point systems using Fixed-Point Designer™.

Slope-bias representation is not supported for fixed-point data types.

See Also

Modulo by Constant HDL Optimized

Introduced in R2021a

Modulo by Constant HDL Optimized

Perform mod operation with a constant denominator and generate optimized HDL code

Library: Fixed-Point Designer HDL Support / Math Operations

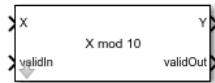

Description

The Modulo by Constant HDL Optimized block performs the modulo operation (remainder after division) with a constant denominator using an HDL-optimized architecture with cycle-true latency.

The Modulo by Constant block uses an algorithm that is functionally similar to a Barrett Reduction. The division operation is computed via a multiplication by inverse, which generally results in better performance on embedded systems.

Ports

Input

X — Dividend

real scalar

Dividend, specified as a real scalar.

If **X** is a fixed-point data type, it must use binary-point scaling.

Data Types: `single` | `double` | `int8` | `int16` | `int32` | `int64` | `uint8` | `uint16` | `uint32` | `fixed point`

validIn — Whether input is valid

boolean scalar

Whether input is valid, specified as a Boolean scalar. This control signal indicates when the data from the **X** input port is valid. When this value is 1 (`true`), the block captures the value on the **X** input port. When this value is 0 (`false`), the block ignores the input samples.

Data Types: `Boolean`

Output

Y — Result of modulus operation

scalar

Result of modulus operation, returned as a scalar.

Data Types: `single` | `double` | `int8` | `int16` | `int32` | `int64` | `uint8` | `uint16` | `uint32` | `fixed point`

validOut — Whether output data is valid

boolean scalar

Whether the output data is valid, returned as a Boolean scalar. When the value of this control signal is 1 (`true`), the block has successfully computed the output **Y**. When this value is 0 (`false`), the output data is not valid.

Data Types: Boolean

Parameters

Denominator — Divisor

10 (default) | real scalar

Divisor to use for the modulus operation, specified as a positive, real-valued, finite scalar.

Programmatic Use

Block Parameter: Denominator

Type: character vector

Values: MATLAB expression that evaluates to a positive, real-valued, finite fixed point or numeric value

Default: '10'

Data Types: single | double | int8 | int16 | int32 | int64 | uint8 | uint16 | uint32 | uint64 | Boolean | fixed point

Extended Capabilities

C/C++ Code Generation

Generate C and C++ code using Simulink® Coder™.

Slope-bias representation is not supported for fixed-point data types.

HDL Code Generation

Generate Verilog and VHDL code for FPGA and ASIC designs using HDL Coder™.

HDL Coder provides additional configuration options that affect HDL implementation and synthesized logic.

HDL Architecture

This block has a single, default HDL architecture.

HDL Block Properties

General	
ConstrainedOutputPipeline	Number of registers to place at the outputs by moving existing delays within your design. Distributed pipelining does not redistribute these registers. The default is 0. For more details, see “ConstrainedOutputPipeline” (HDL Coder).
InputPipeline	Number of input pipeline stages to insert in the generated code. Distributed pipelining and constrained output pipelining can move these registers. The default is 0. For more details, see “InputPipeline” (HDL Coder).

General	
OutputPipeline	Number of output pipeline stages to insert in the generated code. Distributed pipelining and constrained output pipelining can move these registers. The default is 0. For more details, see “OutputPipeline” (HDL Coder).

Restrictions

Slope-bias representation is not supported for fixed-point data types.

Fixed-Point Conversion

Design and simulate fixed-point systems using Fixed-Point Designer™.

Slope-bias representation is not supported for fixed-point data types.

See Also

Modulo by Constant

Introduced in R2021a

Normalized Reciprocal HDL Optimized

Computes normalized reciprocal and generates optimized HDL code

Library: Fixed-Point Designer HDL Support / Math Operations

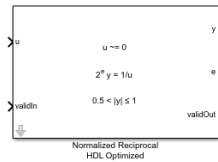

Description

The Normalized Reciprocal HDL Optimized block computes the normalized reciprocal of u , returned as y and t such that $0.5 < |y| \leq 1$ and $2^e y = 1/u$.

- If $u = 0$ and u is a fixed-point or scaled-double data type, then $y = 2 - \text{eps}(y)$ and $e = 2^{\text{nextpow2}(w) - w} + f$, where w is the word length of u and f is the fraction length of u .
- If $u = 0$ and u is a floating-point data type, then $y = \text{Inf}$ and $t = 1$.

Ports

Input

u — Value to take normalized reciprocal of
real scalar

Value to take the normalized reciprocal of, specified as a real scalar.

Data Types: `single` | `double` | `fixed point`

validIn — Whether input is valid
Boolean scalar

Whether input is valid, specified as a Boolean scalar. This control signal indicates when the data from the **u** input port is valid. When this value is 1 (`true`), the block captures the value at the **u** input port. When this value is 0 (`false`), the block ignores the input samples.

Data Types: `Boolean`

Output

y — Normalized reciprocal
scalar

Normalized reciprocal that satisfies $0.5 < |y| \leq 1$ and $2^e y = 1/u$, returned as a scalar.

- If the input at port **u** is a signed fixed-point or scaled-double data type with word length w , then **y** is a signed fixed-point or scaled-double data type with word length w and fraction length $w - 2$.
- If the input at port **u** is an unsigned fixed-point or scaled-double data type with word length w , then **y** is an unsigned fixed-point or scaled-double data type with word length w and fraction length $w - 1$.

- If the input at port **u** is a double, then **y** is a double.
- If the input at port **u** is a single, the **y** is a single.

Data Types: `single | double | fixed point`

e — Exponent

integer scalar

Exponent that satisfies $0.5 < |y| \leq 1$ and $2^e y = 1/u$, returned as an integer scalar.

Data Types: `int32`

validOut — Whether output data is valid

Boolean scalar

Whether the output data is valid, returned as a Boolean scalar. When the value of this control signal is 1 (`true`), the block has successfully computed the outputs at ports **y** and **e**. When this value is 0 (`false`), the output data is not valid.

Data Types: `Boolean`

Extended Capabilities

C/C++ Code Generation

Generate C and C++ code using Simulink® Coder™.

Slope-bias representation is not supported for fixed-point data types.

HDL Code Generation

Generate Verilog and VHDL code for FPGA and ASIC designs using HDL Coder™.

HDL Coder provides additional configuration options that affect HDL implementation and synthesized logic.

HDL Architecture

This block has a single, default HDL architecture.

HDL Block Properties

General	
ConstrainedOutputPipeline	Number of registers to place at the outputs by moving existing delays within your design. Distributed pipelining does not redistribute these registers. The default is 0. For more details, see “ConstrainedOutputPipeline” (HDL Coder).
InputPipeline	Number of input pipeline stages to insert in the generated code. Distributed pipelining and constrained output pipelining can move these registers. The default is 0. For more details, see “InputPipeline” (HDL Coder).

General	
OutputPipeline	Number of output pipeline stages to insert in the generated code. Distributed pipelining and constrained output pipelining can move these registers. The default is 0. For more details, see "OutputPipeline" (HDL Coder).

Restrictions

Supports fixed-point data types only.

Fixed-Point Conversion

Design and simulate fixed-point systems using Fixed-Point Designer™.

Slope-bias representation is not supported for fixed-point data types.

See Also**Functions**

normalizedReciprocal

Blocks

HDL Reciprocal

Introduced in R2020a

Real Burst Matrix Solve Using Q-less QR Decomposition

Compute the value of X in the equation $A'AX = B$ for real-valued matrices using Q-less QR decomposition

Library: Fixed-Point Designer HDL Support / Matrices and Linear Algebra / Linear System Solvers

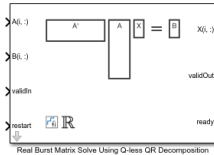

Description

The Real Burst Matrix Solve Using Q-less QR Decomposition block solves the system of linear equations $A'AX = B$ using Q-less QR decomposition, where A and B are real-valued matrices.

Ports

Input

A(i, :) — Rows of real matrix A
vector

Rows of real matrix A , specified as a vector. A is an m -by- n matrix where $m \geq 2$ and $m \geq n$. If B is single or double, A must be the same data type as B . If A is a fixed-point data type, A must be signed, use binary-point scaling, and have the same word length as B . Slope-bias representation is not supported for fixed-point data types.

Data Types: single | double | fixed point

B(i, :) — Rows of real matrix B
vector

Rows of real matrix B , specified as a vector. B is an m -by- p matrix where $m \geq 2$. If A is single or double, B must be the same data type as A . If B is a fixed-point data type, B must be signed, use binary-point scaling, and have the same word length as A . Slope-bias representation is not supported for fixed-point data types.

Data Types: single | double | fixed point

validIn — Whether inputs are valid
Boolean scalar

Whether inputs are valid, specified as a Boolean scalar. This control signal indicates when the data from the **A(i,:)** and **B(i,:)** input ports are valid. When this value is 1 (true) and the value at **ready** is 1 (true), the block captures the values at the **A(i,:)** and **B(i,:)** input ports. When this value is 0 (false), the block ignores the input samples.

After sending a `true` **validIn** signal, there may be some delay before **ready** is set to `false`. To ensure all data is processed, you must wait until **ready** is set to `false` before sending another `true` **validIn** signal.

Data Types: Boolean

restart — Whether to clear internal states

Boolean scalar

Whether to clear internal states, specified as a Boolean scalar. When this value is 1 (`true`), the block stops the current calculation and clears all internal states. When this value is 0 (`false`) and the **validIn** value is 1 (`true`), the block begins a new subframe.

Data Types: Boolean

Output

X(i, :) — Rows of matrix X

scalar | vector

Rows of the matrix X, returned as a scalar or vector.

Data Types: single | double | fixed point

validOut — Whether output data is valid

Boolean scalar

Whether the output data is valid, returned as a Boolean scalar. This control signal indicates when the data at the output port **X(i,:)** is valid. When this value is 1 (`true`), the block has successfully computed a row of X. When this value is 0 (`false`), the output data is not valid.

Data Types: Boolean

ready — Whether block is ready

Boolean scalar

Whether the block is ready, returned as a Boolean scalar. This control signal indicates when the block is ready for new input data. When this value is 1 (`true`) and the **validIn** value is 1 (`true`), the block accepts input data in the next time step. When this value is 0 (`false`), the block ignores input data in the next time step.

After sending a `true` **validIn** signal, there may be some delay before **ready** is set to `false`. To ensure all data is processed, you must wait until **ready** is set to `false` before sending another `true` **validIn** signal.

Data Types: Boolean

Parameters

Number of rows in matrix A — Number of rows in matrix A

4 (default) | positive integer-valued scalar

Number of rows in matrix A, specified as a positive integer-valued scalar.

Programmatic Use

Block Parameter: m

Type: character vector
Values: positive integer-valued scalar
Default: 4

Number of columns in matrix A and rows in matrix B — Number of columns in matrix A and rows in matrix B

4 (default) | positive integer-valued scalar

Number of columns in matrix *A* and rows in matrix *B*, specified as a positive integer-valued scalar.

Programmatic Use

Block Parameter: n
Type: character vector
Values: positive integer-valued scalar
Default: 4

Number of columns in matrix B — Number of columns in matrix B

1 (default) | positive integer-valued scalar

Number of columns in matrix *B*, specified as a positive integer-valued scalar.

Programmatic Use

Block Parameter: p
Type: character vector
Values: positive integer-valued scalar
Default: 1

Output datatype — Data type of output matrix X

fixdt(1,18,14) (default) | double | single | fixdt(1,16,0) | <data type expression>

Data type of the output matrix *X*, specified as `fixdt(1,18,14)`, `double`, `single`, `fixdt(1,16,0)`, or as a user-specified data type expression. The type can be specified directly, or expressed as a data type object such as `Simulink.NumericType`.

Programmatic Use

Block Parameter: OutputType
Type: character vector
Values: 'fixdt(1,18,14)' | 'double' | 'single' | 'fixdt(1,16,0)' | '<data type expression>'
Default: 'fixdt(1,18,14)'

Tips

Use `fixed.getQlessQRMatrixSolveModel(A,B)` to generate a template model containing a Real Burst Matrix Solve Using Q-less QR Decomposition block for real-valued input matrices *A* and *B*.

Extended Capabilities

C/C++ Code Generation

Generate C and C++ code using Simulink® Coder™.

Slope-bias representation is not supported for fixed-point data types.

HDL Code Generation

Generate Verilog and VHDL code for FPGA and ASIC designs using HDL Coder™.

HDL Coder provides additional configuration options that affect HDL implementation and synthesized logic.

HDL Architecture

This block has a single, default HDL architecture.

HDL Block Properties

General	
ConstrainedOutputPipeline	Number of registers to place at the outputs by moving existing delays within your design. Distributed pipelining does not redistribute these registers. The default is 0. For more details, see “ConstrainedOutputPipeline” (HDL Coder).
InputPipeline	Number of input pipeline stages to insert in the generated code. Distributed pipelining and constrained output pipelining can move these registers. The default is 0. For more details, see “InputPipeline” (HDL Coder).
OutputPipeline	Number of output pipeline stages to insert in the generated code. Distributed pipelining and constrained output pipelining can move these registers. The default is 0. For more details, see “OutputPipeline” (HDL Coder).

Restrictions

Supports fixed-point data types only.

Fixed-Point Conversion

Design and simulate fixed-point systems using Fixed-Point Designer™.

A and B must be signed, use binary-point scaling, and have the same word length. Slope-bias representation is not supported for fixed-point data types.

See Also

Blocks

Complex Burst Matrix Solve Using Q-less QR Decomposition | Real Burst Matrix Solve Using QR Decomposition | Real Partial-Systolic Matrix Solve Using Q-less QR Decomposition | Real Partial-Systolic Matrix Solve Using Q-less QR Decomposition with Forgetting Factor

Introduced in R2020a

Real Burst Q-less QR Decomposition

Q-less QR decomposition for real-valued matrices

Library: Fixed-Point Designer HDL Support / Matrices and Linear Algebra / Matrix Factorizations

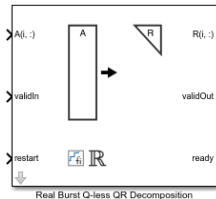

Description

The Real Burst Q-less QR Decomposition block uses QR decomposition to compute the economy size upper-triangular R factor of the QR decomposition $A = QR$, where A is a real-valued matrix, without computing Q . The solution to $A'Ax = B$ is $x = R \setminus R' \setminus b$.

Ports

Input

$A(i, :)$ — Rows of real matrix A
vector

Rows of real matrix A , specified as a vector. A is an m -by- n matrix where $m \geq 2$ and $n \geq 2$. If A is a fixed-point data type, A must be signed and use binary-point scaling. Slope-bias representation is not supported for fixed-point data types.

Data Types: `single` | `double` | `fixed point`

validIn — Whether inputs are valid

Boolean scalar

Whether inputs are valid, specified as a Boolean scalar. This control signal indicates when the data from the **$A(i, :)$** input port is valid. When this value is 1 (`true`) and the value of **ready** is 1 (`true`), the block captures the values at the **$A(i, :)$** input port. When this value is 0 (`false`), the block ignores the input samples.

After sending a `true` **validIn** signal, there may be some delay before **ready** is set to `false`. To ensure all data is processed, you must wait until **ready** is set to `false` before sending another `true` **validIn** signal.

Data Types: `Boolean`

restart — Whether to clear internal states

Boolean scalar

Whether to clear internal states, specified as a Boolean scalar. When this value is 1 (`true`), the block stops the current calculation and clears all internal states. When this value is 0 (`false`) and the value at **validIn** is 1 (`true`), the block begins a new subframe.

Data Types: Boolean

Output

R(i, :) — Rows of upper-triangular matrix *R*

scalar | vector

Rows of the economy size QR decomposition matrix *R*, returned as a scalar or vector. *R* is an upper triangular matrix. The output at **R(i,:)** has the same data type as the input at **A(i,:)**.

Data Types: single | double | fixed point

validOut — Whether output data is valid

Boolean scalar

Whether the output data is valid, specified as a Boolean scalar. This control signal indicates when the data at output port **R(i,:)** is valid. When this value is 1 (**true**), the block has successfully computed the matrix *R*. When this value is 0 (**false**), the output data is not valid.

Data Types: Boolean

ready — Whether block is ready

Boolean scalar

Whether the block is ready, returned as a Boolean scalar. This control signal indicates when the block is ready for new input data. When this value is 1 (**true**) and **validIn** is 1 (**true**), the block accepts input data in the next time step. When this value is 0 (**false**), the block ignores input data in the next time step.

After sending a **true** **validIn** signal, there may be some delay before **ready** is set to **false**. To ensure all data is processed, you must wait until **ready** is set to **false** before sending another **true** **validIn** signal.

Data Types: Boolean

Parameters

Number of rows in matrix A — Number of rows in matrix *A*

4 (default) | positive integer-valued scalar

Number of rows in input matrix *A*, specified as a positive integer-valued scalar.

Programmatic Use

Block Parameter: m

Type: character vector

Values: positive integer-valued scalar

Default: 4

Number of columns in matrix A — Number of columns in matrix *A*

4 (default) | positive integer-valued scalar

Number of columns in input matrix *A*, specified as a positive integer-valued scalar.

Programmatic Use

Block Parameter: n

Type: character vector

Values: positive integer-valued scalar

Default: 4

Tips

Use `fixed.getQlessQRDecompositionModel(A)` to generate a template model containing a Real Burst Q-less QR Decomposition block for real-valued input matrix A.

Extended Capabilities

C/C++ Code Generation

Generate C and C++ code using Simulink® Coder™.

Slope-bias representation is not supported for fixed-point data types.

HDL Code Generation

Generate Verilog and VHDL code for FPGA and ASIC designs using HDL Coder™.

HDL Coder provides additional configuration options that affect HDL implementation and synthesized logic.

HDL Architecture

This block has a single, default HDL architecture.

HDL Block Properties

General	
ConstrainedOutputPipeline	Number of registers to place at the outputs by moving existing delays within your design. Distributed pipelining does not redistribute these registers. The default is 0. For more details, see “ConstrainedOutputPipeline” (HDL Coder).
InputPipeline	Number of input pipeline stages to insert in the generated code. Distributed pipelining and constrained output pipelining can move these registers. The default is 0. For more details, see “InputPipeline” (HDL Coder).
OutputPipeline	Number of output pipeline stages to insert in the generated code. Distributed pipelining and constrained output pipelining can move these registers. The default is 0. For more details, see “OutputPipeline” (HDL Coder).

Restrictions

Supports fixed-point data types only.

Fixed-Point Conversion

Design and simulate fixed-point systems using Fixed-Point Designer™.

A must be signed and use binary-point scaling. Slope-bias representation is not supported for fixed-point data types.

See Also

Blocks

Complex Burst Q-less QR Decomposition | Real Burst QR Decomposition | Real Partial-Systolic QR Decomposition

Functions

`fixed.qlessQR`

Introduced in R2020a

Real Burst Matrix Solve Using QR Decomposition

Compute the value of x in the equation $Ax = B$ for real-valued matrices using QR decomposition

Library: Fixed-Point Designer HDL Support / Matrices and Linear Algebra / Linear System Solvers

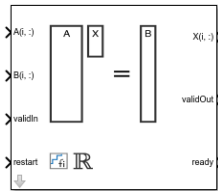

Description

The Real Burst Matrix Solve Using QR Decomposition block solves the system of linear equations $Ax = B$ using QR decomposition, where A and B are real-valued matrices. To compute $x = A^{-1}$, set B to be the identity matrix.

Ports

Input

A(i, :) — Rows of real matrix A
vector

Rows of real matrix A , specified as a vector. A is an m -by- n matrix where $m \geq 2$ and $m \geq n$. If B is single or double, A must be the same data type as B . If A is a fixed-point data type, A must be signed, use binary-point scaling, and have the same word length as B . Slope-bias representation is not supported for fixed-point data types.

Data Types: single | double | fixed point

B(i, :) — Rows of real matrix B
vector

Rows of real matrix B , specified as a vector. B is an m -by- p matrix where $m \geq 2$. If A is single or double, B must be the same data type as A . If B is a fixed-point data type, B must be signed, use binary-point scaling, and have the same word length as A . Slope-bias representation is not supported for fixed-point data types.

Data Types: single | double | fixed point

validIn — Whether inputs are valid
Boolean scalar

Whether inputs are valid, specified as a Boolean scalar. This control signal indicates when the data from the **A(i,:)** and **B(i,:)** input ports are valid. When this value is 1 (true) and the value at **ready** is 1 (true), the block captures the values on the **A(i,:)** and **B(i,:)** input ports. When this value is 0 (false), the block ignores the input samples.

After sending a `true` **validIn** signal, there may be some delay before **ready** is set to `false`. To ensure all data is processed, you must wait until **ready** is set to `false` before sending another `true` **validIn** signal.

Data Types: Boolean

restart — Whether to clear internal states

Boolean scalar

Whether to clear internal states, specified as a Boolean scalar. When this value is 1 (`true`), the block stops the current calculation and clears all internal states. When this value is 0 (`false`) and the **validIn** value is 1 (`true`), the block begins a new subframe.

Data Types: Boolean

Output

X(i, :) — Rows of matrix *X*

scalar | vector

Rows of the matrix *X*, returned as a scalar or vector.

Data Types: single | double | fixed point

validOut — Whether output data is valid

Boolean scalar

Whether the output data is valid, returned as a Boolean scalar. This control signal indicates when the data at the output port **X(i,:)** is valid. When this value is 1 (`true`), the block has successfully computed a row of matrix *X*. When this value is 0 (`false`), the output data is not valid.

Data Types: Boolean

ready — Whether block is ready

Boolean scalar

Whether the block is ready, returned as a Boolean scalar. This control signal indicates when the block is ready for new input data. When this value is 1 (`true`) and the **validIn** value is 1 (`true`), the block accepts input data in the next time step. When this value is 0 (`false`), the block ignores input data in the next time step.

After sending a `true` **validIn** signal, there may be some delay before **ready** is set to `false`. To ensure all data is processed, you must wait until **ready** is set to `false` before sending another `true` **validIn** signal.

Data Types: Boolean

Parameters

Number of rows in matrices A and B — Number of rows in matrices *A* and *B*

4 (default) | positive integer-valued scalar

Number of rows in input matrices *A* and *B*, specified as a positive integer-valued scalar.

Programmatic Use

Block Parameter: *m*

Type: character vector
Values: positive integer-valued scalar
Default: 4

Number of columns in matrix A — Number of columns in matrix A

4 (default) | positive integer-valued scalar

Number of columns in input matrix *A*, specified as a positive integer-valued scalar.

Programmatic Use

Block Parameter: n
Type: character vector
Values: positive integer-valued scalar
Default: 4

Number of columns in matrix B — Number of columns in matrix B

1 (default) | positive integer-valued scalar

Number of columns in input matrix *B*, specified as a positive integer-valued scalar.

Programmatic Use

Block Parameter: p
Type: character vector
Values: positive integer-valued scalar
Default: 1

Output datatype — Data type of the output matrix X

fixdt(1,18,14) (default) | double | single | fixdt(1,16,0) | <data type expression>

Data type of the output matrix *X*, specified as `fixdt(1,18,14)`, `double`, `single`, `fixdt(1,16,0)`, or as a user-specified data type expression. The type can be specified directly, or expressed as a data type object such as `Simulink.NumericType`.

Programmatic Use

Block Parameter: OutputType
Type: character vector
Values: 'fixdt(1,18,14)' | 'double' | 'single' | 'fixdt(1,16,0)' | '<data type expression>'
Default: 'fixdt(1,18,14)'

Tips

Use `fixed.getMatrixSolveModel(A,B)` to generate a template model containing a Real Burst Matrix Solve Using QR Decomposition block for real-valued input matrices *A* and *B*.

Extended Capabilities

C/C++ Code Generation

Generate C and C++ code using Simulink® Coder™.

Slope-bias representation is not supported for fixed-point data types.

HDL Code Generation

Generate Verilog and VHDL code for FPGA and ASIC designs using HDL Coder™.

HDL Coder provides additional configuration options that affect HDL implementation and synthesized logic.

HDL Architecture

This block has a single, default HDL architecture.

HDL Block Properties

General	
ConstrainedOutputPipeline	Number of registers to place at the outputs by moving existing delays within your design. Distributed pipelining does not redistribute these registers. The default is 0. For more details, see “ConstrainedOutputPipeline” (HDL Coder).
InputPipeline	Number of input pipeline stages to insert in the generated code. Distributed pipelining and constrained output pipelining can move these registers. The default is 0. For more details, see “InputPipeline” (HDL Coder).
OutputPipeline	Number of output pipeline stages to insert in the generated code. Distributed pipelining and constrained output pipelining can move these registers. The default is 0. For more details, see “OutputPipeline” (HDL Coder).

Restrictions

Supports fixed-point data types only.

Fixed-Point Conversion

Design and simulate fixed-point systems using Fixed-Point Designer™.

A and B must be signed, use binary-point scaling, and have the same word length. Slope-bias representation is not supported for fixed-point data types.

See Also

Blocks

Complex Burst Matrix Solve Using QR Decomposition | Real Burst Matrix Solve Using Q-less QR Decomposition | Real Partial-Systolic Matrix Solve Using QR Decomposition

Functions

fixed.qrAB

Introduced in R2019b

Real Burst QR Decomposition

QR decomposition for real-valued matrices

Library: Fixed-Point Designer HDL Support / Matrices and Linear Algebra / Matrix Factorizations

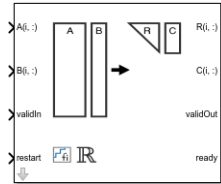

Description

The Real Burst QR Decomposition block uses QR decomposition to compute R and $C = Q'B$, where $QR = A$, and A and B are real-valued matrices. The least-squares solution to $Ax = B$ is $x = R \setminus C$. R is an upper triangular matrix and Q is an orthogonal matrix. To compute $C = Q'$, set B to be the identity matrix.

Ports

Input

A(i, :) — Rows of matrix A
vector

Rows of real matrix A , specified as a vector. A is an m -by- n matrix where $m \geq 2$ and $n \geq 2$. If B is single or double, A must be the same data type as B . If A is a fixed-point data type, A must be signed, use binary-point scaling, and have the same word length as B . Slope-bias representation is not supported for fixed-point data types.

Data Types: single | double | fixed point

B(i, :) — Rows of matrix B
vector

Rows of real matrix B , specified as a vector. B is an m -by- p matrix where $m \geq 2$. If A is single or double, B must be the same data type as A . If B is a fixed-point data type, B must be signed, use binary-point scaling, and have the same word length as A . Slope-bias representation is not supported for fixed-point data types.

Data Types: single | double | fixed point

validIn — Whether inputs are valid
Boolean scalar

Whether inputs are valid, specified as a Boolean scalar. This control signal indicates when the data from the **A(i,:)** and **B(i,:)** input ports are valid. When this value is 1 (true) and the value at **ready** is 1 (true), the block captures the values on the **A(i,:)** and **B(i,:)** input ports. When this value is 0 (false), the block ignores the input samples.

After sending a true **validIn** signal, there may be some delay before **ready** is set to false. To ensure all data is processed, you must wait until **ready** is set to false before sending another true **validIn** signal.

Data Types: Boolean

restart — Whether to clear internal states

Boolean scalar

Whether to clear internal states, specified as a Boolean scalar. When this value is 1 (true), the block stops the current calculation and clears all internal states. When this value is 0 (false) and the **validIn** value is 1 (true), the block begins a new subframe.

Data Types: Boolean

Output

R(i, :) — Rows of matrix *R*

scalar | vector

Rows of the economy size QR decomposition matrix *R*, returned as a scalar or vector. *R* is an upper triangular matrix. *R* has the same data type as *A*.

Data Types: single | double | fixed point

C(i, :) — Rows of matrix $C = Q'B$

scalar | vector

Rows of the economy size QR decomposition matrix $C=Q'B$, returned as a scalar or vector. *C* has the same number of rows as *R*. *C* has the same data type as *B*.

Data Types: single | double | fixed point

validOut — Whether output data is valid

Boolean scalar

Whether output data is valid, returned as a Boolean scalar. This control signal indicates when the data at output ports **R(i,:)** and **C(i,:)** is valid. When this value is 1 (true), the block has successfully computed the *R* and *C* matrices. When this value is 0 (false), the output data is not valid.

Data Types: Boolean

ready — Whether block is ready

Boolean scalar

Whether block is ready, returned as a Boolean scalar. This control signal that indicates when the block is ready for new input data. When this value is 1 (true) and the **validIn** value is 1 (true), the block accepts input data in the next time step. When this value is 0 (false), the block ignores input data in the next time step.

After sending a true **validIn** signal, there may be some delay before **ready** is set to false. To ensure all data is processed, you must wait until **ready** is set to false before sending another true **validIn** signal.

Data Types: Boolean

Parameters

Number of rows in matrices A and B — Number of rows in matrices A and B

4 (default) | positive integer-valued scalar

Number of rows in input matrices *A* and *B*, specified as a positive integer-valued scalar.

Programmatic Use

Block Parameter: m

Type: character vector

Values: positive integer-valued scalar

Default: 4

Number of columns in matrix A — Number of columns in matrix A

4 (default) | positive integer-valued scalar

Number of columns in input matrix *A*, specified as a positive integer-valued scalar.

Programmatic Use

Block Parameter: n

Type: character vector

Values: positive integer-valued scalar

Default: 4

Number of columns in matrix B — Number of columns in matrix B

1 (default) | positive integer-valued scalar

Number of columns in input matrix *B*, specified as a positive integer-valued scalar.

Programmatic Use

Block Parameter: p

Type: character vector

Values: positive integer-valued scalar

Default: 1

Tips

Use `fixed.getQRDecompositionModel(A,B)` to generate a template model containing a Real Burst QR Decomposition block for real-valued input matrices *A* and *B*.

Extended Capabilities

C/C++ Code Generation

Generate C and C++ code using Simulink® Coder™.

Slope-bias representation is not supported for fixed-point data types.

HDL Code Generation

Generate Verilog and VHDL code for FPGA and ASIC designs using HDL Coder™.

HDL Coder provides additional configuration options that affect HDL implementation and synthesized logic.

HDL Architecture

This block has a single, default HDL architecture.

HDL Block Properties

General	
ConstrainedOutputPipeline	Number of registers to place at the outputs by moving existing delays within your design. Distributed pipelining does not redistribute these registers. The default is 0. For more details, see “ConstrainedOutputPipeline” (HDL Coder).
InputPipeline	Number of input pipeline stages to insert in the generated code. Distributed pipelining and constrained output pipelining can move these registers. The default is 0. For more details, see “InputPipeline” (HDL Coder).
OutputPipeline	Number of output pipeline stages to insert in the generated code. Distributed pipelining and constrained output pipelining can move these registers. The default is 0. For more details, see “OutputPipeline” (HDL Coder).

Restrictions

Supports fixed-point data types only.

Fixed-Point Conversion

Design and simulate fixed-point systems using Fixed-Point Designer™.

A and B must be signed, use binary-point scaling, and have the same word length. Slope-bias representation is not supported for fixed-point data types.

See Also**Blocks**

Complex Burst QR Decomposition | Real Burst Q-less QR Decomposition | Real Partial-Systolic QR Decomposition

Functions

fixed.qrAB

Introduced in R2019b

Real Divide HDL Optimized

Divide one real input by another and generate optimized HDL code

Library: Fixed-Point Designer HDL Support / Math Operations

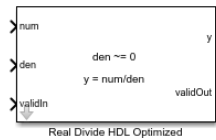

Description

The Real Divide HDL Optimized block outputs the result of dividing the real scalar **num** by the real scalar **den**, such that $y = \mathbf{num/den}$.

Limitations

Data type override is not supported for the Real Divide HDL Optimized block.

Ports

Input

num — Numerator

real scalar

Numerator, specified as a real scalar.

Data Types: `single` | `double` | `fixed point`

den — Denominator

real scalar

Denominator, specified as a real scalar.

Data Types: `single` | `double` | `fixed point`

validIn — Whether input is valid

Boolean scalar

Whether input is valid, specified as a Boolean scalar. This control signal indicates when the data from the **num** and **den** input ports are valid. When this value is 1 (`true`), the block captures the values at the input ports **num** and **den**. When this value is 0 (`false`), the block ignores the input samples.

Data Types: `Boolean`

Output

y — Output computed by dividing inputs

real scalar

Output computed by dividing **num** by **den**, such that $y = \mathbf{num/den}$, returned as a real scalar with the data type specified by the **Output datatype** parameter.

Data Types: `single` | `double` | `fixed point`

validOut — Whether output data is valid

Boolean scalar

Whether the output data is valid, returned as a Boolean scalar. When the value of this control signal is 1 (`true`), the block has successfully computed the output at port `y`. When this value is 0 (`false`), the output data is not valid.

Data Types: Boolean

Parameters

Output datatype — Data type of the output

`fixdt(1,18,10)` (default) | `single` | `fixdt(1,16,0)` | `<data type expression>`

Data type of the output `y`, specified as `fixdt(1,18,10)`, `single`, `fixdt(1,16,0)`, or as a user-specified data type expression. The type can be specified directly or expressed as a data type object, such as `Simulink.NumericType`.

Programmatic Use

Block Parameter: `OutputType`

Type: character vector

Values: `'fixdt(1,18,10)'` | `'single'` | `'fixdt(1,16,0)'` | `'<data type expression>'`

Default: `'fixdt(1,18,10)'`

Algorithms

For fixed-point inputs `num` and `den`, the Real Divide HDL Optimized block wraps on overflow for division by zero. The behavior for fixed-point division by zero is summarized in the table below.

Wrap Overflow	Saturate Overflow
$0/0 = 0$	$0/0 = 0$
$1/0 = 0$	$1/0 = \text{upper bound}$
$-1/0 = 0$	$-1/0 = \text{lower bound}$

For floating-point inputs, the Real Divide HDL Optimized block follows IEEE Standard 754.

Extended Capabilities

C/C++ Code Generation

Generate C and C++ code using Simulink® Coder™.

Slope-bias representation is not supported for fixed-point data types.

HDL Code Generation

Generate Verilog and VHDL code for FPGA and ASIC designs using HDL Coder™.

Restrictions

Supports binary-point scaled fixed-point data types only.

Fixed-Point Conversion

Design and simulate fixed-point systems using Fixed-Point Designer™.

Slope-bias representation is not supported for fixed-point data types.

See Also

Complex Divide HDL Optimized | Normalized Reciprocal HDL Optimized | Real Reciprocal HDL Optimized

Introduced in R2021a

Real Partial-Systolic Matrix Solve Using Q-less QR Decomposition

Compute value of X in $A'AX = B$ for real-valued matrices using Q-less QR decomposition

Library: Fixed-Point Designer HDL Support / Matrices and Linear Algebra / Linear System Solvers

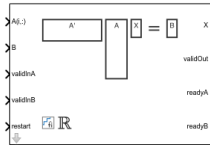

Description

The Real Partial-Systolic Matrix Solve Using Q-less QR Decomposition block solves the system of linear equations $A'AX = B$ using Q-less QR decomposition, where A and B are real-valued matrices.

Ports

Input

A(i, :) — Rows of real matrix A
vector

Rows of real matrix A , specified as a vector. A is an m -by- n matrix where $m \geq 2$ and $m \geq n$. If B is single or double, A must be the same data type as B . If A is a fixed-point data type, A must be signed, use binary-point scaling, and have the same word length as B . Slope-bias representation is not supported for fixed-point data types.

Data Types: single | double | fixed point

B — Matrix B
vector | matrix

Real matrix B , specified as a vector or matrix. B is an m -by- p matrix where $m \geq 2$. If A is single or double, B must be the same data type as A . If B is a fixed-point data type, B must be signed, use binary-point scaling, and have the same word length as A . Slope-bias representation is not supported for fixed-point data types.

Data Types: single | double | fixed point

validInA — Whether A input is valid
Boolean scalar

Whether **A(i, :)** input is valid, specified as a Boolean scalar. This control signal indicates when the data from the **A(i, :)** input port is valid. When this value is 1 (**true**) and the **readyA** value is 1 (**true**), the block captures the values at the **A(i, :)** input port. When this value is 0 (**false**), the block ignores the input samples.

After sending a **true validInA** signal, there may be some delay before **readyA** is set to **false**. To ensure all data is processed, you must wait until **readyA** is set to **false** before sending another **true validInA** signal.

Data Types: Boolean

validInB — Whether B input is valid

Boolean scalar

Whether **B** input is valid, specified as a Boolean scalar. This control signal indicates when the data from the **B** input port is valid. When this value is 1 (**true**) and the **readyB** value is 1 (**true**), the block captures the values at the **B** input port. When this value is 0 (**false**), the block ignores the input samples.

After sending a **true** **validInB** signal, there may be some delay before **readyB** is set to **false**. To ensure all data is processed, you must wait until **readyB** is set to **false** before sending another **true** **validInB** signal.

Data Types: Boolean

restart — Whether to clear internal states

Boolean scalar

Whether to clear internal states, specified as a Boolean scalar. When this value is 1 (**true**), the block stops the current calculation and clears all internal states. When this value is 0 (**false**) and the **validInA** and **validInB** values are 1 (**true**), the block begins a new subframe.

Data Types: Boolean

Output

X — Matrix X

vector | matrix

Matrix **X**, returned as a vector or matrix.

Data Types: single | double | fixed point

validOut — Whether output data is valid

Boolean scalar

Whether the output data is valid, returned as a Boolean scalar. This control signal indicates when the data at the output port **X** is valid. When this value is 1 (**true**), the block has successfully computed a row of **X**. When this value is 0 (**false**), the output data is not valid.

Data Types: Boolean

readyA — Whether block is ready for input A

Boolean scalar

Whether the block is ready for input **A(i, :)**, returned as a Boolean scalar. This control signal indicates when the block is ready for new input data. When this value is 1 (**true**) and **validInA** value is 1 (**true**), the block accepts input data in the next time step. When this value is 0 (**false**), the block ignores input data in the next time step.

After sending a **true** **validInA** signal, there may be some delay before **readyA** is set to **false**. To ensure all data is processed, you must wait until **readyA** is set to **false** before sending another **true** **validInA** signal.

Data Types: Boolean

readyB — Whether block is ready for input B

Boolean scalar

Whether the block is ready for input **B**, returned as a Boolean scalar. This control signal indicates when the block is ready for new input data. When this value is 1 (`true`) and **validInB** value is 1 (`true`), the block accepts input data in the next time step. When this value is 0 (`false`), the block ignores input data in the next time step.

After sending a `true` **validInB** signal, there may be some delay before **readyB** is set to `false`. To ensure all data is processed, you must wait until **readyB** is set to `false` before sending another `true` **validInB** signal.

Data Types: Boolean

Parameters**Number of rows in matrix A — Number of rows in matrix A**

4 (default) | positive integer-valued scalar

Number of rows in matrix *A*, specified as a positive integer-valued scalar.

Programmatic Use**Block Parameter:** *m***Type:** character vector**Values:** positive integer-valued scalar**Default:** 4**Number of columns in matrix A and rows in matrix B — Number of columns in matrix A and rows in matrix B**

4 (default) | positive integer-valued scalar

Number of columns in matrix *A* and rows in matrix *B*, specified as a positive integer-valued scalar.

Programmatic Use**Block Parameter:** *n***Type:** character vector**Values:** positive integer-valued scalar**Default:** 4**Number of columns in matrix B — Number of columns in matrix B**

1 (default) | positive integer-valued scalar

Number of columns in matrix *B*, specified as a positive integer-valued scalar.

Programmatic Use**Block Parameter:** *p***Type:** character vector**Values:** positive integer-valued scalar**Default:** 1**Output datatype — Data type of output matrix X**

fixdt(1,18,14) (default) | double | single | fixdt(1,16,0) | <data type expression>

Data type of the output matrix *X*, specified as `fixdt(1,18,14)`, `double`, `single`, `fixdt(1,16,0)`, or as a user-specified data type expression. The type can be specified directly, or expressed as a data type object such as `Simulink.NumericType`.

Programmatic Use**Block Parameter:** OutputType**Type:** character vector**Values:** 'fixdt(1,18,14)' | 'double' | 'single' | 'fixdt(1,16,0)' | '<data type expression>'**Default:** 'fixdt(1,18,14)'**Algorithms****Choosing the Implementation Method**

Partial-systolic implementations prioritize speed of computations over space constraints, while burst implementations prioritize space constraints at the expense of speed of the operations. The following table illustrates the tradeoffs between the implementations available for matrix decompositions and solving systems of linear equations.

Implementation	Ready	Latency	Area	Sample block or example
Systolic	C	$O(n)$	$O(mn^2)$	“Implement Hardware-Efficient QR Decomposition Using CORDIC in a Systolic Array”
Partial-Systolic	C	$O(m)$	$O(n^2)$	<ul style="list-style-type: none"> • Real Partial-Systolic QR Decomposition • Real Partial-Systolic Matrix Solve Using QR Decomposition
Partial-Systolic with Forgetting Factor	C	$O(n)$	$O(n^2)$	“Fixed-Point HDL-Optimized Minimum-Variance Distortionless-Response (MVDR) Beamformer”
Burst	$O(n)$	$O(mn^2)$	$O(n)$	<ul style="list-style-type: none"> • Real Burst QR Decomposition • Real Burst Matrix Solve Using QR Decomposition

Where C is a constant proportional to the word length of the data, m is the number of rows in matrix A , and n is the number of columns in matrix A .

Extended Capabilities**C/C++ Code Generation**

Generate C and C++ code using Simulink® Coder™.

Slope-bias representation is not supported for fixed-point data types.

HDL Code Generation

Generate Verilog and VHDL code for FPGA and ASIC designs using HDL Coder™.

HDL Coder provides additional configuration options that affect HDL implementation and synthesized logic.

HDL Architecture

This block has a single, default HDL architecture.

HDL Block Properties

General	
ConstrainedOutputPipeline	Number of registers to place at the outputs by moving existing delays within your design. Distributed pipelining does not redistribute these registers. The default is 0. For more details, see “ConstrainedOutputPipeline” (HDL Coder).
InputPipeline	Number of input pipeline stages to insert in the generated code. Distributed pipelining and constrained output pipelining can move these registers. The default is 0. For more details, see “InputPipeline” (HDL Coder).
OutputPipeline	Number of output pipeline stages to insert in the generated code. Distributed pipelining and constrained output pipelining can move these registers. The default is 0. For more details, see “OutputPipeline” (HDL Coder).

Restrictions

Supports fixed-point data types only.

Fixed-Point Conversion

Design and simulate fixed-point systems using Fixed-Point Designer™.

A and B must be signed, use binary-point scaling, and have the same word length. Slope-bias representation is not supported for fixed-point data types.

See Also

Blocks

Complex Partial-Systolic Q-less QR Decomposition | Real Burst Matrix Solve Using Q-less QR Decomposition | Real Partial-Systolic Matrix Solve Using Q-less QR Decomposition with Forgetting Factor | Real Partial-Systolic Matrix Solve Using QR Decomposition

Functions

`fixed.qlessQRMatrixSolve`

Introduced in R2020b

Real Partial-Systolic Matrix Solve Using Q-less QR Decomposition with Forgetting Factor

Compute value of X in $A'AX = B$ for real-valued matrices with infinite number of rows using Q-less QR decomposition

Library: Fixed-Point Designer HDL Support / Matrices and Linear Algebra / Linear System Solvers

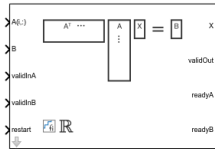

Description

The Real Partial-Systolic Matrix Solve Using Q-less QR Decomposition with Forgetting Factor block solves the system of linear equations $A'AX = B$ using Q-less QR decomposition, where A and B are real-valued matrices. A is an infinitely tall matrix representing streaming data.

Ports

Input

A(i, :) — Rows of real matrix A

vector

Rows of real matrix A , specified as a vector. A is an m -by- n matrix where $m \geq 2$ and $m \geq n$. If B is single or double, A must be the same data type as B . If A is a fixed-point data type, A must be signed, use binary-point scaling, and have the same word length as B . Slope-bias representation is not supported for fixed-point data types.

Data Types: single | double | fixed point

B — Matrix B

matrix

Real matrix B , specified as a matrix. B is an m -by- p matrix where $m \geq 2$. If A is single or double, B must be the same data type as A . If B is a fixed-point data type, B must be signed, use binary-point scaling, and have the same word length as A . Slope-bias representation is not supported for fixed-point data types.

Data Types: single | double | fixed point

validInA — Whether A input is valid

Boolean scalar

Whether **A(i, :)** input is valid, specified as a Boolean scalar. This control signal indicates when the data from the **A(i, :)** input port is valid. When this value is 1 (**true**) and the **readyA** value is 1 (**true**), the block captures the values at the **A(i, :)** input port. When this value is 0 (**false**), the block ignores the input samples.

After sending a `true` **validInA** signal, there may be some delay before **readyA** is set to `false`. To ensure all data is processed, you must wait until **readyA** is set to `false` before sending another `true` **validInA** signal.

Data Types: Boolean

validInB — Whether B input is valid

Boolean scalar

Whether **B** input is valid, specified as a Boolean scalar. This control signal indicates when the data from the **B** input port is valid. When this value is 1 (`true`) and the **readyB** value is 1 (`true`), the block captures the values at the **B** input port. When this value is 0 (`false`), the block ignores the input samples.

After sending a `true` **validInB** signal, there may be some delay before **readyB** is set to `false`. To ensure all data is processed, you must wait until **readyB** is set to `false` before sending another `true` **validInB** signal.

Data Types: Boolean

restart — Whether to clear internal states

Boolean scalar

Whether to clear internal states, specified as a Boolean scalar. When this value is 1 (`true`), the block stops the current calculation and clears all internal states. When this value is 0 (`false`) and the **validInA** and **validInB** values are both 1 (`true`), the block begins a new subframe.

Data Types: Boolean

Output

X — Matrix X

vector | matrix

Matrix *X*, returned as a vector or matrix.

Data Types: single | double | fixed point

validOut — Whether output data is valid

Boolean scalar

Whether the output data is valid, returned as a Boolean scalar. This control signal indicates when the data at the output port **X** is valid. When this value is 1 (`true`), the block has successfully computed a row of *X*. When this value is 0 (`false`), the output data is not valid.

Data Types: Boolean

readyA — Whether block is ready for input A

Boolean scalar

Whether the block is ready for input A, returned as a Boolean scalar. This control signal indicates when the block is ready for new input data. When this value is 1 (`true`) and **validInA** value is 1 (`true`), the block accepts input data in the next time step. When this value is 0 (`false`), the block ignores input data in the next time step.

After sending a `true` **validInA** signal, there may be some delay before **readyA** is set to `false`. To ensure all data is processed, you must wait until **readyA** is set to `false` before sending another `true` **validInA** signal.

Data Types: Boolean

readyB — Whether block is ready for input B

Boolean scalar

Whether the block is ready for input B, returned as a Boolean scalar. This control signal indicates when the block is ready for new input data. When this value is 1 (`true`) and **validInB** value is 1 (`true`), the block accepts input data in the next time step. When this value is 0 (`false`), the block ignores input data in the next time step.

After sending a `true` **validInB** signal, there may be some delay before **readyB** is set to `false`. To ensure all data is processed, you must wait until **readyB** is set to `false` before sending another `true` **validInB** signal.

Data Types: Boolean

Parameters

Number of columns in matrix A and rows in matrix B — Number of columns in matrix A and rows in matrix B

4 (default) | positive integer-valued scalar

Number of columns in matrix *A* and rows in matrix *B*, specified as a positive integer-valued scalar.

Programmatic Use

Block Parameter: *n*

Type: character vector

Values: positive integer-valued scalar

Default: 4

Number of columns in matrix B — Number of columns in matrix B

1 (default) | positive integer-valued scalar

Number of columns in matrix *B*, specified as a positive integer-valued scalar.

Programmatic Use

Block Parameter: *p*

Type: character vector

Values: positive integer-valued scalar

Default: 1

Forgetting factor — Forgetting factor applied after each row of matrix is factored

0.99 (default) | real positive scalar

Forgetting factor applied after each row of the matrix is factored, specified as a real positive scalar. The output is updated as each row of *A* is input indefinitely.

Programmatic Use

Block Parameter: `forgettingFactor`

Type: character vector

Values: positive integer-valued scalar

Default: 0.99

Output datatype – Data type of output matrix X

`fixdt(1,18,14)` (default) | `double` | `single` | `fixdt(1,16,0)` | `<data type expression>`

Data type of the output matrix X , specified as `fixdt(1,18,14)`, `double`, `single`, `fixdt(1,16,0)`, or as a user-specified data type expression. The type can be specified directly, or expressed as a data type object such as `Simulink.NumericType`.

Programmatic Use

Block Parameter: `OutputType`

Type: character vector

Values: `'fixdt(1,18,14)'` | `'double'` | `'single'` | `'fixdt(1,16,0)'` | `'<data type expression>'`

Default: `'fixdt(1,18,14)'`

Algorithms

Choosing the Implementation Method

Partial-systolic implementations prioritize speed of computations over space constraints, while burst implementations prioritize space constraints at the expense of speed of the operations. The following table illustrates the tradeoffs between the implementations available for matrix decompositions and solving systems of linear equations.

Implementation	Ready	Latency	Area	Sample block or example
Systolic	C	$O(n)$	$O(mn^2)$	“Implement Hardware-Efficient QR Decomposition Using CORDIC in a Systolic Array”
Partial-Systolic	C	$O(m)$	$O(n^2)$	<ul style="list-style-type: none"> Real Partial-Systolic QR Decomposition Real Partial-Systolic Matrix Solve Using QR Decomposition
Partial-Systolic with Forgetting Factor	C	$O(n)$	$O(n^2)$	“Fixed-Point HDL-Optimized Minimum-Variance Distortionless-Response (MVDR) Beamformer”

Implementation	Ready	Latency	Area	Sample block or example
Burst	$O(n)$	$O(mn^2)$	$O(n)$	<ul style="list-style-type: none"> Real Burst QR Decomposition Real Burst Matrix Solve Using QR Decomposition

Where C is a constant proportional to the word length of the data, m is the number of rows in matrix A , and n is the number of columns in matrix A .

Extended Capabilities

C/C++ Code Generation

Generate C and C++ code using Simulink® Coder™.

Slope-bias representation is not supported for fixed-point data types.

HDL Code Generation

Generate Verilog and VHDL code for FPGA and ASIC designs using HDL Coder™.

HDL Coder provides additional configuration options that affect HDL implementation and synthesized logic.

HDL Architecture

This block has a single, default HDL architecture.

HDL Block Properties

General	
ConstrainedOutputPipeline	Number of registers to place at the outputs by moving existing delays within your design. Distributed pipelining does not redistribute these registers. The default is 0. For more details, see “ConstrainedOutputPipeline” (HDL Coder).
InputPipeline	Number of input pipeline stages to insert in the generated code. Distributed pipelining and constrained output pipelining can move these registers. The default is 0. For more details, see “InputPipeline” (HDL Coder).
OutputPipeline	Number of output pipeline stages to insert in the generated code. Distributed pipelining and constrained output pipelining can move these registers. The default is 0. For more details, see “OutputPipeline” (HDL Coder).

Restrictions

Supports fixed-point data types only.

Fixed-Point Conversion

Design and simulate fixed-point systems using Fixed-Point Designer™.

A and B must be signed, use binary-point scaling, and have the same word length. Slope-bias representation is not supported for fixed-point data types.

See Also

Blocks

Complex Partial-Systolic Matrix Solve Using Q-less QR Decomposition with Forgetting Factor | Real Burst Matrix Solve Using QR Decomposition | Real Partial-Systolic Matrix Solve Using Q-less QR Decomposition | Real Partial-Systolic Matrix Solve Using QR Decomposition

Functions

`fixed.qlessQRMatrixSolve`

Introduced in R2020b

Real Partial-Systolic Matrix Solve Using QR Decomposition

Compute value of x in $Ax = B$ for real-valued matrices using QR decomposition

Library: Fixed-Point Designer HDL Support / Matrices and Linear Algebra / Linear System Solvers

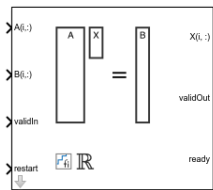

Description

The Real Partial-Systolic Matrix Solve Using QR Decomposition block solves the system of linear equations $Ax = B$ using QR decomposition, where A and B are real-valued matrices. To compute $x = A^{-1}B$, set B to be the identity matrix.

Ports

Input

A(i, :) — Rows of real matrix A

vector

Rows of real matrix A , specified as a vector. A is an m -by- n matrix where $m \geq 2$ and $m \geq n$. If B is single or double, A must be the same data type as B . If A is a fixed-point data type, A must be signed, use binary-point scaling, and have the same word length as B . Slope-bias representation is not supported for fixed-point data types.

Data Types: `single` | `double` | `fixed point`

B(i, :) — Rows of real matrix B

vector

Rows of real matrix B , specified as a vector. B is an m -by- p matrix where $m \geq 2$. If A is single or double, B must be the same data type as A . If B is a fixed-point data type, B must be signed, use binary-point scaling, and have the same word length as A . Slope-bias representation is not supported for fixed-point data types.

Data Types: `single` | `double` | `fixed point`

validIn — Whether inputs are valid

Boolean scalar

Whether inputs are valid, specified as a Boolean scalar. This control signal indicates when the data from the **A(i, :)** and **B(i, :)** input ports are valid. When this value is 1 (`true`) and the value at **ready** is 1 (`true`), the block captures the values on the **A(i, :)** and **B(i, :)** input ports. When this value is 0 (`false`), the block ignores the input samples.

After sending a `true` **validIn** signal, there may be some delay before **ready** is set to `false`. To ensure all data is processed, you must wait until **ready** is set to `false` before sending another `true` **validIn** signal.

Data Types: Boolean

restart — Whether to clear internal states

Boolean scalar

Whether to clear internal states, specified as a Boolean scalar. When this value is 1 (`true`), the block stops the current calculation and clears all internal states. When this value is 0 (`false`) and the **validIn** value is 1 (`true`), the block begins a new subframe.

Data Types: Boolean

Output

X(i, :) — Rows of matrix *X*

scalar | vector

Rows of the matrix *X*, returned as a scalar or vector.

Data Types: single | double | fixed point

validOut — Whether output data is valid

Boolean scalar

Whether the output data is valid, returned as a Boolean scalar. This control signal indicates when the data at the output port **X(i,:)** is valid. When this value is 1 (`true`), the block has successfully computed a row of matrix *X*. When this value is 0 (`false`), the output data is not valid.

Data Types: Boolean

ready — Whether block is ready

Boolean scalar

Whether the block is ready, returned as a Boolean scalar. This control signal indicates when the block is ready for new input data. When this value is 1 (`true`) and the **validIn** value is 1 (`true`), the block accepts input data in the next time step. When this value is 0 (`false`), the block ignores input data in the next time step.

After sending a `true` **validIn** signal, there may be some delay before **ready** is set to `false`. To ensure all data is processed, you must wait until **ready** is set to `false` before sending another `true` **validIn** signal.

Data Types: Boolean

Parameters

Number of rows in matrices A and B — Number of rows in matrices *A* and *B*

4 (default) | positive integer-valued scalar

Number of rows in input matrices *A* and *B*, specified as a positive integer-valued scalar.

Programmatic Use

Block Parameter: *m*

Type: character vector
Values: positive integer-valued scalar
Default: 4

Number of columns in matrix A — Number of columns in matrix A
4 (default) | positive integer-valued scalar

Number of columns in input matrix *A*, specified as a positive integer-valued scalar.

Programmatic Use
Block Parameter: n
Type: character vector
Values: positive integer-valued scalar
Default: 4

Number of columns in matrix B — Number of columns in matrix B
1 (default) | positive integer-valued scalar

Number of columns in input matrix *B*, specified as a positive integer-valued scalar.

Programmatic Use
Block Parameter: p
Type: character vector
Values: positive integer-valued scalar
Default: 1

Regularization parameter — Regularization parameter
0 (default) | real nonnegative scalar

Regularization parameter, specified as a non-negative scalar. Small, positive values of the regularization parameter can improve the conditioning of the problem and reduce the variance of the estimates. While biased, the reduced variance of the estimate often results in a smaller mean squared error when compared to least-squares estimates.

Programmatic Use
Block Parameter: k
Type: character vector
Values: real nonnegative scalar
Default: 0

Output datatype — Data type of output matrix X
fixdt(1,18,14) (default) | double | single | fixdt(1,16,0) | <data type expression>

Data type of the output matrix *X*, specified as fixdt(1,18,14), double, single, fixdt(1,16,0), or as a user-specified data type expression. The type can be specified directly, or expressed as a data type object such as Simulink.NumericType.

Programmatic Use
Block Parameter: OutputType
Type: character vector
Values: 'fixdt(1,18,14)' | 'double' | 'single' | 'fixdt(1,16,0)' | '<data type expression>'
Default: 'fixdt(1,18,14)'

Algorithms

Choosing the Implementation Method

Partial-systolic implementations prioritize speed of computations over space constraints, while burst implementations prioritize space constraints at the expense of speed of the operations. The following table illustrates the tradeoffs between the implementations available for matrix decompositions and solving systems of linear equations.

Implementation	Ready	Latency	Area	Sample block or example
Systolic	C	$O(n)$	$O(mn^2)$	“Implement Hardware-Efficient QR Decomposition Using CORDIC in a Systolic Array”
Partial-Systolic	C	$O(m)$	$O(n^2)$	<ul style="list-style-type: none"> Real Partial-Systolic QR Decomposition Real Partial-Systolic Matrix Solve Using QR Decomposition
Partial-Systolic with Forgetting Factor	C	$O(n)$	$O(n^2)$	“Fixed-Point HDL-Optimized Minimum-Variance Distortionless-Response (MVDR) Beamformer”
Burst	$O(n)$	$O(mn^2)$	$O(n)$	<ul style="list-style-type: none"> Real Burst QR Decomposition Real Burst Matrix Solve Using QR Decomposition

Where C is a constant proportional to the word length of the data, m is the number of rows in matrix A , and n is the number of columns in matrix A .

Extended Capabilities

C/C++ Code Generation

Generate C and C++ code using Simulink® Coder™.

Slope-bias representation is not supported for fixed-point data types.

HDL Code Generation

Generate Verilog and VHDL code for FPGA and ASIC designs using HDL Coder™.

HDL Coder provides additional configuration options that affect HDL implementation and synthesized logic.

HDL Architecture

This block has a single, default HDL architecture.

HDL Block Properties

General	
ConstrainedOutputPipeline	Number of registers to place at the outputs by moving existing delays within your design. Distributed pipelining does not redistribute these registers. The default is 0. For more details, see “ConstrainedOutputPipeline” (HDL Coder).
InputPipeline	Number of input pipeline stages to insert in the generated code. Distributed pipelining and constrained output pipelining can move these registers. The default is 0. For more details, see “InputPipeline” (HDL Coder).
OutputPipeline	Number of output pipeline stages to insert in the generated code. Distributed pipelining and constrained output pipelining can move these registers. The default is 0. For more details, see “OutputPipeline” (HDL Coder).

Restrictions

Supports fixed-point data types only.

Fixed-Point Conversion

Design and simulate fixed-point systems using Fixed-Point Designer™.

A and B must be signed, use binary-point scaling, and have the same word length. Slope-bias representation is not supported for fixed-point data types.

See Also**Blocks**

Complex Partial-Systolic Matrix Solve Using QR Decomposition | Real Burst Matrix Solve Using QR Decomposition | Real Partial-Systolic Matrix Solve Using Q-less QR Decomposition

Functions

`fixed.qrMatrixSolve`

Introduced in R2020b

Real Partial-Systolic Q-less QR Decomposition

Q-less QR decomposition for real-valued matrices

Library: Fixed-Point Designer HDL Support / Matrices and Linear Algebra / Matrix Factorizations

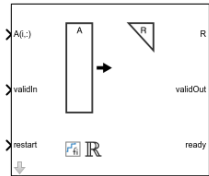

Description

The Real Partial-Systolic Q-less QR Decomposition block uses QR decomposition to compute the economy size upper-triangular R factor of the QR decomposition $A = QR$, where A is a real-valued matrix, without computing Q . The solution to $A'Ax = B$ is $x = R \setminus R' \setminus b$.

Ports

Input

A(i, :) — Rows of real matrix A
vector

Rows of real matrix A , specified as a vector. A is an m -by- n matrix where $m \geq 2$ and $n \geq 2$. If A is a fixed-point data type, A must be signed and use binary-point scaling. Slope-bias representation is not supported for fixed-point data types.

Data Types: `single` | `double` | `fixed point`

validIn — Whether inputs are valid

Boolean scalar

Whether inputs are valid, specified as a Boolean scalar. This control signal indicates when the data from the **A(i,:)** input port is valid. When this value is 1 (`true`) and the value of **ready** is 1 (`true`), the block captures the values at the **A(i,:)** input port. When this value is 0 (`false`), the block ignores the input samples.

After sending a `true` **validIn** signal, there may be some delay before **ready** is set to `false`. To ensure all data is processed, you must wait until **ready** is set to `false` before sending another `true` **validIn** signal.

Data Types: `Boolean`

restart — Whether to clear internal states

Boolean scalar

Whether to clear internal states, specified as a Boolean scalar. When this value is 1 (`true`), the block stops the current calculation and clears all internal states. When this value is 0 (`false`) and the value at **validIn** is 1 (`true`), the block begins a new subframe.

Data Types: `Boolean`

Output

R — Upper-triangular matrix *R*

matrix

Economy size QR decomposition matrix *R*, returned as a vector or matrix. *R* is an upper triangular matrix. The output at **R** has the same data type as the input at **A(i,:)**.

Data Types: `single` | `double` | `fixed point`

validOut — Whether output data is valid

Boolean scalar

Whether the output data is valid, specified as a Boolean scalar. This control signal indicates when the data at output port **R** is valid. When this value is 1 (`true`), the block has successfully computed the matrix *R*. When this value is 0 (`false`), the output data is not valid.

Data Types: `Boolean`

ready — Whether block is ready

Boolean scalar

Whether the block is ready, returned as a Boolean scalar. This control signal indicates when the block is ready for new input data. When this value is 1 (`true`) and **validIn** is 1 (`true`), the block accepts input data in the next time step. When this value is 0 (`false`), the block ignores input data in the next time step.

After sending a `true` **validIn** signal, there may be some delay before **ready** is set to `false`. To ensure all data is processed, you must wait until **ready** is set to `false` before sending another `true` **validIn** signal.

Data Types: `Boolean`

Parameters

Number of rows in matrix A — Number of rows in input matrix A

4 (default) | positive integer-valued scalar

Number of rows in input matrix *A*, specified as a positive integer-valued scalar.

Programmatic Use

Block Parameter: *m*

Type: character vector

Values: positive integer-valued scalar

Default: 4

Number of columns in matrix A — Number of columns in input matrix A

4 (default) | positive integer-valued scalar

Number of columns in input matrix *A*, specified as a positive integer-valued scalar.

Programmatic Use

Block Parameter: *n*

Type: character vector

Values: positive integer-valued scalar

Default: 4

Algorithms

Choosing the Implementation Method

Partial-systolic implementations prioritize speed of computations over space constraints, while burst implementations prioritize space constraints at the expense of speed of the operations. The following table illustrates the tradeoffs between the implementations available for matrix decompositions and solving systems of linear equations.

Implementation	Ready	Latency	Area	Sample block or example
Systolic	C	$O(n)$	$O(mn^2)$	"Implement Hardware-Efficient QR Decomposition Using CORDIC in a Systolic Array"
Partial-Systolic	C	$O(m)$	$O(n^2)$	<ul style="list-style-type: none"> Real Partial-Systolic QR Decomposition Real Partial-Systolic Matrix Solve Using QR Decomposition
Partial-Systolic with Forgetting Factor	C	$O(n)$	$O(n^2)$	"Fixed-Point HDL-Optimized Minimum-Variance Distortionless-Response (MVDR) Beamformer"
Burst	$O(n)$	$O(mn^2)$	$O(n)$	<ul style="list-style-type: none"> Real Burst QR Decomposition Real Burst Matrix Solve Using QR Decomposition

Where C is a constant proportional to the word length of the data, m is the number of rows in matrix A , and n is the number of columns in matrix A .

Block Timing

The following table provides details on the timing for the QR decomposition blocks.

Block	validIn to ready (c cycles)	validIn to validOut (v cycles)
Real Partial-Systolic QR Decomposition	$c = w + 8$	$v = c(m + n - 1)$

Block	validIn to ready (c cycles)	validIn to validOut (v cycles)
Complex Partial-Systolic QR Decomposition	$c = 2w + 15$	$v = c(m + n - 1)$
Real Partial-Systolic Q-less QR Decomposition	$c = w + 8$	$v = c(m + n - 1)$
Complex Partial-Systolic Q-less QR Decomposition	$c = 2w + 15$	$v = c(m + n - 1)$
Real Partial-Systolic Q-less QR Decomposition with Forgetting Factor	$c = w + 8$	$v = c(2n - 1)$
Complex Partial-Systolic Q-less QR Decomposition with Forgetting Factor	$c = 2w + 15$	$v = c(2n - 1)$

In the table, m represents the number of rows in matrix A , and n is the number of columns in matrix A . w represents the word length of A .

- If the data type of A is fixed point, then w is the word length.
- If the data type of A is double, then w is 53.
- If the data type of A is single, then w is 24.

Extended Capabilities

C/C++ Code Generation

Generate C and C++ code using Simulink® Coder™.

Slope-bias representation is not supported for fixed-point data types.

HDL Code Generation

Generate Verilog and VHDL code for FPGA and ASIC designs using HDL Coder™.

HDL Coder provides additional configuration options that affect HDL implementation and synthesized logic.

HDL Architecture

This block has a single, default HDL architecture.

HDL Block Properties

General	
ConstrainedOutputPipeline	Number of registers to place at the outputs by moving existing delays within your design. Distributed pipelining does not redistribute these registers. The default is 0. For more details, see “ConstrainedOutputPipeline” (HDL Coder).

General	
InputPipeline	Number of input pipeline stages to insert in the generated code. Distributed pipelining and constrained output pipelining can move these registers. The default is 0. For more details, see “InputPipeline” (HDL Coder).
OutputPipeline	Number of output pipeline stages to insert in the generated code. Distributed pipelining and constrained output pipelining can move these registers. The default is 0. For more details, see “OutputPipeline” (HDL Coder).

Restrictions

Supports fixed-point data types only.

Fixed-Point Conversion

Design and simulate fixed-point systems using Fixed-Point Designer™.

A must be signed and use binary-point scaling. Slope-bias representation is not supported for fixed-point data types.

See Also**Blocks**

Complex Partial-Systolic Q-less QR Decomposition | Real Burst Q-less QR Decomposition | Real Partial-Systolic Q-less QR Decomposition with Forgetting Factor | Real Partial-Systolic QR Decomposition

Functions

`fixed.qlessQR`

Introduced in R2020b

Real Partial-Systolic Q-less QR Decomposition with Forgetting Factor

Q-less QR decomposition for real-valued matrices with infinite number of rows

Library: Fixed-Point Designer HDL Support / Matrices and Linear Algebra / Matrix Factorizations

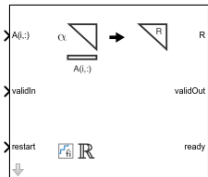

Description

The Real Partial-Systolic Q-less QR Decomposition with Forgetting Factor block uses QR decomposition to compute the economy size upper-triangular R factor of the QR decomposition $A = QR$, without computing Q . A is an infinitely tall real-valued matrix representing streaming data.

The solution to $A'Ax = B$ is $x = R \setminus R' \setminus b$.

Ports

Input

A(i,:) — Rows of real matrix A
vector

Rows of real matrix A , specified as a vector. A is an infinitely tall matrix of streaming data. If A uses a fixed-point data type, A must be signed and use binary-point scaling. Slope-bias representation is not supported for fixed-point data types.

Data Types: `single` | `double` | `fixed point`

validIn — Whether inputs are valid

Boolean scalar

Whether inputs are valid, specified as a Boolean scalar. This control signal indicates when the data from the **A(i,:)** input port is valid. When this value is 1 (`true`) and the value of **ready** is 1 (`true`), the block captures the values at the **A(i,:)** input port. When this value is 0 (`false`), the block ignores the input samples.

After sending a `true` **validIn** signal, there may be some delay before **ready** is set to `false`. To ensure all data is processed, you must wait until **ready** is set to `false` before sending another `true` **validIn** signal.

Data Types: `Boolean`

restart — Whether to clear internal states

Boolean scalar

Whether to clear internal states, specified as a Boolean scalar. When this value is 1 (`true`), the block stops the current calculation and clears all internal states. When this value is 0 (`false`) and the value at **validIn** is 1 (`true`), the block begins a new subframe.

Data Types: Boolean

Output

R — Upper-triangular matrix R

matrix

Economy size QR decomposition matrix R multiplied by the `Forgetting factor` parameter, returned as a matrix. R is an upper triangular matrix. The output at **R** has the same data type as the input at **A(i,:)**.

Data Types: single | double | fixed point

validOut — Whether output data is valid

Boolean scalar

Whether the output data is valid, specified as a Boolean scalar. This control signal indicates when the data at output port **R** is valid. When this value is 1 (`true`), the block has successfully computed the matrix R . When this value is 0 (`false`), the output data is not valid.

Data Types: Boolean

ready — Whether block is ready

Boolean scalar

Whether the block is ready, returned as a Boolean scalar. This control signal indicates when the block is ready for new input data. When this value is 1 (`true`) and **validIn** is 1 (`true`), the block accepts input data in the next time step. When this value is 0 (`false`), the block ignores input data in the next time step.

After sending a `true` **validIn** signal, there may be some delay before **ready** is set to `false`. To ensure all data is processed, you must wait until **ready** is set to `false` before sending another `true` **validIn** signal.

Data Types: Boolean

Parameters

Number of columns in matrix A — Number of columns in input matrix A

4 (default) | positive integer-valued scalar

Number of columns in input matrix A , specified as a positive integer-valued scalar.

Programmatic Use

Block Parameter: `n`

Type: character vector

Values: positive integer-valued scalar

Default: 4

Forgetting factor — Forgetting factor applied after each row of the matrix is factored

0.99 (default) | real positive scalar

Forgetting factor applied after each row of the matrix is factored, specified as a real positive scalar. The output is updated as each row of A is input indefinitely.

Programmatic Use

Block Parameter: `forgetting_factor`

Type: character vector

Values: positive integer-valued scalar

Default: 0.99

Algorithms

Choosing the Implementation Method

Partial-systolic implementations prioritize speed of computations over space constraints, while burst implementations prioritize space constraints at the expense of speed of the operations. The following table illustrates the tradeoffs between the implementations available for matrix decompositions and solving systems of linear equations.

Implementation	Ready	Latency	Area	Sample block or example
Systolic	C	$O(n)$	$O(mn^2)$	“Implement Hardware-Efficient QR Decomposition Using CORDIC in a Systolic Array”
Partial-Systolic	C	$O(m)$	$O(n^2)$	<ul style="list-style-type: none"> Real Partial-Systolic QR Decomposition Real Partial-Systolic Matrix Solve Using QR Decomposition
Partial-Systolic with Forgetting Factor	C	$O(n)$	$O(n^2)$	“Fixed-Point HDL-Optimized Minimum-Variance Distortionless-Response (MVDR) Beamformer”
Burst	$O(n)$	$O(mn^2)$	$O(n)$	<ul style="list-style-type: none"> Real Burst QR Decomposition Real Burst Matrix Solve Using QR Decomposition

Where C is a constant proportional to the word length of the data, m is the number of rows in matrix A , and n is the number of columns in matrix A .

Block Timing

The following table provides details on the timing for the QR decomposition blocks.

Block	validIn to ready (c cycles)	validIn to validOut (v cycles)
Real Partial-Systolic QR Decomposition	$c = w + 8$	$v = c(m + n - 1)$
Complex Partial-Systolic QR Decomposition	$c = 2w + 15$	$v = c(m + n - 1)$
Real Partial-Systolic Q-less QR Decomposition	$c = w + 8$	$v = c(m + n - 1)$
Complex Partial-Systolic Q-less QR Decomposition	$c = 2w + 15$	$v = c(m + n - 1)$
Real Partial-Systolic Q-less QR Decomposition with Forgetting Factor	$c = w + 8$	$v = c(2n - 1)$
Complex Partial-Systolic Q-less QR Decomposition with Forgetting Factor	$c = 2w + 15$	$v = c(2n - 1)$

In the table, m represents the number of rows in matrix A , and n is the number of columns in matrix A . w represents the word length of A .

- If the data type of A is fixed point, then w is the word length.
- If the data type of A is double, then w is 53.
- If the data type of A is single, then w is 24.

Extended Capabilities

C/C++ Code Generation

Generate C and C++ code using Simulink® Coder™.

Slope-bias representation is not supported for fixed-point data types.

HDL Code Generation

Generate Verilog and VHDL code for FPGA and ASIC designs using HDL Coder™.

HDL Coder provides additional configuration options that affect HDL implementation and synthesized logic.

HDL Architecture

This block has a single, default HDL architecture.

HDL Block Properties

General	
ConstrainedOutputPipeline	Number of registers to place at the outputs by moving existing delays within your design. Distributed pipelining does not redistribute these registers. The default is 0. For more details, see “ConstrainedOutputPipeline” (HDL Coder).

General	
InputPipeline	Number of input pipeline stages to insert in the generated code. Distributed pipelining and constrained output pipelining can move these registers. The default is 0. For more details, see “InputPipeline” (HDL Coder).
OutputPipeline	Number of output pipeline stages to insert in the generated code. Distributed pipelining and constrained output pipelining can move these registers. The default is 0. For more details, see “OutputPipeline” (HDL Coder).

Restrictions

Supports fixed-point data types only.

Fixed-Point Conversion

Design and simulate fixed-point systems using Fixed-Point Designer™.

A must be signed and use binary-point scaling. Slope-bias representation is not supported.

See Also**Blocks**

Complex Partial-Systolic Q-less QR Decomposition with Forgetting Factor | Real Burst Q-less QR Decomposition | Real Partial-Systolic Q-less QR Decomposition | Real Partial-Systolic QR Decomposition

Functions

fixed.qlessQR

Introduced in R2020b

Real Partial-Systolic QR Decomposition

QR decomposition for real-valued matrices

Library: Fixed-Point Designer HDL Support / Matrices and Linear Algebra / Matrix Factorizations

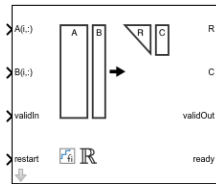

Description

The Real Partial-Systolic QR Decomposition block uses QR decomposition to compute R and $C = Q'B$, where $QR = A$, and A and B are real-valued matrices. The least-squares solution to $Ax = B$ is $x = R \setminus C$. R is an upper triangular matrix and Q is an orthogonal matrix. To compute $C = Q'$, set B to be the identity matrix.

Ports

Input

A(i, :) — Rows of matrix A
vector

Rows of real matrix A , specified as a vector. A is an m -by- n matrix where $m \geq 2$ and $n \geq 2$. If B is single or double, A must be the same data type as B . If A is a fixed-point data type, A must be signed, use binary-point scaling, and have the same word length as B . Slope-bias representation is not supported for fixed-point data types.

Data Types: `single` | `double` | `fixed point`

B(i, :) — Rows of matrix B
vector

Rows of real matrix B , specified as a vector. B is an m -by- p matrix where $m \geq 2$. If A is single or double, B must be the same data type as A . If B is a fixed-point data type, B must be signed, use binary-point scaling, and have the same word length as A . Slope-bias representation is not supported for fixed-point data types.

Data Types: `single` | `double` | `fixed point`

validIn — Whether inputs are valid
Boolean scalar

Whether inputs are valid, specified as a Boolean scalar. This control signal indicates when the data from the **A(i,:)** and **B(i,:)** input ports are valid. When this value is 1 (`true`) and the value at **ready** is 1 (`true`), the block captures the values on the **A(i,:)** and **B(i,:)** input ports. When this value is 0 (`false`), the block ignores the input samples.

After sending a true **validIn** signal, there may be some delay before **ready** is set to false. To ensure all data is processed, you must wait until **ready** is set to false before sending another true **validIn** signal.

Data Types: Boolean

restart — Whether to clear internal states

Boolean scalar

Whether to clear internal states, specified as a Boolean scalar. When this value is 1 (true), the block stops the current calculation and clears all internal states. When this value is 0 (false) and the **validIn** value is 1 (true), the block begins a new subframe.

Data Types: Boolean

Output

R — Matrix R

scalar | vector

Economy size QR decomposition matrix R , returned as a scalar or vector. R is an upper triangular matrix. R has the same data type as A .

Data Types: single | double | fixed point

C — Matrix $C = Q'B$

scalar | vector

Economy size QR decomposition matrix $C=Q'B$, returned as a scalar or vector. C has the same number of rows as R . C has the same data type as B .

Data Types: single | double | fixed point

validOut — Whether output data is valid

Boolean scalar

Whether output data is valid, returned as a Boolean scalar. This control signal indicates when the data at output ports **R** and **C** is valid. When this value is 1 (true), the block has successfully computed the R and C matrices. When this value is 0 (false), the output data is not valid.

Data Types: Boolean

ready — Whether block is ready

Boolean scalar

Whether block is ready, returned as a Boolean scalar. This control signal that indicates when the block is ready for new input data. When this value is 1 (true) and the **validIn** value is 1 (true), the block accepts input data in the next time step. When this value is 0 (false), the block ignores input data in the next time step.

After sending a true **validIn** signal, there may be some delay before **ready** is set to false. To ensure all data is processed, you must wait until **ready** is set to false before sending another true **validIn** signal.

Data Types: Boolean

Parameters

Number of rows in input matrices A and B — Number of rows in matrices A and B
4 (default) | positive integer-valued scalar

Number of rows in input matrices A and B , specified as a positive integer-valued scalar.

Programmatic Use

Block Parameter: m

Type: character vector

Values: positive integer-valued scalar

Default: 4

Number of columns in matrix A — Number of columns in input matrix A
4 (default) | positive integer-valued scalar

Number of columns in input matrix A , specified as a positive integer-valued scalar.

Programmatic Use

Block Parameter: n

Type: character vector

Values: positive integer-valued scalar

Default: 4

Number of columns in matrix B — Number of columns in input matrix B
1 (default) | positive integer-valued scalar

Number of columns in input matrix B , specified as a positive integer-valued scalar.

Programmatic Use

Block Parameter: p

Type: character vector

Values: positive integer-valued scalar

Default: 1

Regularization parameter — Regularization parameter
0 (default) | real nonnegative scalar

Regularization parameter, specified as a non-negative scalar. Small, positive values of the regularization parameter can improve the conditioning of the problem and reduce the variance of the estimates. While biased, the reduced variance of the estimate often results in a smaller mean squared error when compared to least-squares estimates.

Programmatic Use

Block Parameter: k

Type: character vector

Values: real nonnegative scalar

Default: 0

Algorithms

Choosing the Implementation Method

Partial-systolic implementations prioritize speed of computations over space constraints, while burst implementations prioritize space constraints at the expense of speed of the operations. The following

table illustrates the tradeoffs between the implementations available for matrix decompositions and solving systems of linear equations.

Implementation	Ready	Latency	Area	Sample block or example
Systolic	C	$O(n)$	$O(mn^2)$	“Implement Hardware-Efficient QR Decomposition Using CORDIC in a Systolic Array”
Partial-Systolic	C	$O(m)$	$O(n^2)$	<ul style="list-style-type: none"> Real Partial-Systolic QR Decomposition Real Partial-Systolic Matrix Solve Using QR Decomposition
Partial-Systolic with Forgetting Factor	C	$O(n)$	$O(n^2)$	“Fixed-Point HDL-Optimized Minimum-Variance Distortionless-Response (MVDR) Beamformer”
Burst	$O(n)$	$O(mn^2)$	$O(n)$	<ul style="list-style-type: none"> Real Burst QR Decomposition Real Burst Matrix Solve Using QR Decomposition

Where C is a constant proportional to the word length of the data, m is the number of rows in matrix A , and n is the number of columns in matrix A .

Block Timing

The following table provides details on the timing for the QR decomposition blocks.

Block	validIn to ready (c cycles)	validIn to validOut (v cycles)
Real Partial-Systolic QR Decomposition	$c = w + 8$	$v = c(m + n - 1)$
Complex Partial-Systolic QR Decomposition	$c = 2w + 15$	$v = c(m + n - 1)$
Real Partial-Systolic Q-less QR Decomposition	$c = w + 8$	$v = c(m + n - 1)$
Complex Partial-Systolic Q-less QR Decomposition	$c = 2w + 15$	$v = c(m + n - 1)$

Block	validIn to ready (c cycles)	validIn to validOut (v cycles)
Real Partial-Systolic Q-less QR Decomposition with Forgetting Factor	$c = w + 8$	$v = c(2n - 1)$
Complex Partial-Systolic Q-less QR Decomposition with Forgetting Factor	$c = 2w + 15$	$v = c(2n - 1)$

In the table, m represents the number of rows in matrix A , and n is the number of columns in matrix A . w represents the word length of A .

- If the data type of A is fixed point, then w is the word length.
- If the data type of A is double, then w is 53.
- If the data type of A is single, then w is 24.

Extended Capabilities

C/C++ Code Generation

Generate C and C++ code using Simulink® Coder™.

Slope-bias representation is not supported for fixed-point data types.

HDL Code Generation

Generate Verilog and VHDL code for FPGA and ASIC designs using HDL Coder™.

HDL Coder provides additional configuration options that affect HDL implementation and synthesized logic.

HDL Architecture

This block has a single, default HDL architecture.

HDL Block Properties

General	
ConstrainedOutputPipeline	Number of registers to place at the outputs by moving existing delays within your design. Distributed pipelining does not redistribute these registers. The default is 0. For more details, see “ConstrainedOutputPipeline” (HDL Coder).
InputPipeline	Number of input pipeline stages to insert in the generated code. Distributed pipelining and constrained output pipelining can move these registers. The default is 0. For more details, see “InputPipeline” (HDL Coder).

General	
OutputPipeline	Number of output pipeline stages to insert in the generated code. Distributed pipelining and constrained output pipelining can move these registers. The default is 0. For more details, see “OutputPipeline” (HDL Coder).

Restrictions

Supports fixed-point data types only.

Fixed-Point Conversion

Design and simulate fixed-point systems using Fixed-Point Designer™.

A and B must be signed, use binary-point scaling, and have the same word length. Slope-bias representation is not supported for fixed-point data types.

See Also**Blocks**

Complex Partial-Systolic QR Decomposition | Real Burst QR Decomposition | Real Partial-Systolic Q-less QR Decomposition

Functions

`fixed.qrAB`

Introduced in R2020b

Real Reciprocal HDL Optimized

Compute reciprocal and generate optimized HDL code

Library: Fixed-Point Designer HDL Support / Math Operations

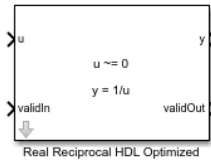

Description

The Real Reciprocal HDL Optimized block computes $1/\mathbf{u}$, where \mathbf{u} is a real scalar.

Limitations

Data type override is not supported for the Real Reciprocal HDL Optimized block.

Ports

Input

u — Value to take reciprocal of

real scalar

Value to take the reciprocal of, specified as a real scalar.

Data Types: `single` | `double` | `fixed point`

validIn — Whether input is valid

Boolean scalar

Whether input is valid, specified as a Boolean scalar. This control signal indicates when the data from the **u** input port is valid. When this value is 1 (`true`), the block captures the value at the **u** input port. When this value is 0 (`false`), the block ignores the input samples.

Data Types: `Boolean`

Output

y — Reciprocal

real scalar

Reciprocal, returned as a real scalar with the data type specified by the **Output datatype** parameter.

Data Types: `single` | `double` | `fixed point`

validOut — Whether output data is valid

Boolean scalar

Whether output data is valid, returned as a Boolean scalar. When the value of this control signal is 1 (`true`), the block has successfully computed the output at port `y`. When this value is 0 (`false`), the output data is not valid.

Data Types: `Boolean`

Parameters

Output datatype — Data type of output

`fixdt(1,18,10)` (default) | `single` | `fixdt(1,16,0)` | `<data type expression>`

Data type of the output `y`, specified as `fixdt(1,18,10)`, `single`, `fixdt(1,16,0)`, or as a user-specified data type expression. The type can be specified directly, or expressed as a data type object, such as `Simulink.NumericType`.

Programmatic Use

Block Parameter: `OutputType`

Type: character vector

Values: `'fixdt(1,18,10)'` | `'single'` | `'fixdt(1,16,0)'` | `'<data type expression>'`

Default: `'fixdt(1,18,10)'`

Algorithms

For fixed-point input `u`, the Real Reciprocal HDL Optimized block wraps on overflow for division by zero. The behavior for fixed-point division by zero is summarized in the table below.

Wrap Overflow	Saturate Overflow
$0/0 = 0$	$0/0 = 0$
$1/0 = 0$	$1/0 = \text{upper bound}$
$-1/0 = 0$	$-1/0 = \text{lower bound}$

For floating-point inputs, the Real Reciprocal HDL Optimized block follows IEEE Standard 754.

Extended Capabilities

C/C++ Code Generation

Generate C and C++ code using Simulink® Coder™.

Slope-bias representation is not supported for fixed-point data types.

HDL Code Generation

Generate Verilog and VHDL code for FPGA and ASIC designs using HDL Coder™.

Restrictions

Supports fixed-point data types only.

Fixed-Point Conversion

Design and simulate fixed-point systems using Fixed-Point Designer™.

Slope-bias representation is not supported for fixed-point data types.

See Also

Complex Divide HDL Optimized | Normalized Reciprocal HDL Optimized | Real Divide HDL Optimized

Introduced in R2021a

Properties

- “fi Object Properties” on page 3-2
- “quantizer Object Properties” on page 3-4

fi Object Properties

The properties associated with `fi` objects are described in the following sections in alphabetical order.

You can set these properties when you create a `fi` object. For example, to set the stored integer value of a `fi` object:

```
x = fi(0,true,16,15,'int',4);
```

Note The `fimath` properties and `numericType` properties are also properties of the `fi` object. Refer to “`fimath` Object Properties” and “`numericType` Object Properties” for more information.

bin

Stored integer value of a `fi` object in binary.

data

Numerical real-world value of a `fi` object.

dec

Stored integer value of a `fi` object in decimal.

double

Real-world value of a `fi` object stored as a MATLAB `double`.

fimath

`fimath` properties associated with a `fi` object. `fimath` properties determine the rules for performing fixed-point arithmetic operations on `fi` objects. `fi` objects get their `fimath` properties from a local `fimath` object or from default values. The factory-default `fimath` values have the following settings:

```
RoundingMethod: Nearest
OverflowAction: Saturate
ProductMode: FullPrecision
SumMode: FullPrecision
```

To learn more about `fimath` objects, refer to “`fimath` Object Construction”. For more information about each of the `fimath` object properties, refer to “`fimath` Object Properties”.

hex

Stored integer value of a `fi` object in hexadecimal.

int

Stored integer value of a `fi` object, stored in a built-in MATLAB integer data type.

NumericType

The `numericType` object contains all the data type and scaling attributes of a fixed-point object. The `numericType` object behaves like any MATLAB structure, except that it only lets you set valid values for defined fields. For a table of the possible settings of each field of the structure, see “Valid Values for `numericType` Object Properties” in the Fixed-Point Designer User's Guide.

Note You cannot change the `numericType` properties of a `fi` object after `fi` object creation.

oct

Stored integer value of a `fi` object in octal.

Value

Full-precision real world value of a `fi` object, stored as a character vector.

quantizer Object Properties

The properties associated with `quantizer` objects are described in the following sections in alphabetical order.

DataMode

Type of arithmetic used in quantization. This property can have the following values:

- `fixed` — Signed fixed-point calculations
- `float` — User-specified floating-point calculations
- `double` — Double-precision floating-point calculations
- `single` — Single-precision floating-point calculations
- `ufixed` — Unsigned fixed-point calculations

The default value of this property is `fixed`.

When you set the `DataMode` property value to `double` or `single`, the `Format` property value becomes read only.

Format

Data format of a `quantizer` object. The interpretation of this property value depends on the value of the `DataMode` property.

For example, whether you specify the `DataMode` property with fixed- or floating-point arithmetic affects the interpretation of the data format property. For some `DataMode` property values, the data format property is read only.

The following table shows you how to interpret the values for the `Format` property value when you specify it, or how it is specified in read-only cases.

DataMode Property Value	Interpreting the Format Property Values
<code>fixed</code> or <code>ufixed</code>	<p>You specify the <code>Format</code> property value as a vector. The number of bits for the <code>quantizer</code> object word length is the first entry of this vector, and the number of bits for the <code>quantizer</code> object fraction length is the second entry.</p> <p>The word length can range from 2 to the limits of memory on your PC. The fraction length can range from 0 to one less than the word length.</p>
<code>float</code>	<p>You specify the <code>Format</code> property value as a vector. The number of bits you want for the <code>quantizer</code> object word length is the first entry of this vector, and the number of bits you want for the <code>quantizer</code> object exponent length is the second entry.</p> <p>The word length can range from 2 to the limits of memory on your PC. The exponent length can range from 0 to 11.</p>
<code>double</code>	<p>The <code>Format</code> property value is specified automatically (is read only) when you set the <code>DataMode</code> property to <code>double</code>. The value is <code>[64 11]</code>, specifying the word length and exponent length, respectively.</p>

DataMode Property Value	Interpreting the Format Property Values
single	The Format property value is specified automatically (is read only) when you set the DataMode property to single. The value is [32 8], specifying the word length and exponent length, respectively.

OverflowMode

Overflow-handling mode. The value of the `OverflowMode` property can be one of the following:

- `Saturate` — Overflows saturate.

When the values of data to be quantized lie outside the range of the largest and smallest representable numbers (as specified by the data format properties), these values are quantized to the value of either the largest or smallest representable value, depending on which is closest.

- `Wrap` — Overflows wrap to the range of representable values.

When the values of data to be quantized lie outside the range of the largest and smallest representable numbers (as specified by the data format properties), these values are wrapped back into that range using modular arithmetic relative to the smallest representable number.

The default value of this property is `Saturate`. This property becomes a read-only property when you set the `DataMode` property to `float`, `double`, or `single`.

Note Floating-point numbers that extend beyond the dynamic range overflow to $\pm\text{inf}$.

RoundingMode

Rounding method. The value of the `RoundingMode` property can be one of the following:

- `Ceiling` — Round up to the next allowable quantized value.
- `Convergent` — Round to the nearest allowable quantized value. Numbers that are exactly halfway between the two nearest allowable quantized values are rounded up only if the least significant bit (after rounding) would be set to 0.
- `Zero` — Round negative numbers up and positive numbers down to the next allowable quantized value.
- `Floor` — Round down to the next allowable quantized value.
- `Nearest` — Round to the nearest allowable quantized value. Numbers that are halfway between the two nearest allowable quantized values are rounded up.

The default value of this property is `Floor`.

Functions

abs

Absolute value of `fi` object

Syntax

```
y = abs(a)
y = abs(a,T)
y = abs(a,F)
y = abs(a,T,F)
```

Description

`y = abs(a)` returns the absolute value of `fi` object `a` with the same `numericType` object as `a`. Intermediate quantities are calculated using the `fimath` associated with `a`. The output `fi` object, `y`, has the same local `fimath` as `a`.

`y = abs(a,T)` returns a `fi` object with a value equal to the absolute value of `a` and `numericType` object `T`. Intermediate quantities are calculated using the `fimath` associated with `a` and the output `fi` object `y` has the same local `fimath` as `a`. See “Data Type Propagation Rules” on page 4-8.

`y = abs(a,F)` returns a `fi` object with a value equal to the absolute value of `a` and the same `numericType` object as `a`. Intermediate quantities are calculated using the `fimath` object `F`. The output `fi` object, `y`, has no local `fimath`.

`y = abs(a,T,F)` returns a `fi` object with a value equal to the absolute value of `a` and the `numericType` object `T`. Intermediate quantities are calculated using the `fimath` object `F`. The output `fi` object, `y`, has no local `fimath`. See “Data Type Propagation Rules” on page 4-8.

Examples

Absolute Value of Most Negative Representable Value

This example shows the difference between the absolute value results for the most negative value representable by a signed data type when the `'OverflowAction'` property is set to `'Saturate'` or `'Wrap'`.

Calculate the absolute value when the `'OverflowAction'` is set to the default value `'Saturate'`.

```
P = fipref('NumericTypeDisplay','full',...
          'FimathDisplay','full');
a = fi(-128)
y = abs(a)

a =

    -128
```

```
DataTypeMode: Fixed-point: binary point scaling
Signedness: Signed
WordLength: 16
```

```

    FractionLength: 8

y =
    127.9961

    DataTypeMode: Fixed-point: binary point scaling
    Signedness: Signed
    WordLength: 16
    FractionLength: 8

```

abs returns 127.9961, which is a result of saturation to the maximum positive value.

Calculate the absolute value when the 'OverflowAction' is set to 'Wrap'.

```

a.OverflowAction = 'Wrap'
y = abs(a)

a =
    -128

    DataTypeMode: Fixed-point: binary point scaling
    Signedness: Signed
    WordLength: 16
    FractionLength: 8

    RoundingMethod: Nearest
    OverflowAction: Wrap
    ProductMode: FullPrecision
    SumMode: FullPrecision

y =
    -128

    DataTypeMode: Fixed-point: binary point scaling
    Signedness: Signed
    WordLength: 16
    FractionLength: 8

    RoundingMethod: Nearest
    OverflowAction: Wrap
    ProductMode: FullPrecision
    SumMode: FullPrecision

```

abs returns 128, which is a result of wrapping back to the most negative value.

Difference Between Absolute Values for Real and Complex fi Inputs

This example shows the difference between the absolute value results for complex and real fi inputs that have the most negative value representable by a signed data type when the 'OverflowAction' property is set to 'Wrap'.

Define a complex fi object.

```

re = fi(-1,1,16,15);
im = fi(0,1,16,15);
a = complex(re,im)

a =

-1.0000 + 0.0000i

        DataTypeMode: Fixed-point: binary point scaling
        Signedness: Signed
        WordLength: 16
        FractionLength: 15

```

a is complex, but numerically equal to the real part, re.

Calculate the absolute value of the complex fi object.

```

y = abs(a,re.numerictype,fimath('OverflowAction','Wrap'))

y =

1.0000

        DataTypeMode: Fixed-point: binary point scaling
        Signedness: Signed
        WordLength: 16
        FractionLength: 15

```

Calculate the absolute value of the real fi object.

```

y = abs(re,re.numerictype,fimath('OverflowAction','Wrap'))

y =

-1

        DataTypeMode: Fixed-point: binary point scaling
        Signedness: Signed
        WordLength: 16
        FractionLength: 15

```

Specify numerictype and fimath Inputs to Control the Result of abs for Real Inputs

This example shows how to specify numerictype and fimath objects as optional arguments to control the result of the abs function for real inputs. When you specify a fimath object as an argument, that fimath object is used to compute intermediate quantities, and the resulting fi object has no local fimath.

```

a = fi(-1,1,6,5,'OverflowAction','Wrap');
y = abs(a)

y =

-1

        DataTypeMode: Fixed-point: binary point scaling
        Signedness: Signed

```

```

        WordLength: 6
    FractionLength: 5

    RoundingMethod: Nearest
    OverflowAction: Wrap
    ProductMode: FullPrecision
    SumMode: FullPrecision

```

The returned output is identical to the input. This may be undesirable because the absolute value is expected to be positive.

```

F = fimath('OverflowAction','Saturate');
y = abs(a,F)

```

y =

```

    0.9688

```

```

        DataTypeMode: Fixed-point: binary point scaling
        Signedness: Signed
        WordLength: 6
    FractionLength: 5

```

The returned `fi` object is saturated to a value of 0.9688 and has the same `numericType` object as the input.

Because the output of `abs` is always expected to be positive, an unsigned `numericType` may be specified for the output.

```

T = numericType(a.numericType, 'Signed', false);
y = abs(a,T,F)

```

y =

```

    1

```

```

        DataTypeMode: Fixed-point: binary point scaling
        Signedness: Unsigned
        WordLength: 6
    FractionLength: 5

```

Specifying an unsigned `numericType` enables better precision.

Specify `numericType` and `fimath` Inputs to Control the Result of `abs` for Complex Inputs

This example shows how to specify `numericType` and `fimath` objects as optional arguments to control the result of the `abs` function for complex inputs.

Specify a `numericType` input and calculate the absolute value of `a`.

```

a = fi(-1-i,1,16,15,'OverflowAction','Wrap');
T = numericType(a.numericType,'Signed',false);
y = abs(a,T)

```

y =

```
1.4142
```

```

    DataTypeMode: Fixed-point: binary point scaling
    Signedness: Unsigned
    WordLength: 16
    FractionLength: 15

    RoundingMethod: Nearest
    OverflowAction: Wrap
    ProductMode: FullPrecision
    SumMode: FullPrecision

```

A `fi` object is returned with a value of 1.4142 and the specified unsigned `numericType`. The `fimath` used for intermediate calculation and the `fimath` of the output are the same as that of the input.

Now specify a `fimath` object different from that of `a`.

```

F = fimath('OverflowAction','Saturate','SumMode',...
    'KeepLSB','SumWordLength',a.WordLength,...
    'ProductMode','specifyprecision',...
    'ProductWordLength',a.WordLength,...
    'ProductFractionLength',a.FractionLength);
y = abs(a,T,F)

```

```
y =
```

```
1.4142
```

```

    DataTypeMode: Fixed-point: binary point scaling
    Signedness: Unsigned
    WordLength: 16
    FractionLength: 15

```

The specified `fimath` object is used for intermediate calculation. The `fimath` associated with the output is the default `fimath`.

Input Arguments

a — Input `fi` array

scalar | vector | matrix | multidimensional array

Input `fi` array, specified as a scalar, vector, matrix, or multidimensional array.

`abs` only supports `fi` objects with trivial [Slope Bias] scaling, that is, when the bias is 0 and the fractional slope is 1.

`abs` uses a different algorithm for real and complex inputs. For more information, see “Absolute Value” on page 4-7.

Data Types: `fi`

Complex Number Support: Yes

T — `numericType` of the output

`numericType` object

numeric type of the output `fi` object `y`, specified as a `numeric type` object. For more information, see “Data Type Propagation Rules” on page 4-8.

Example: `T = numericType(0,24,12,'DataType','Fixed')`

F — Fixed-point math settings to use

`fimath` object

Fixed-point math settings to use for the calculation of absolute value, specified as a `fimath` object.

Example: `F = fimath('OverflowAction','Saturate','RoundingMethod','Convergent')`

Algorithms

Absolute Value

The absolute value of a real number is the corresponding nonnegative value that disregards the sign.

For a real input, `a`, the absolute value, `y`, is:

$$y = a \text{ if } a \geq 0 \quad (4-1)$$

$$y = -a \text{ if } a < 0 \quad (4-2)$$

`abs(-0)` returns 0.

Note When the `fi` object `a` is real and has a signed data type, the absolute value of the most negative value is problematic since it is not representable. In this case, the absolute value saturates to the most positive value representable by the data type if the `'OverflowAction'` property is set to `'Saturate'`. If `'OverflowAction'` is `'Wrap'`, the absolute value of the most negative value has no effect.

For a complex input, `a`, the absolute value, `y`, is related to its real and imaginary parts as follows:

$$y = \sqrt{\text{real}(a)*\text{real}(a) + \text{imag}(a)*\text{imag}(a)} \quad (4-3)$$

The `abs` function computes the absolute value of a complex input, `a`, as follows:

- 1 Calculate the real and imaginary parts of `a`.

$$\text{re} = \text{real}(a) \quad (4-4)$$

$$\text{im} = \text{imag}(a) \quad (4-5)$$

- 2 Compute the squares of `re` and `im` using one of the following objects:

- The `fimath` object `F` if `F` is specified as an argument.
- The `fimath` associated with `a` if `F` is not specified as an argument.

- 3 If the input is signed, cast the squares of `re` and `im` to unsigned types.

- 4 Add the squares of `re` and `im` using one of the following objects:

- The `fimath` object `F` if `F` is specified as an argument.
- The `fimath` object associated with `a` if `F` is not specified as an argument.

- 5 Compute the square root of the sum computed in Step 4 using the `sqrt` function with the following additional arguments:
- The `numericType` object `T` if `T` is specified, or the `numericType` object of `a` otherwise.
 - The `fimath` object `F` if `F` is specified, or the `fimath` object associated with `a` otherwise.

Note Step 3 prevents the sum of the squares of the real and imaginary components from being negative. This is important because if either `re` or `im` has the maximum negative value and the `'OverflowAction'` property is set to `'Wrap'` then an error will occur when taking the square root in Step 5.

Data Type Propagation Rules

For syntaxes for which you specify a `numericType` object `T`, the `abs` function follows the data type propagation rules listed in the following table. In general, these rules can be summarized as “floating-point data types are propagated.” This allows you to write code that can be used with both fixed-point and floating-point inputs.

Data Type of Input <code>fi</code> Object <code>a</code>	Data Type of <code>numericType</code> object <code>T</code>	Data Type of Output <code>y</code>
<code>fi Fixed</code>	<code>fi Fixed</code>	Data type of <code>numericType</code> object <code>T</code>
<code>fi ScaledDouble</code>	<code>fi Fixed</code>	<code>ScaledDouble</code> with properties of <code>numericType</code> object <code>T</code>
<code>fi double</code>	<code>fi Fixed</code>	<code>fi double</code>
<code>fi single</code>	<code>fi Fixed</code>	<code>fi single</code>
Any <code>fi</code> data type	<code>fi double</code>	<code>fi double</code>
Any <code>fi</code> data type	<code>fi single</code>	<code>fi single</code>

Note When the Signedness of the input `numericType` object `T` is `Auto`, the `abs` function always returns an `Unsigned fi` object.

Extended Capabilities

C/C++ Code Generation

Generate C and C++ code using MATLAB® Coder™.

HDL Code Generation

Generate Verilog and VHDL code for FPGA and ASIC designs using HDL Coder™.

Double and complex data types are not supported.

See Also

`fi` | `fimath` | `numericType`

Introduced before R2006a

accumneg

Subtract two `fi` objects or values

Syntax

```
c = accumneg(a,b)
c = accumneg(a,b,RoundingMethod)
c = accumneg(a,b,RoundingMethod,OverflowAction)
```

Description

`c = accumneg(a,b)` subtracts `b` from `a` using the data type of `a`. `b` is cast into the data type of `a`. If `a` is a `fi` object, the default 'Floor' rounding method and default 'Wrap' overflow action are used. The `fi`math properties of `a` and `b` are ignored.

`c = accumneg(a,b,RoundingMethod)` subtracts `b` from `a` using the rounding method specified by `RoundingMethod` if `a` is a `fi` object.

`c = accumneg(a,b,RoundingMethod,OverflowAction)` subtracts `b` from `a` using the rounding method specified by `RoundingMethod` and the overflow action specified by `OverflowAction` if `a` is a `fi` object.

Examples

Subtract Two `fi` Objects or Values

This example shows how to subtract two `fi` numbers using `accumneg`.

Subtract two `fi` numbers

Subtract `b` from `a`, where `a` and `b` are both `fi` numbers, using the default rounding method of 'Floor' and overflow action of 'Wrap'.

```
a = fi(pi,1,16,13);
b = fi(1.5,1,16,14);
subtr_default = accumneg(a,b)
```

```
subtr_default =
    1.6416
```

```
        DataTypeMode: Fixed-point: binary point scaling
        Signedness: Signed
        WordLength: 16
        FractionLength: 13
```

Subtract two `fi` numbers using specified rounding and overflow action

Subtract `b` from `a`, where `a` and `b` are both `fi` numbers, using specified rounding method of 'Nearest' and overflow action of 'Saturate'.

```
a = fi(pi,1,16,13);
b = fi(1.5,1,16,14);
subtr_custom = accumneg(a,b,'Nearest','Saturate')

subtr_custom =
    1.6416

    DataTypeMode: Fixed-point: binary point scaling
    Signedness: Signed
    WordLength: 16
    FractionLength: 13
```

Input Arguments

a — Number to subtract from

fi object (default) | double | single | logical | integer

Number from which to subtract. The data type of **a** is used to compute the output data type.

Data Types: single | double | int8 | int16 | int32 | int64 | uint8 | uint16 | uint32 | uint64 | logical | fi

b — Number to subtract

fi object (default) | double | single | logical | integer

Number to subtract.

Data Types: single | double | int8 | int16 | int32 | int64 | uint8 | uint16 | uint32 | uint64 | logical | fi

RoundingMethod — Rounding method to use

'Floor' (default) | 'Ceiling' | 'Convergent' | 'Nearest' | 'Round' | 'Zero'

Rounding method to use if **a** is a fi object.

Example: `c = accumneg(a,b,'Ceiling')`

Data Types: string

OverflowAction — Overflow action to take

'Wrap' (default) | 'Saturate'

Overflow action to take if **a** is a fi object.

Example: `c = accumneg(a,b,'Ceiling','Saturate')`

Data Types: string

Output Arguments

c — Difference of inputs

fi object | double | single | logical | integer

Result of subtracting input **b** from input **a**.

Extended Capabilities

C/C++ Code Generation

Generate C and C++ code using MATLAB® Coder™.

GPU Code Generation

Generate CUDA® code for NVIDIA® GPUs using GPU Coder™.

See Also

accumpos

Topics

“Avoid Multiword Operations in Generated Code”

Introduced in R2012a

accumpos

Add two `fi` objects or values

Syntax

```
c = accumpos(a,b)
c = accumpos(a,b,RoundingMethod)
c = accumpos(a,b,RoundingMethod,OverflowAction)
```

Description

`c = accumpos(a,b)` adds `a` and `b` using the data type of `a`. `b` is cast into the data type of `a`. If `a` is a `fi` object, the default 'Floor' rounding method and default 'Wrap' overflow action are used. The `fimath` properties of `a` and `b` are ignored.

`c = accumpos(a,b,RoundingMethod)` adds `a` and `b` using the rounding method specified by `RoundingMethod`.

`c = accumpos(a,b,RoundingMethod,OverflowAction)` adds `a` and `b` using the rounding method specified by `RoundingMethod` and the overflow action specified by `OverflowAction`.

Examples

Add Two `fi` Objects or Values

This example shows how to add two `fi` numbers using `accumpos`.

Add two `fi` numbers

Add `a` and `b`, where `a` and `b` are both `fi` numbers, using the default rounding method of 'Floor' and overflow action of 'Wrap'.

```
a = fi(pi,1,16,13);
b = fi(1.5,1,16,14);
add_default = accumpos(a,b)
```

```
add_default =
    -3.3584
```

```
        DataTypeMode: Fixed-point: binary point scaling
        Signedness: Signed
        WordLength: 16
        FractionLength: 13
```

Add two `fi` numbers using specified rounding and overflow action

Add `a` and `b`, where `a` and `b` are both `fi` numbers, using specified rounding method of 'Nearest' and overflow action of 'Saturate'.

```

a = fi(pi,1,16,13);
b = fi(1.5,1,16,14);
add_custom = accumpos(a,b, 'Nearest', 'Saturate')

add_custom =
    3.9999

    DataTypeMode: Fixed-point: binary point scaling
    Signedness: Signed
    WordLength: 16
    FractionLength: 13

```

Input Arguments

a — Number to add

fi object (default) | double | single | logical | integer

Number to add. The data type of **a** is used to compute the output data type.

Data Types: single | double | int8 | int16 | int32 | int64 | uint8 | uint16 | uint32 | uint64 | logical | fi

b — Number to add

fi object (default) | double | single | logical | integer

Number to add.

Data Types: single | double | int8 | int16 | int32 | int64 | uint8 | uint16 | uint32 | uint64 | logical | fi

RoundingMethod — Rounding method to use

'Floor' (default) | 'Ceiling' | 'Convergent' | 'Nearest' | 'Round' | 'Zero'

Rounding method to use if **a** is a fi object.

Example: `c = accumpos(a,b,'Ceiling')`

Data Types: string

OverflowAction — Overflow action to take

'Wrap' (default) | 'Saturate'

Overflow action to take if **a** is a fi object.

Example: `c = accumpos(a,b,'Ceiling','Saturate')`

Data Types: string

Output Arguments

c — Sum of inputs

fi object | double | single | logical | integer

Result of adding input **a** and input **b**.

Extended Capabilities

C/C++ Code Generation

Generate C and C++ code using MATLAB® Coder™.

GPU Code Generation

Generate CUDA® code for NVIDIA® GPUs using GPU Coder™.

See Also

accumneg

Topics

“Avoid Multiword Operations in Generated Code”

Introduced in R2012a

add

Add two `fi` objects using `fimath` object

Syntax

```
c = add(F,a,b)
```

Description

`c = add(F,a,b)` adds `fi` objects `a` and `b` using `fimath` object `F`. This is helpful in cases when you want to override the `fimath` objects of `a` and `b`, or if the `fimath` properties associated with `a` and `b` are different. The output of `fi` object `c` has no local `fimath`.

Examples

Add Two Fixed-Point Numbers

In this example, `c` is the 32-bit sum of `a` and `b` with a fraction length of 16.

```
a = fi(pi);
b = fi(exp(1));
F = fimath('SumMode','SpecifyPrecision',...
    'SumWordLength',32,'SumFractionLength',16);
c = add(F,a,b)

c =

    5.8599

    DataTypeMode: Fixed-point: binary point scaling
    Signedness: Signed
    WordLength: 32
    FractionLength: 16
```

Input Arguments

F — fimath

`fimath` object

`fimath` object to use for addition.

a,b — Operands

scalars | vectors | matrices | multidimensional arrays

Operands, specified as scalars, vectors, matrices, or multidimensional arrays.

`a` and `b` must both be `fi` objects and must have the same dimensions unless one is a scalar. If either `a` or `b` is scalar, then `c` has the dimensions of the nonscalar object.

Data Types: `fi`

Complex Number Support: Yes

Algorithms

```
c = add(F,a,b)
```

is similar to

```
a.fimath = F;  
b.fimath = F;  
c = a + b
```

but not identical. When you use `add`, the `fimath` properties of `a` and `b` are not modified, and the output `fi` object, `c`, has no local `fimath`. When you use the syntax `c = a + b`, where `a` and `b` have their own `fimath` objects, the output `fi` object, `c`, gets assigned the same `fimath` object as inputs `a` and `b`.

Extended Capabilities

C/C++ Code Generation

Generate C and C++ code using MATLAB® Coder™.

Usage notes and limitations:

- The syntax `F.add(a,b)` is not supported. You must use the syntax `add(F,a,b)`.

HDL Code Generation

Generate Verilog and VHDL code for FPGA and ASIC designs using HDL Coder™.

See Also

`divide` | `fi` | `fimath` | `mpy` | `mrdivide` | `numerictype` | `rdivide` | `sub` | `sum`

Topics

“`fimath` Rules for Fixed-Point Arithmetic”

Introduced before R2006a

assignmentquantizer

Assignment quantizer object of `fi` object

Syntax

```
q = assignmentquantizer(a)
```

Description

`q = assignmentquantizer(a)` returns the quantizer object `q` that is used in assignment operations for the `fi` object `a`.

See Also

`quantize` | `quantizer`

Introduced in R2008a

atan2

Four-quadrant inverse tangent of fixed-point values

Syntax

```
z = atan2(y,x)
```

Description

`z = atan2(y,x)` returns the four-quadrant arctangent of `fi` inputs `y` and `x`.

Examples

Calculate Arctangent of Fixed-Point Input Values

Use the `atan2` function to calculate the arctangent of unsigned and signed fixed-point input values.

Unsigned Input Values

This example uses unsigned, 16-bit word length values.

```
y = fi(0.125,0,16);  
x = fi(0.5,0,16);  
z = atan2(y,x)
```

```
z =  
    0.2450
```

```
        DataTypeMode: Fixed-point: binary point scaling  
        Signedness: Unsigned  
        WordLength: 16  
        FractionLength: 15
```

Signed Input Values

This example uses signed, 16-bit word length values.

```
y = fi(-0.1,1,16);  
x = fi(-0.9,1,16);  
z = atan2(y,x)
```

```
z =  
   -3.0309
```

```
        DataTypeMode: Fixed-point: binary point scaling  
        Signedness: Signed
```

WordLength: 16
FractionLength: 13

Input Arguments

y — y-coordinates

scalar | vector | matrix | multidimensional array

y-coordinates, specified as a scalar, vector, matrix, or multidimensional array.

y and x can be real-valued, signed or unsigned scalars, vectors, matrices, or N-dimensional arrays containing fixed-point angle values in radians. The inputs y and x must be the same size. If they are not the same size, at least one input must be a scalar value. Valid data types of y and x are:

- fi single
- fi double
- fi fixed-point with binary point scaling
- fi scaled double with binary point scaling

Data Types: fi

x — x-coordinates

scalar | vector | matrix | multidimensional array

x-coordinates, specified as a scalar, vector, matrix, or multidimensional array.

y and x can be real-valued, signed or unsigned scalars, vectors, matrices, or N-dimensional arrays containing fixed-point angle values in radians. The inputs y and x must be the same size. If they are not the same size, at least one input must be a scalar value. Valid data types of y and x are:

- fi single
- fi double
- fi fixed-point with binary point scaling
- fi scaled double with binary point scaling

Data Types: fi

Output Arguments

z — Four-quadrant arctangent

scalar | vector | matrix | multidimensional array

Four-quadrant arctangent, returned as a scalar, vector, matrix, or multidimensional array.

z is the four-quadrant arctangent of y and x. The `numericType` of z depends on the signedness of y and x:

- If either y or x is signed, then z is a signed, fixed-point number in the range $[-\pi, \pi]$. It has a 16-bit word length and 13-bit fraction length (`numericType(1, 16, 13)`).
- If both y and x are unsigned, then z is an unsigned, fixed-point number in the range $[0, \pi/2]$. It has a 16-bit word length and 15-bit fraction length (`numericType(0, 16, 15)`).

The output, z , is always associated with the default `fimath`.

More About

Four-Quadrant Arctangent

The four-quadrant arctangent is defined as follows, with respect to the `atan` function:

$$\text{atan2}(y, x) = \begin{cases} \text{atan}\left(\frac{y}{x}\right) & x > 0 \\ \pi + \text{atan}\left(\frac{y}{x}\right) & y \geq 0, x < 0 \\ -\pi + \text{atan}\left(\frac{y}{x}\right) & y < 0, x < 0 \\ \frac{\pi}{2} & y > 0, x = 0 \\ -\frac{\pi}{2} & y < 0, x = 0 \\ 0 & y = 0, x = 0 \end{cases}$$

Algorithms

The `atan2` function computes the four-quadrant arctangent of fixed-point inputs using an 8-bit lookup table as follows:

- 1 Divide the input absolute values to get an unsigned, fractional, fixed-point, 16-bit ratio between 0 and 1. The absolute values of y and x determine which value is the divisor.

The signs of the y and x inputs determine in what quadrant their ratio lies. The input with the larger absolute value is used as the denominator, thus producing a value between 0 and 1.

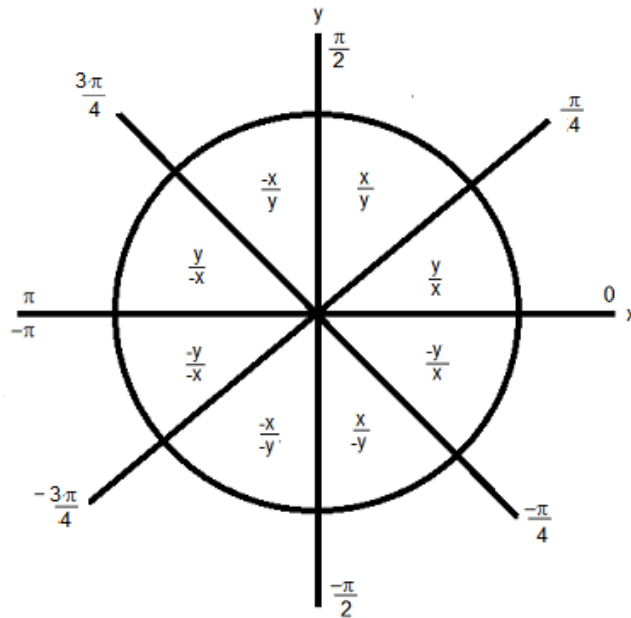

- 2 Compute the table index, based on the 16-bit, unsigned, stored integer value:
 - a Use the 8 most-significant bits to obtain the first value from the table.
 - b Use the next-greater table value as the second value.
- 3 Use the 8 least-significant bits to interpolate between the first and second values using nearest neighbor linear interpolation. This interpolation produces a value in the range $[0, \pi/4)$.
- 4 Perform octant correction on the resulting angle, based on the values of the original y and x inputs.

This arctangent calculation is accurate only to within the top 16 most-significant bits of the input.

fimath Propagation Rules

The `atan2` function ignores and discards any `fimath` attached to the inputs. The output, z , is always associated with the default `fimath`.

Extended Capabilities

C/C++ Code Generation

Generate C and C++ code using MATLAB® Coder™.

See Also

`angle` | `atan2` | `cordicatan2` | `cos` | `sin`

Topics

“Calculate Fixed-Point Arctangent”

Introduced in R2012a

autofixexp

Automatically change scaling of fixed-point data types

Syntax

autofixexp

Description

The `autofixexp` script automatically changes the scaling for model objects that specify fixed-point data types. However, if an object's **Lock output data type setting against changes by the fixed-point tools** parameter is selected, the script refrains from scaling that object.

This script collects range data for model objects, either from design minimum and maximum values that objects specify explicitly, or from logged minimum and maximum values that occur during simulation. Based on these values, the tool changes the scaling of fixed-point data types in a model so as to maximize precision and cover the range.

You can specify design minimum and maximum values for model objects using parameters typically titled **Output minimum** and **Output maximum**. See “Blocks That Allow Signal Range Specification” for a list of Simulink blocks that permit you to specify these values. In the autoscaling procedure that the `autofixexp` script executes, design minimum and maximum values take precedence over the simulation range.

If you intend to scale fixed-point data types using simulation minimum and maximum values, the script yields meaningful results when exercising the full range of values over which your design is meant to run. Therefore, the simulation you run prior to using `autofixexp` must simulate your design over its full intended operating range. It is especially important that you use simulation inputs with appropriate speed and amplitude profiles for dynamic systems. The response of a linear dynamic system is frequency dependent. For example, a bandpass filter will show almost no response to very slow and very fast sinusoid inputs, whereas the signal of a sinusoid input with a frequency in the passband will be passed or even significantly amplified. The response of nonlinear dynamic systems can have complicated dependence on both the signal speed and amplitude.

Note If you already know the simulation range you need to cover, you can use an alternate autoscaling technique described in the `fixptbestprec` reference page.

To control the parameters associated with automatic scaling, such as safety margins, use the Fixed-Point Tool.

To learn how to use the Fixed-Point Tool, refer to “Propose Fraction Lengths Using Simulation Range Data”.

See Also

`fxptdlg`

Introduced before R2006a

bin

Unsigned binary representation of stored integer of `fi` object

Syntax

```
b = bin(a)
```

Description

`b = bin(a)` returns the stored integer of `fi` object `a` in unsigned binary format as a character vector.

Fixed-point numbers can be represented as

$$\text{real-worldvalue} = 2^{-\text{fractionlength}} \times \text{storedinteger}$$

or, equivalently as

$$\text{real-worldvalue} = (\text{slope} \times \text{storedinteger}) + \text{bias}$$

The stored integer is the raw binary number, in which the binary point is assumed to be at the far right of the word.

Examples

View Stored Integer of `fi` Object in Unsigned Binary Format

Create a signed `fi` object with values `-1` and `1`, a word length of 8 bits, and a fraction length of 7 bits.

```
a = fi([-1 1], 1, 8, 7)
```

```
a=1x2 object
```

```
-1.0000    0.9922
```

```
DataTypeMode: Fixed-point: binary point scaling
Signedness: Signed
WordLength: 8
FractionLength: 7
```

Find the unsigned binary representation of the stored integers of `fi` object `a`.

```
b = bin(a)
```

```
b =
```

```
'10000000    01111111'
```

Input Arguments

a — **fi object to view in binary**

fi object

Input fi object to view in binary.

Data Types: fi

See Also

dec | hex | oct | storedInteger

Introduced before R2006a

bin2num

Convert two's complement binary string to number using `quantizer` object

Syntax

```
y = bin2num(q,b)
```

Description

`y = bin2num(q,b)` converts the binary character vector `b` to a numeric array `y` using the properties of the `quantizer` object `q`.

If `b` is a cell array containing binary strings, then `y` will be a cell array of the same dimension containing numeric arrays.

`[y1,y2,...] = bin2num(q,b1,b2,...)` converts the binary character vectors `b1`, `b2`, ... to numeric arrays `y1`, `y2`,

Examples

Convert Between Binary String and Numeric Array

Convert between a binary character vector and a numeric array using the properties specified in a `quantizer` object.

Convert Numeric Array to Binary String

Create a `quantizer` object specifying a word length of 4 bits and a fraction length of 3 bits. The other properties of the `quantizer` object take the default values of specifying a signed, fixed-point data type, rounding towards negative infinity, and saturate on overflow.

```
q = quantizer([4 3])
```

```
q =
```

```
    DataMode = fixed  
    RoundMode = floor  
    OverflowMode = saturate  
    Format = [4 3]
```

Create an array of numeric values.

```
[a,b] = range(q);  
x = (b:-eps(q):a)
```

```
x = 1×16
```

```
    0.8750    0.7500    0.6250    0.5000    0.3750    0.2500    0.1250         0   -0.1250   -0.2500
```

Convert the numeric vector x to binary representation using the properties specified by the quantizer object q . Note that `num2bin` always returns the binary representations in a column.

```
b = num2bin(q,x)
```

```
b = 16x4 char array
'0111'
'0110'
'0101'
'0100'
'0011'
'0010'
'0001'
'0000'
'1111'
'1110'
'1101'
'1100'
'1011'
'1010'
'1001'
'1000'
```

Use `bin2num` to perform the inverse operation.

```
y = bin2num(q,b)
```

```
y = 16x1
0.8750
0.7500
0.6250
0.5000
0.3750
0.2500
0.1250
0
-0.1250
-0.2500
⋮
```

Convert Binary String to Numeric Array

All of the 3-bit fixed-point two's-complement numbers in fractional form are given by:

```
q = quantizer([3 2]);
b = ['011 111'
     '010 110'
     '001 101'
     '000 100'];
```

Use `bin2num` to view the numeric equivalents of these values.

```
x = bin2num(q,b)
x = 4x2
```

```
0.7500  -0.2500
0.5000  -0.5000
0.2500  -0.7500
0        -1.0000
```

Input Arguments

q — Data type properties to use for conversion

quantizer object

Data type properties to use for conversion, specified as a `quantizer` object.

Example: `q = quantizer([16 15]);`

b — Binary string to convert

character vector | character array | cell array

Binary string to convert, specified as a character vector, character array, or cell array containing binary strings.

Data Types: `string` | `char` | `cell`

Tips

- `bin2num` and `num2bin` are inverses of one another. Note that `num2bin` always returns the binary representations in a column.

Algorithms

- The fixed-point binary representation is two's complement.
- The floating-point binary representation is in IEEE Standard 754 style.
- If there are fewer binary digits than are necessary to represent the number, then fixed-point zero-pads on the left, and floating-point zero-pads on the right.

See Also

`hex2num` | `num2bin` | `num2hex` | `num2int` | `quantizer`

Introduced before R2006a

bitand

Bitwise AND of two `fi` objects

Syntax

```
c = bitand(a,b)
```

Description

`c = bitand(a,b)` returns the bitwise AND of `fi` objects `a` and `b` in `fi` object `c`.

The `numericType` properties associated with `a` and `b` must be identical. If both inputs have a local `fi` object, the `fi` objects must be identical. If the `numericType` is signed, then the bit representation of the stored integer is in two's complement representation.

`a` and `b` must have the same dimensions unless one is a scalar.

`bitand` only supports `fi` objects with fixed-point data types.

Examples

Compute Bitwise AND of Two `fi` Objects

Create a truth table for the logical AND operation.

```
A = fi([0 1; 0 1]);
B = fi([0 0; 1 1]);
TTable = bitand(A, B)
```

```
TTable =
```

```
    0    0
    0    1
```

```
      DataTypeMode: Fixed-point: binary point scaling
      Signedness: Signed
      WordLength: 16
      FractionLength: 14
```

`bitand` returns 1 only if both bit-wise inputs are 1.

Input Arguments

a, b — Input values

scalars | vectors | matrices | multidimensional arrays

Input values, specified as scalars, vectors, matrices, or multidimensional arrays. `a` and `b` must have the same dimensions unless one is a scalar. Inputs `a` and `b` must be `fi` objects with fixed-point data types and identical `numericType` properties. If both inputs have a local `fi` object, the `fi` objects must be identical.

Data Types: `fi`

Extended Capabilities

C/C++ Code Generation

Generate C and C++ code using MATLAB® Coder™.

Usage notes and limitations:

- Slope-bias scaled `fi` objects are not supported.

HDL Code Generation

Generate Verilog and VHDL code for FPGA and ASIC designs using HDL Coder™.

See Also

`bitcmp` | `bitget` | `bitor` | `bitset` | `bitxor`

Introduced before R2006a

bitandreduce

Reduce consecutive slice of bits to one bit by performing bitwise AND operation

Syntax

```
c = bitandreduce(a)
c = bitandreduce(a, lidx)
c = bitandreduce(a, lidx, ridx)
```

Description

`c = bitandreduce(a)` performs a bitwise AND operation on the entire set of bits in the fixed-point input, `a`, and returns the result as an unsigned integer of word length 1.

`c = bitandreduce(a, lidx)` performs a bitwise AND operation on a consecutive range of bits, starting at position `lidx` and ending at the LSB (the bit at position 1).

`c = bitandreduce(a, lidx, ridx)` performs a bitwise AND operation on a consecutive range of bits, starting at position `lidx` and ending at position `ridx`.

The `bitandreduce` arguments must satisfy the following condition:

```
a.WordLength >= lidx >= ridx >= 1
```

Examples

Perform Bitwise AND Operation on an Entire Set of Bits

Create a fixed-point number.

```
a = fi(73,0,8,0);
disp(bin(a))
```

```
01001001
```

Perform a bitwise AND operation on the entire set of bits in `a`.

```
c = bitandreduce(a)
```

```
c =
    0
```

```

    DataTypeMode: Fixed-point: binary point scaling
    Signedness: Unsigned
    WordLength: 1
    FractionLength: 0
```

Because the bits of `a` do not all have a value of 1, the output has a value of 0.

Perform Bitwise AND Operation on a Range of Bits in a Vector

Create a fixed-point vector.

```
a = fi([12, 4, 8, 15],0,8,0);
disp(bin(a))
```

```
00001100  00000100  00001000  00001111
```

Perform a bitwise AND operation on the bits of each element of *a*, starting at position *fi(4)*.

```
c = bitandreduce(a, fi(4))
```

```
c=1×4 object
```

```
  0    0    0    1
```

```
      DataTypeMode: Fixed-point: binary point scaling
      Signedness:   Unsigned
      WordLength:   1
      FractionLength: 0
```

The only element in output *c* with a value of 1 is the 4th element. This is because it is the only element of *a* that had only 1's between positions *fi(4)* and 1.

Perform Bitwise AND Operation on a Range of Bits in a Matrix

Create a fixed-point matrix.

```
a = fi([7, 8, 1; 5, 9, 5; 8, 37, 2], 0, 8, 0);
disp(bin(a))
```

```
00000111  00001000  00000001
00000101  00001001  00000101
00001000  00100101  00000010
```

Perform a bitwise AND operation on the bits of each element of matrix *a* beginning at position 3 and ending at position 1.

```
c = bitandreduce(a, 3, 1)
```

```
c=3×3 object
```

```
  1    0    0
  0    0    0
  0    0    0
```

```
      DataTypeMode: Fixed-point: binary point scaling
      Signedness:   Unsigned
      WordLength:   1
      FractionLength: 0
```

There is only one element in output *c* with a value of 1. This condition occurs because the corresponding element in *a* is the only element with only 1's between positions 3 and 1.

Input Arguments

a — Input array

scalar | vector | matrix | multidimensional array

Input array, specified as a scalar, vector, matrix, or multidimensional array of `fi` objects.

`bitandreduce` supports both signed and unsigned inputs with arbitrary scaling. The sign and scaling properties do not affect the result type and value. `bitandreduce` performs the operation on a two's complement bit representation of the stored integer.

Data Types: fixed-point `fi`

lidx — Start position of range

scalar

Start position of range specified as a scalar of built-in type. `lidx` represents the position in the range closest to the MSB.

Data Types: `fi`|`single` | `double` | `int8` | `int16` | `int32` | `int64` | `uint8` | `uint16` | `uint32` | `uint64`

ridx — End position of range

scalar

End position of range specified as a scalar of built-in type. `ridx` represents the position in the range closest to the LSB (the bit at position 1).

Data Types: `fi`|`single` | `double` | `int8` | `int16` | `int32` | `int64` | `uint8` | `uint16` | `uint32` | `uint64`

Output Arguments

c — Output array

scalar | vector | matrix | multidimensional array

Output array, specified as a scalar, vector, matrix, or multidimensional array of fixed-point `fi` objects. `c` is unsigned with word length 1.

Extended Capabilities

C/C++ Code Generation

Generate C and C++ code using MATLAB® Coder™.

HDL Code Generation

Generate Verilog and VHDL code for FPGA and ASIC designs using HDL Coder™.

For VHDL®, generates the bitwise AND operator operating on a set of individual slices.

For Verilog®, generates the reduce operator:

```
&a[lidx:ridx]
```

See Also

`bitconcat` | `bitorreduce` | `bitsliceget` | `bitxorreduce`

Introduced in R2007b

bitcmp

Bitwise complement of `fi` object

Syntax

```
c = bitcmp(a)
```

Description

`c = bitcmp(a)` returns the bitwise complement of `fi` object `a`. If `a` has a signed `numericType`, the bit representation of the stored integer is in two's complement representation.

`bitcmp` only supports `fi` objects with fixed-point data types. `a` can be a scalar `fi` object or a vector `fi` object.

Examples

This example shows how to get the bitwise complement of a `fi` object. Consider the following unsigned fixed-point `fi` object with a value of 10, word length 4, and fraction length 0:

```
a = fi(10,0,4,0);  
disp(bin(a))
```

```
1010
```

Complement the values of the bits in `a`:

```
c = bitcmp(a);  
disp(bin(c))
```

```
0101
```

Extended Capabilities

C/C++ Code Generation

Generate C and C++ code using MATLAB® Coder™.

HDL Code Generation

Generate Verilog and VHDL code for FPGA and ASIC designs using HDL Coder™.

See Also

`bitand` | `bitget` | `bitor` | `bitset` | `bitxor`

Introduced before R2006a

bitconcat

Concatenate bits of `fi` objects

Syntax

```
y = bitconcat(a)
y = bitconcat (a, b, ...)
```

Description

`y = bitconcat(a)` concatenates the bits of the elements of fixed-point `fi` input array, `a`.

`y = bitconcat (a, b, ...)` concatenates the bits of the fixed-point `fi` inputs.

Examples

Concatenate the Elements of a Vector

Create a fixed-point vector.

```
a = fi([1,2,5,7],0,4,0);
disp(bin(a))
```

```
0001  0010  0101  0111
```

Concatenate the bits of the elements of `a`.

```
y = bitconcat(a)
```

```
y =
```

```
    4695
```

```
    DataTypeMode: Fixed-point: binary point scaling
    Signedness: Unsigned
    WordLength: 16
    FractionLength: 0
```

```
disp(bin(y))
```

```
0001001001010111
```

The word length of the output, `y`, equals the sum of the word lengths of each element of `a`.

Concatenate the Bits of Two `fi` Objects

Create two fixed-point numbers.

```
a = fi(5,0,4,0);
disp(bin(a))
```

```
0101
```

```
b = fi(10,0,4,0);
disp(bin(b))
```

```
1010
```

Concatenate the bits of the two inputs.

```
y = bitconcat(a,b)
```

```
y =
    90
```

```
        DataTypeMode: Fixed-point: binary point scaling
        Signedness:   Unsigned
        WordLength:   8
        FractionLength: 0
```

```
disp(bin(y))
```

```
01011010
```

The output, *y*, is unsigned with a word length equal to the sum of the word lengths of the two inputs, and a fraction length of 0.

Perform Element-by-Element Concatenation of Two Vectors

When *a* and *b* are both vectors of the same size, `bitconcat` performs element-wise concatenation of the two vectors and returns a vector.

Create two fixed-point vectors of the same size.

```
a = fi([1,2,5,7],0,4,0);
disp(bin(a))
```

```
0001  0010  0101  0111
```

```
b = fi([7,4,3,1],0,4,0);
disp(bin(b))
```

```
0111  0100  0011  0001
```

Concatenate the elements of *a* and *b*.

```
y = bitconcat(a,b)
```

```
y=1×4 object
    23    36    83   113
```

```
        DataTypeMode: Fixed-point: binary point scaling
        Signedness:   Unsigned
        WordLength:   8
        FractionLength: 0
```

```
disp(bin(y))
```

```
00010111  00100100  01010011  01110001
```

The output, *y*, is a vector of the same length as the input vectors, and with a word length equal to the sum of the word lengths of the two input vectors.

Perform Element-by-Element Concatenation of Two Matrices

When the inputs are both matrices of the same size, `bitconcat` performs element-wise concatenation of the two matrices and returns a matrix of the same size.

Create two fixed-point matrices.

```
a = fi([1,2,5;7,4,5;3,1,12],0,4,0);
disp(bin(a))
```

```
0001  0010  0101
0111  0100  0101
0011  0001  1100
```

```
b = fi([6,1,7;7,8,1;9,7,8],0,4,0);
disp(bin(b))
```

```
0110  0001  0111
0111  1000  0001
1001  0111  1000
```

Perform element-by-element concatenation of the bits of *a* and *b*.

```
y = bitconcat(a,b)
```

```
y=3×3 object
```

```
 22  33  87
119  72  81
 57  23  200
```

```
    DataTypeMode: Fixed-point: binary point scaling
    Signedness: Unsigned
    WordLength: 8
    FractionLength: 0
```

```
disp(bin(y))
```

```
00010110  00100001  01010111
01110111  01001000  01010001
00111001  00010111  11001000
```

The output, *y*, is a matrix with word length equal to the sum of the word lengths of *a* and *b*.

Input Arguments

a — Input array

scalar | vector | matrix | multidimensional array

Input array, specified as a scalar, vector, matrix, or multidimensional array of fixed-point `fi` objects. `bitconcat` accepts `varargin` number of inputs for concatenation.

Data Types: fixed-point `fi`

b — Input array

scalar | vector | matrix | multidimensional array

Input array, specified as a scalar, vector, matrix, or multidimensional array of fixed-point `fi` objects. If `b` is nonscalar, it must have the same dimension as the other inputs.

Data Types: fixed-point `fi`

Output Arguments

y — Output array

scalar | vector | matrix | multidimensional array

Output array, specified as a scalar, vector, matrix, or multidimensional array of unsigned fixed-point `fi` objects.

The output array has word length equal to the sum of the word lengths of the inputs and a fraction length of zero. The bit representation of the stored integer is in two's complement representation. Scaling does not affect the result type and value.

If the inputs are all scalar, then `bitconcat` concatenates the bits of the inputs and returns a scalar.

If the inputs are all arrays of the same size, then `bitconcat` performs element-wise concatenation of the bits and returns an array of the same size.

Extended Capabilities

C/C++ Code Generation

Generate C and C++ code using MATLAB® Coder™.

HDL Code Generation

Generate Verilog and VHDL code for FPGA and ASIC designs using HDL Coder™.

For VHDL, generates the concatenation operator: `(a & b)`.

For Verilog, generates the concatenation operator: `{a , b}`.

See Also

`bitand` | `bitcmp` | `bitget` | `bitor` | `bitreplicate` | `bitset` | `bitsliceget` | `bitxor`

Introduced in R2007b

bitget

Get bits at certain positions

Syntax

```
c = bitget(a, bit)
```

Description

`c = bitget(a, bit)` returns the values of the bits at the positions specified by `bit` in `a` as unsigned integers of word length 1.

Examples

Get Bit When Input and Index Are Both Scalar

Consider the following unsigned fixed-point `fi` number with a value of 85, word length 8, and fraction length 0:

```
a = fi(85,0,8,0);  
disp(bin(a))
```

```
01010101
```

Get the binary representation of the bit at position 4:

```
c = bitget(a,4);
```

`bitget` returns the bit at position 4 in the binary representation of `a`.

Get Bit When Input Is a Matrix and the Index Is a fi

Begin with a signed fixed-point 3-by-3 matrix with word length 4 and fraction length 0.

```
a = fi([2 3 4;6 8 2;3 5 1],0,4,0);  
disp(bin(a))
```

```
0010  0011  0100  
0110  1000  0010  
0011  0101  0001
```

Get the binary representation of the bits at a specified position.

```
c = bitget(a,fi(2))
```

```
c=3x3 object  
    1    1    0  
    1    0    1  
    1    0    0
```

```

        DataTypeMode: Fixed-point: binary point scaling
        Signedness: Unsigned
        WordLength: 1
        FractionLength: 0

```

MATLAB® returns a matrix of the bits in position `fi(2)` of `a`. The output matrix has the same dimensions as `a`, and a word length of 1.

Get Bit When Both Input and Index Are Vectors

Begin with a signed fixed-point vector with word length 16, fraction length 4.

```

a = fi([86 6 53 8 1],0,16,4);
disp(bin(a))

```

```

0000010101100000  0000000001100000  0000001101010000  0000000010000000  000000000010000

```

Create a vector that specifies the positions of the bits to get.

```

bit = [1,2,5,7,4]

```

```

bit = 1x5

```

```

     1     2     5     7     4

```

Get the binary representation of the bits of `a` at the positions specified in `bit`.

```

c = bitget(a,bit)

```

```

c=1x5 object
     0     0     1     0     0

```

```

        DataTypeMode: Fixed-point: binary point scaling
        Signedness: Unsigned
        WordLength: 1
        FractionLength: 0

```

`bitget` returns a vector of the bits of `a` at the positions specified in `bit`. The output vector has the same length as inputs, `a` and `bit`, and a word length of 1.

Get Bit When Input Is Scalar and Index Is a Vector

Create a default `fi` object with a value of `pi`.

```

a = fi(pi);
disp(bin(a))

```

```

0110010010001000

```

The default object is signed with a word length of 16.

Create a vector of the positions of the bits you want to get in `a`, and get the binary representation of those bits.

```
bit = fi([15,3,8,2]);
c = bitget(a,bit)
```

```
c=1×4 object
    1    0    1    0

    DataTypeMode: Fixed-point: binary point scaling
    Signedness: Unsigned
    WordLength: 1
    FractionLength: 0
```

MATLAB® returns a vector of the bits in `a` at the positions specified by the index vector, `bit`.

Input Arguments

`a` — Input array

scalar | vector | matrix | multidimensional array

Input array, specified as a scalar, vector, matrix, or multidimensional array of fixed-point `fi` objects. If `a` and `bit` are both nonscalar, they must have the same dimension. If `a` has a signed numeric type, the bit representation of the stored integer is in two's complement representation.

Data Types: fixed-point `fi`

`bit` — Bit index

scalar | vector | matrix | multidimensional array

Bit index, specified as a scalar, vector, matrix or multidimensional array of `fi` objects or built-in data types. If `a` and `bit` are both nonscalar, they must have the same dimension. `bit` must contain integer values between 1 and the word length of `a`, inclusive. The LSB (right-most bit) is specified by bit index 1 and the MSB (left-most bit) is specified by the word length of `a`. `bit` does not need to be a vector of sequential bit positions; it can also be a variable index value.

```
a = fi(pi,0,8);
a.bin
```

```
11001001
```

	MSB				LSB			
bit index	8	7	6	5	4	3	2	1
value	1	1	0	0	1	0	0	1

Data Types: `fi` | `single` | `double` | `int8` | `int16` | `int32` | `int64` | `uint8` | `uint16` | `uint32` | `uint64`

Output Arguments

c — Output array

scalar | vector | matrix | multidimensional array

Output array, specified as an unsigned scalar, vector, matrix, or multidimensional array with `WordLength` 1.

If `a` is an array and `bit` is a scalar, `c` is an unsigned array with word length 1. This unsigned array comprises the values of the bits at position `bit` in each fixed-point element in `a`.

If `a` is a scalar and `bit` is an array, `c` is an unsigned array with word length 1. This unsigned array comprises the values of the bits in `a` at the positions specified in `bit`.

Extended Capabilities

C/C++ Code Generation

Generate C and C++ code using MATLAB® Coder™.

HDL Code Generation

Generate Verilog and VHDL code for FPGA and ASIC designs using HDL Coder™.

For VHDL, generates the slice operator: `a(idx)`.

For Verilog, generates the slice operator: `a[idx]`.

See Also

`bitand` | `bitcmp` | `bitor` | `bitset` | `bitxor`

Introduced before R2006a

bitor

Bitwise OR of two `fi` objects

Syntax

```
c = bitor(a,b)
```

Description

`c = bitor(a,b)` returns the bitwise OR of `fi` objects `a` and `b`. The output is determined as follows:

- Elements in the output array `c` are assigned a value of 1 when the corresponding bit in either input array has a value of 1.
- Elements in the output array `c` are assigned a value of 0 when the corresponding bit in both input arrays has a value of 0.

The `numericType` properties associated with `a` and `b` must be identical. If both inputs have a local `fi`math, their local `fi`math properties must be identical. If the `numericType` is signed, then the bit representation of the stored integer is in two's complement representation.

`a` and `b` must have the same dimensions unless one is a scalar.

`bitor` only supports `fi` objects with fixed-point data types.

Examples

The following example finds the bitwise OR of `fi` objects `a` and `b`.

```
a = fi(-30,1,6,0);  
b = fi(12, 1, 6, 0);  
c = bitor(a,b)
```

```
c =
```

```
-18
```

```
      DataTypeMode: Fixed-point: binary point scaling  
      Signedness: Signed  
      WordLength: 6  
      FractionLength: 0
```

You can verify the result by examining the binary representations of `a`, `b` and `c`.

```
binary_a = a.bin  
binary_b = b.bin  
binary_c = c.bin
```

```
binary_a =
```

```
100010
```

```
binary_b =
```

```
001100
```

```
binary_c =
```

```
101110
```

Extended Capabilities

C/C++ Code Generation

Generate C and C++ code using MATLAB® Coder™.

Usage notes and limitations:

- Slope-bias scaled `fi` objects are not supported.

HDL Code Generation

Generate Verilog and VHDL code for FPGA and ASIC designs using HDL Coder™.

See Also

`bitand` | `bitcmp` | `bitget` | `bitset` | `bitxor`

Introduced before R2006a

bitorreduce

Reduce consecutive slice of bits to one bit by performing bitwise OR operation

Syntax

```
c = bitorreduce(a)
c = bitorreduce(a, lidx)
c = bitorreduce(a, lidx, ridx)
```

Description

`c = bitorreduce(a)` performs a bitwise OR operation on the entire set of bits in the fixed-point input, `a`, and returns the result as an unsigned integer of word length 1.

`c = bitorreduce(a, lidx)` performs a bitwise OR operation on a consecutive range of bits, starting at position `lidx` and ending at the LSB (the bit at position 1).

`c = bitorreduce(a, lidx, ridx)` performs a bitwise OR operation on a consecutive range of bits, starting at position `lidx` and ending at position `ridx`.

The `bitorreduce` arguments must satisfy the following condition:

```
a.WordLength >= lidx >= ridx >= 1
```

Examples

Perform Bitwise OR Operation on an Entire Set of Bits

Create a fixed-point number.

```
a = fi(73,0,8,0);
disp(bin(a))
```

```
01001001
```

Perform a bitwise OR operation on the entire set of bits in `a`.

```
c = bitorreduce(a)
```

```
c =
    1
```

```
    DataTypeMode: Fixed-point: binary point scaling
    Signedness: Unsigned
    WordLength: 1
    FractionLength: 0
```

Because there is at least one bit in `a` with a value of 1, the output has a value of 1.

Perform Bitwise OR Operation on a Range of Bits in a Vector

Create a fixed-point vector.

```
a=fi([12,4,8,15],0,8,0);
disp(bin(a))
```

```
00001100  00000100  00001000  00001111
```

Perform a bitwise OR operation on the bits of each element of `a`, starting at position `fi(4)`.

```
c=bitorreduce(a,fi(4))
```

```
c=1×4 object
```

```
 1     1     1     1
```

```
      DataTypeMode: Fixed-point: binary point scaling
      Signedness:   Unsigned
      WordLength:   1
      FractionLength: 0
```

All of the entries of output `c` have a value of 1 because all of the entries of `a` have at least one bit with a value of 1 between the positions `fi(4)` and 1.

Perform Bitwise OR Operation on a Range of Bits in a Matrix

Create a fixed-point matrix.

```
a = fi([7,8,1;5,9,5;8,37,2],0,8,0);
disp(bin(a))
```

```
00000111  00001000  00000001
00000101  00001001  00000101
00001000  00100101  00000010
```

Perform a bitwise OR operation on the bits of each element of matrix `a` beginning at position 5, and ending at position 2.

```
c = bitorreduce(a,5,2)
```

```
c=3×3 object
```

```
 1     1     0
 1     1     1
 1     1     1
```

```
      DataTypeMode: Fixed-point: binary point scaling
      Signedness:   Unsigned
      WordLength:   1
      FractionLength: 0
```

There is only one element in output `c` that does not have a value of 1. This condition occurs because the corresponding element in `a` is the only element of `a` that does not have any bits with a value of 1 between positions 5 and 2.

Input Arguments

a — Input array

scalar | vector | matrix | multidimensional array

Input array, specified as a scalar, vector, matrix, or multidimensional array of fixed-point `fi` objects.

`bitorreduce` supports both signed and unsigned inputs with arbitrary scaling. The sign and scaling properties do not affect the result type and value. `bitorreduce` performs the operation on a two's complement bit representation of the stored integer.

Data Types: fixed-point `fi`

lidx — Start position of range

scalar

Start position of range specified as a scalar of built-in type. `lidx` represents the position in the range closest to the MSB.

Data Types: `fi`|single | double | int8 | int16 | int32 | int64 | uint8 | uint16 | uint32 | uint64

ridx — End position of range

scalar

End position of range specified as a scalar of built-in type. `ridx` represents the position in the range closest to the LSB (the bit at position 1).

Data Types: `fi`|single | double | int8 | int16 | int32 | int64 | uint8 | uint16 | uint32 | uint64

Output Arguments

c — Output array

scalar | vector | matrix | multidimensional array

Output array, specified as a scalar, vector, matrix, or multidimensional array of fixed-point `fi` objects. `c` is unsigned with word length 1.

Extended Capabilities

C/C++ Code Generation

Generate C and C++ code using MATLAB® Coder™.

HDL Code Generation

Generate Verilog and VHDL code for FPGA and ASIC designs using HDL Coder™.

For VHDL, generates the bitwise OR operator operating on a set of individual slices.

For Verilog, generates the reduce operator:

```
|a[lidx:ridx]
```

See Also

`bitandreduce` | `bitconcat` | `bitsliceget` | `bitxorreduce`

Introduced in R2007b

bitreplicate

Replicate and concatenate bits of `fi` object

Syntax

```
c = bitreplicate(a,n)
```

Description

`c = bitreplicate(a,n)` concatenates the bits in `fi` object `a` `n` times and returns an unsigned fixed-point value. The word length of the output `fi` object `c` is equal to `n` times the word length of `a` and the fraction length of `c` is zero. The bit representation of the stored integer is in two's complement representation.

The input `fi` object can be signed or unsigned. `bitreplicate` concatenates signed and unsigned bits the same way.

`bitreplicate` only supports `fi` objects with fixed-point data types.

`bitreplicate` does not support inputs with complex data types.

Sign and scaling of the input `fi` object does not affect the result type and value.

Examples

The following example uses `bitreplicate` to replicate and concatenate the bits of `fi` object `a`.

```
a = fi(14,0,6,0);  
a_binary = a.bin  
c = bitreplicate(a,2);  
c_binary = c.bin
```

MATLAB returns the following:

```
a_binary =
```

```
001110
```

```
c_binary =
```

```
001110001110
```

Extended Capabilities

C/C++ Code Generation

Generate C and C++ code using MATLAB® Coder™.

HDL Code Generation

Generate Verilog and VHDL code for FPGA and ASIC designs using HDL Coder™.

See Also

bitand | bitconcat | bitget | bitor | bitset | bitsliceget | bitxor

Introduced in R2008a

bitrol

Bitwise rotate left

Syntax

```
c = bitrol(a, k)
```

Description

`c = bitrol(a, k)` returns the value of the fixed-point `fi` object, `a`, rotated left by `k` bits. `bitrol` rotates bits from the most significant bit (MSB) side into the least significant bit (LSB) side. It performs the rotate left operation on the stored integer bits of `a`.

`bitrol` does not check overflow or underflow. It ignores `fimath` properties such as `RoundingMode` and `OverflowAction`.

`a` and `c` have the same `fimath` and `numericType` properties.

Examples

Rotate the Bits of a `fi` Object Left

Create an unsigned fixed-point `fi` object with a value of 10, word length 4, and fraction length 0.

```
a = fi(10,0,4,0);  
disp(bin(a))
```

```
1010
```

Rotate `a` left 1 bit.

```
disp(bin(bitrol(a,1)))
```

```
0101
```

Rotate `a` left 2 bits.

```
disp(bin(bitrol(a,2)))
```

```
1010
```

Rotate Bits in a Vector Left

Create a vector of `fi` objects.

```
a = fi([1,2,5,7],0,4,0)
```

```
a=1×4 object  
    1     2     5     7
```

```

        DataTypeMode: Fixed-point: binary point scaling
        Signedness: Unsigned
        WordLength: 4
        FractionLength: 0

```

```
disp(bin(a))
```

```
0001  0010  0101  0111
```

Rotate the bits in vector a left 1 bit.

```
disp(bin(bitrol(a,1)))
```

```
0010  0100  1010  1110
```

Rotate Bits Left Using `fi` to Specify Number of Bits to Rotate

Create an unsigned fixed-point `fi` object with a value 10, word length 4, and fraction length 0.

```
a = fi(10,0,4,0);
```

```
disp(bin(a))
```

```
1010
```

Rotate a left 1 bit where k is a `fi` object.

```
disp(bin(bitrol(a,fi(1))))
```

```
0101
```

Input Arguments

a — Data that you want to rotate

scalar | vector | matrix | multidimensional array

Data that you want to rotate, specified as a scalar, vector, matrix, or multidimensional array of `fi` objects. `a` can be signed or unsigned.

Data Types: fixed-point `fi`

Complex Number Support: Yes

k — Number of bits to rotate

non-negative, integer-valued scalar

Number of bits to rotate, specified as a non-negative integer-valued scalar `fi` object or built-in numeric type. `k` can be greater than the word length of `a`. This value is always normalized to `mod(a.WordLength, k)`.

Data Types: `fi` | `single` | `double` | `int8` | `int16` | `int32` | `int64` | `uint8` | `uint16` | `uint32` | `uint64`

Extended Capabilities

C/C++ Code Generation

Generate C and C++ code using MATLAB® Coder™.

HDL Code Generation

Generate Verilog and VHDL code for FPGA and ASIC designs using HDL Coder™.

For VHDL, generates the `rol` operator.

For Verilog, generates the following expression (where `wl` is the word length of `a`):

```
a << idx || a >> wl - idx
```

See Also

[bitconcat](#) | [bitror](#) | [bitshift](#) | [bitsliceget](#) | [bitsll](#) | [bitsra](#) | [bitsrl](#)

Introduced in R2007b

bitror

Bitwise rotate right

Syntax

```
c = bitror(a, k)
```

Description

`c = bitror(a, k)` returns the value of the fixed-point `fi` object, `a`, rotated right by `k` bits. `bitror` rotates bits from the least significant bit (LSB) side into the most significant bit (MSB) side. It performs the rotate right operation on the stored integer bits of `a`.

`bitror` does not check overflow or underflow. It ignores `fimath` properties such as `RoundingMode` and `OverflowAction`.

`a` and `c` have the same `fimath` and `numericType` properties.

Examples

Rotate Bits of a `fi` Object Right

Create an unsigned fixed-point `fi` object with a value 5, word length 4, and fraction length 0.

```
a = fi(5,0,4,0);
disp(bin(a))
```

```
0101
```

Rotate `a` right 1 bit.

```
disp(bin(bitror(a,1)))
```

```
1010
```

Rotate `a` right 2 bits.

```
disp(bin(bitror(a,2)))
```

```
0101
```

Rotate Bits in a Vector Right

Create a vector of `fi` objects.

```
a = fi([1,2,5,7],0,4,0);
disp(bin(a))
```

```
0001  0010  0101  0111
```

Rotate the bits in vector `a` right 1 bit.

```
disp(bin(bitror(a,fi(1))))  
1000  0001  1010  1011
```

Rotate Bits Right Using `fi` to Specify Number of Bits to Rotate

Create an unsigned fixed-point `fi` object with a value 5, word length 4, and fraction length 0.

```
a = fi(5,0,4,0);  
disp(bin(a))
```

```
0101
```

Rotate `a` right 1 bit where `k` is a `fi` object.

```
disp(bin(bitror(a,fi(1))))  
1010
```

Input Arguments

a — Data that you want to rotate

scalar | vector | matrix | multidimensional array

Data that you want to rotate, specified as a scalar, vector, matrix, or multidimensional array of `fi` objects. `a` can be signed or unsigned.

Data Types: fixed-point `fi`

Complex Number Support: Yes

k — Number of bits to rotate

non-negative, integer-valued scalar

Number of bits to rotate, specified as a non-negative integer-valued scalar `fi` object or built-in numeric type. `k` can be greater than the word length of `a`. This value is always normalized to `mod(a.WordLength,k)`.

Data Types: `fi` | `single` | `double` | `int8` | `int16` | `int32` | `int64` | `uint8` | `uint16` | `uint32` | `uint64`

Extended Capabilities

C/C++ Code Generation

Generate C and C++ code using MATLAB® Coder™.

HDL Code Generation

Generate Verilog and VHDL code for FPGA and ASIC designs using HDL Coder™.

For VHDL, generates the `rор` operator.

For Verilog, generates the following expression (where `wl` is the word length of `a`):

```
a >> idx || a << wl - idx
```

See Also

[bitconcat](#) | [bitrol](#) | [bitshift](#) | [bitsliceget](#) | [bitsll](#) | [bitsra](#) | [bitsrl](#)

Introduced in R2007b

bitset

Set bits at certain positions

Syntax

```
c = bitset(a, bit)
c = bitset(a, bit, v)
```

Description

`c = bitset(a, bit)` returns the value of `a` with position `bit` set to 1 (on).

`c = bitset(a, bit, v)` returns the value of `a` with position `bit` set to `v`.

Examples

Set the Bit at a Certain Position

Begin with an unsigned fixed-point `fi` number with a value of 5, word length 4, and fraction length 0.

```
a = fi(5,0,4,0);
disp(bin(a))
```

```
0101
```

Set the bit at position 4 to 1 (on).

```
c = bitset(a,4);
disp(bin(c))
```

```
1101
```

Set the Bit at a Certain Position in a Vector

Consider the following fixed-point vector with word length 4 and fraction length 0.

```
a = fi([0 1 8 2 4],0,4,0);
disp(bin(a))
```

```
0000  0001  1000  0010  0100
```

In each element of vector `a`, set the bits at position 2 to 1.

```
c = bitset(a,2,1);
disp(bin(c))
```

```
0010  0011  1010  0010  0110
```

Set the Bit at a Certain Position with Fixed Point Index

Consider the following fixed-point scalar with a value of 5.

```
a = fi(5,0,4,0);
disp(bin(a))
```

```
0101
```

Set the bit at position `fi(2)` to 1.

```
c = bitset(a,fi(2),1);
disp(bin(c))
```

```
0111
```

Set the Bit When Index Is a Vector

Create a `fi` object with a value of `pi`.

```
a = fi(pi);
disp(bin(a))
```

```
0110010010001000
```

In this case, `a` is signed with a word length of 16.

Create a vector of the bit positions in `a` that you want to set to on. Then, get the binary representation of the resulting `fi` vector.

```
bit = fi([15,3,8,2]);
c = bitset(a,bit);
disp(bin(c))
```

```
0110010010001000  0110010010001100  0110010010001000  0110010010001010
```

Input Arguments

a — Input array

scalar | vector | matrix | multidimensional array

Input array, specified as a scalar, vector, matrix, or multidimensional array of fixed-point `fi` objects. If `a` has a signed `numericType`, the bit representation of the stored integer is in two's complement representation.

Data Types: fixed-point `fi`

bit — Bit index

scalar | vector | matrix | multidimensional array

Bit index, specified as a scalar, vector, matrix, or multidimensional array of `fi` objects or built-in data types. `bit` must be a number between 1 and the word length of `a`, inclusive. The LSB (right-most bit) is specified by bit index 1 and the MSB (left-most bit) is specified by the word length of `a`.

```
a = fi(pi,0,8);
a.bin
```

```
11001001
```

	MSB							LSB
bit index	8	7	6	5	4	3	2	1
value	1	1	0	0	1	0	0	1

Data Types: `fi|single | double | int8 | int16 | int32 | int64 | uint8 | uint16 | uint32 | uint64`

v – Bit value

`scalar | vector | matrix | multidimensional array`

Bit value of `a` at index `bit`, specified as a scalar, vector, matrix, or multidimensional array of `fi` objects or built-in data types. `v` can have values of 0, or 1. Any value other than 0 is automatically set to 1. When `v` is nonscalar, it must have the same dimensions as one of the other inputs.

Data Types: `fi|single | double | int8 | int16 | int32 | int64 | uint8 | uint16 | uint32 | uint64`

Output Arguments

c – Output array

`scalar | vector | matrix | multidimensional array`

Output array, specified as a scalar, vector, matrix, or multidimensional array of `fi` objects.

Extended Capabilities

C/C++ Code Generation

Generate C and C++ code using MATLAB® Coder™.

HDL Code Generation

Generate Verilog and VHDL code for FPGA and ASIC designs using HDL Coder™.

See Also

`bitand | bitcmp | bitget | bitor | bitxor`

Introduced before R2006a

bitshift

Shift bits specified number of places

Syntax

```
c = bitshift(a, k)
```

Description

`c = bitshift(a, k)` returns the value of `a` shifted by `k` bits. The input `fi` object `a` may be a scalar value or a vector and can be any fixed-point numeric type. The output `fi` object `c` has the same numeric type as `a`. `k` must be a scalar value and a MATLAB built-in numeric type.

The `OverflowAction` property of `a` is obeyed, but the `RoundingMethod` is always `Floor`. If obeying the `RoundingMethod` property of `a` is important, try using the `pow2` function.

When the overflow action is `Saturate` the sign bit is always preserved. The sign bit is also preserved when the overflow action is `Wrap`, and `k` is negative. When the overflow action is `Wrap` and `k` is positive, the sign bit is not preserved.

- When `k` is positive, 0-valued bits are shifted in on the right.
- When `k` is negative, and `a` is unsigned, or a signed and positive `fi` object, 0-valued bits are shifted in on the left.
- When `k` is negative and `a` is a signed and negative `fi` object, 1-valued bits are shifted in on the left.

Examples

This example highlights how changing the `OverflowAction` property of the `fimath` object can change the results returned by the `bitshift` function. Consider the following signed fixed-point `fi` object with a value of 3, word length 16, and fraction length 0:

```
a = fi(3,1,16,0);
```

By default, the `OverflowAction` `fimath` property is `Saturate`. When `a` is shifted such that it overflows, it is saturated to the maximum possible value:

```
for k=0:16,b=bitshift(a,k);...
disp([num2str(k,'%02d'),' ' ,bin(b)]);end
```

```
00. 0000000000000011
01. 0000000000000110
02. 0000000000001100
03. 0000000000011000
04. 000000000110000
05. 000000001100000
06. 000000011000000
07. 000000110000000
08. 000001100000000
09. 000011000000000
```

```
10. 0000110000000000
11. 0001100000000000
12. 0011000000000000
13. 0110000000000000
14. 0111111111111111
15. 0111111111111111
16. 0111111111111111
```

Now change `OverflowAction` to `Wrap`. In this case, most significant bits shift off the “top” of `a` until the value is zero:

```
a = fi(3,1,16,0,'OverflowAction','Wrap');
for k=0:16,b=bitshift(a,k);...
disp([num2str(k,'%02d'),' ' ',bin(b)]);end
```

```
00. 0000000000000011
01. 0000000000000110
02. 0000000000001100
03. 0000000000011000
04. 000000000110000
05. 000000001100000
06. 000000011000000
07. 000000110000000
08. 000001100000000
09. 000011000000000
10. 000110000000000
11. 001100000000000
12. 011000000000000
13. 011000000000000
14. 110000000000000
15. 100000000000000
16. 000000000000000
```

Extended Capabilities

C/C++ Code Generation

Generate C and C++ code using MATLAB® Coder™.

HDL Code Generation

Generate Verilog and VHDL code for FPGA and ASIC designs using HDL Coder™.

For efficient HDL code generation, use `bitsll`, `bitsrl`, or `bitsra` instead of `bitshift`.

See Also

`bitand` | `bitcmp` | `bitget` | `bitor` | `bitset` | `bitsll` | `bitsra` | `bitsrl` | `bitxor` | `pow2`

Introduced before R2006a

bitsliceget

Get consecutive slice of bits

Syntax

```
c = bitsliceget(a)
c = bitsliceget(a, lidx)
c = bitsliceget(a, lidx, ridx)
```

Description

`c = bitsliceget(a)` returns the entire set of bits in the fixed-point input `a`.

`c = bitsliceget(a, lidx)` returns a consecutive slice of bits from `a`, starting at position `lidx` and ending at the LSB (the bit at position 1).

`c = bitsliceget(a, lidx, ridx)` returns a consecutive slice of bits from `a`, starting at position `lidx` and ending at position `ridx`.

The `bitsliceget` arguments must satisfy the following condition:

```
a.WordLength >= lidx >= ridx >= 1
```

Examples

Get Entire Set of Bits

Begin with the following fixed-point number.

```
a = fi(85,0,8,0);
disp(bin(a))
```

```
01010101
```

Get the entire set of bits of `a`.

```
c = bitsliceget(a);
disp(bin(c))
```

```
01010101
```

Get a Slice of Consecutive Bits with Unspecified Endpoint

Begin with the following fixed-point number.

```
a = fi(85,0,8,0);
disp(bin(a))
```

```
01010101
```

Get the binary representation of the consecutive bits, starting at position 6.

```
c = bitsliceget(a,6);
disp(bin(c))

010101
```

Get a Slice of Consecutive Bits with Fixed-Point Indexes

Begin with the following fixed-point number.

```
a = fi(85,0,8,0);
disp(bin(a))

01010101
```

Get the binary representation of the consecutive bits from `fi(6)` to `fi(2)`.

```
c = bitsliceget(a,fi(6),fi(2));
disp(bin(c))

01010
```

Get a Specified Set of Consecutive Bits from Each Element of a Matrix

Begin with the following unsigned fixed-point 3-by-3 matrix.

```
a = fi([2 3 4;6 8 2;3 5 1],0,4,0);
disp(bin(a))

0010    0011    0100
0110    1000    0010
0011    0101    0001
```

Get the binary representation of a consecutive set of bits of matrix `a`. For each element, start at position 4 and end at position 2.

```
c = bitsliceget(a,4,2);
disp(bin(c))

001    001    010
011    100    001
001    010    000
```

Input Arguments

a — Input array

scalar | vector | matrix | multidimensional array

Input array, specified as a scalar, vector, matrix, or multidimensional array of fixed-point `fi` objects. If `a` has a signed `numericType`, the bit representation of the stored integer is in two's complement representation.

Data Types: fixed-point `fi`

lidx — Start position for slice

scalar

Start position of slice specified as a scalar of built-in type. `lidx` represents the position in the slice closest to the MSB.

Data Types: `fi`|`single` | `double` | `int8` | `int16` | `int32` | `int64` | `uint8` | `uint16` | `uint32` | `uint64`

ridx — End position for slice

scalar

End position of slice specified as a scalar of built-in type. `ridx` represents the position in the slice closest to the LSB (the bit at position 1).

Data Types: `fi`|`single` | `double` | `int8` | `int16` | `int32` | `int64` | `uint8` | `uint16` | `uint32` | `uint64`

Output Arguments

c — Output array

scalar | vector | matrix | multidimensional array

Fixed-point `fi` output, specified as a scalar, vector, matrix, or multidimensional array with no scaling. The word length is equal to slice length, `lidx - ridx + 1`.

If `lidx` and `ridx` are equal, `bitsliceget` only slices one bit, and `bitsliceget(a, lidx, ridx)` is the same as `bitget(a, lidx)`.

Extended Capabilities

C/C++ Code Generation

Generate C and C++ code using MATLAB® Coder™.

HDL Code Generation

Generate Verilog and VHDL code for FPGA and ASIC designs using HDL Coder™.

See Also

`bitand` | `bitcmp` | `bitget` | `bitor` | `bitset` | `bitxor`

Introduced in R2007b

bitsll

Bit shift left logical

Syntax

```
c = bitsll(a, k)
```

Description

`c = bitsll(a, k)` returns the result of a logical left shift by `k` bits on input `a` for fixed-point operations. `bitsll` shifts zeros into the positions of bits that it shifts left. The function does not check overflow or underflow. For floating-point operations, `bitsll` performs a multiply by 2^k .

`bitsll` ignores `fimath` properties such as `RoundingMode` and `OverflowAction`.

When `a` is a `fi` object, `a` and `c` have the same associated `fimath` and `numericType` objects.

Examples

Shift Left a Signed fi Input

Shift a signed `fi` input left by 1 bit.

Create a `fi` object, and display its binary value.

```
a = fi(10,0,4,0);  
disp(bin(a))
```

```
1010
```

Shift `a` left by 1 bit, and display its binary value.

```
disp(bin(bitsll(a,1)))
```

```
0100
```

Shift `a` left by 1 more bit.

```
disp(bin(bitsll(a,2)))
```

```
1000
```

Shift Left Using a fi Shift Value

Shift left a built-in `int8` input using a `fi` shift value.

```
k = fi(2);  
a = int8(16);  
bitsll(a,k)
```

```
ans = int8
    64
```

Shift Left a Built-in int8 Input

Use `bitsll` to shift an `int8` input left by 2 bits.

```
a = int8(4);
bitsll(a,2)
```

```
ans = int8
    16
```

Shift Left a Floating-Point Input

Scale a floating-point double input by 2^3 .

```
a = double(16);
bitsll(a,3)
```

```
ans = 128
```

Input Arguments

a — Data that you want to shift

scalar | vector | matrix | multidimensional array

Data that you want to shift, specified as a scalar, vector, matrix, or multidimensional array of `fi` objects or built-in numeric types.

Data Types: `fi` | `single` | `double` | `int8` | `int16` | `int32` | `int64` | `uint8` | `uint16` | `uint32` | `uint64`

Complex Number Support: Yes

k — Number of bits to shift

non-negative integer-valued scalar

Number of bits to shift, specified as a non-negative integer-valued scalar `fi` object or built-in numeric type.

Data Types: `fi` | `single` | `double` | `int8` | `int16` | `int32` | `int64` | `uint8` | `uint16` | `uint32` | `uint64`

Extended Capabilities

C/C++ Code Generation

Generate C and C++ code using MATLAB® Coder™.

Usage notes and limitations:

- Generated code might not handle out of range shifting.

GPU Code Generation

Generate CUDA® code for NVIDIA® GPUs using GPU Coder™.

Usage notes and limitations:

- Generated code might not handle out of range shifting.

HDL Code Generation

Generate Verilog and VHDL code for FPGA and ASIC designs using HDL Coder™.

Generates `sll` operator in VHDL code.

Generates `<<` operator in Verilog code.

See Also

`bitconcat` | `bitrol` | `bitror` | `bitshift` | `bitsra` | `bitsrl` | `pow2`

Introduced in R2007b

bitsra

Bit shift right arithmetic

Syntax

```
c=bitsra(a,k)
```

Description

`c=bitsra(a,k)` returns the result of an arithmetic right shift by k bits on input a for fixed-point operations. For floating-point operations, it performs a multiply by 2^{-k} .

If the input is unsigned, `bitsra` shifts zeros into the positions of bits that it shifts right. If the input is signed, `bitsra` shifts the most significant bit (MSB) into the positions of bits that it shifts right.

`bitsra` ignores `fimath` properties such as `RoundingMode` and `OverflowAction`.

When a is a `fi` object, a and c have the same associated `fimath` and `numericType` objects.

Examples

Shift Right a Signed fi Input

Create a signed fixed-point `fi` object with a value of -8 , word length 4, and fraction length 0. Then display the binary value of the object.

```
a = fi(-8,1,4,0);
disp(bin(a))
```

```
1000
```

Shift a right by 1 bit.

```
disp(bin(bitsra(a,1)))
```

```
1100
```

`bitsra` shifts the MSB into the position of the bit that it shifts right.

Shift Right a Built-in int8 Input

Use `bitsra` to shift an `int8` input right by 2 bits.

```
a = int8(64);
bitsra(a,2)
```

```
ans = int8
    16
```

Shift Right Using a `fi` Shift Value

Shift right a built-in `int8` input using a `fi` shift value.

```
k = fi(2);  
a = int8(64);  
bitsra(a,k)
```

```
ans = int8  
    16
```

Shift Right a Floating-Point Input

Scale a floating-point double input by 2^{-3} .

```
a = double(128);  
bitsra(a,3)
```

```
ans = 16
```

Input Arguments

a — Data that you want to shift

scalar | vector | matrix | multidimensional array

Data that you want to shift, specified as a scalar, vector, matrix, or multidimensional array of `fi` objects or built-in numeric types.

Data Types: `fi` | `single` | `double` | `int8` | `int16` | `int32` | `int64` | `uint8` | `uint16` | `uint32` | `uint64`

Complex Number Support: Yes

k — Number of bits to shift

non-negative integer-valued scalar

Number of bits to shift, specified as a non-negative integer-valued scalar `fi` object or built-in numeric type.

Data Types: `fi` | `single` | `double` | `int8` | `int16` | `int32` | `int64` | `uint8` | `uint16` | `uint32` | `uint64`

Extended Capabilities

C/C++ Code Generation

Generate C and C++ code using MATLAB® Coder™.

Usage notes and limitations:

- Generated code might not handle out of range shifting.

GPU Code Generation

Generate CUDA® code for NVIDIA® GPUs using GPU Coder™.

Usage notes and limitations:

- Generated code might not handle out of range shifting.

HDL Code Generation

Generate Verilog and VHDL code for FPGA and ASIC designs using HDL Coder™.

Generates sra operator in VHDL code.

Generates >>> operator in Verilog code.

See Also

`bitshift` | `bitsll` | `bitsrl` | `pow2`

Introduced in R2007b

bitsrl

Bit shift right logical

Syntax

```
c = bitsrl(a, k)
```

Description

`c = bitsrl(a, k)` returns the result of a logical right shift by `k` bits on input `a` for fixed-point operations. `bitsrl` shifts zeros into the positions of bits that it shifts right. It does not check overflow or underflow.

`bitsrl` ignores `fimath` properties such as `RoundingMode` and `OverflowAction`.

When `a` is a `fi` object, `a` and `c` have the same associated `fimath` and `numericType` objects.

Examples

Shift right a signed fi input

Shift a signed `fi` input right by 1 bit.

Create a signed fixed-point `fi` object with a value of -8, word length 4, and fraction length 0 and display its binary value.

```
a = fi(-8,1,4,0);  
disp(bin(a))
```

```
1000
```

Shift `a` right by 1 bit, and display the binary value.

```
disp(bin(bitsrl(a,1)))
```

```
0100
```

`bitsrl` shifts a zero into the position of the bit that it shifts right.

Shift right using a fi shift value

Shift right a built-in `int8` input using a `fi` shift value.

```
k = fi(2);  
a = int8(64);  
bitsrl(a,k)
```

```
ans = int8  
    16
```

Shift right a built-in uint8 input

Use `bitsrl` to shift a `uint8` input right by 2 bits.

```

a = uint8(64);
bitsrl(a,2)

ans = uint8
    16

```

Input Arguments

a — Data that you want to shift

scalar | vector | matrix | multidimensional array

Data that you want to shift, specified as a scalar, vector, matrix, or multidimensional array.

Data Types: `fi` | `int8` | `int16` | `int32` | `int64` | `uint8` | `uint16` | `uint32` | `uint64`

Complex Number Support: Yes

k — Number of bits to shift

non-negative integer-valued scalar

Number of bits to shift, specified as a non-negative integer-valued scalar.

Data Types: `fi`|`single` | `double` | `int8` | `int16` | `int32` | `int64` | `uint8` | `uint16` | `uint32` | `uint64`

Extended Capabilities

C/C++ Code Generation

Generate C and C++ code using MATLAB® Coder™.

Usage notes and limitations:

- Generated code might not handle out of range shifting.

GPU Code Generation

Generate CUDA® code for NVIDIA® GPUs using GPU Coder™.

Usage notes and limitations:

- Generated code might not handle out of range shifting.

HDL Code Generation

Generate Verilog and VHDL code for FPGA and ASIC designs using HDL Coder™.

Generates `srl` operator in VHDL.

Generates `>>` operator in Verilog.

See Also

`bitconcat` | `bitrol` | `bitror` | `bitshift` | `bitsliceget` | `bitsll` | `bitsra` | `pow2`

Introduced in R2007b

bitxor

Bitwise exclusive OR of two `fi` objects

Syntax

```
c = bitxor(a,b)
```

Description

`c = bitxor(a,b)` returns the bitwise exclusive OR of `fi` objects `a` and `b`. The output is determined as follows:

- Elements in the output array `c` are assigned a value of 1 when exactly one of the corresponding bits in the input arrays has a value of 1.
- Elements in the output array `c` are assigned a value of 0 when the corresponding bits in the input arrays have the same value (e.g. both 1's or both 0's).

The `numericType` properties associated with `a` and `b` must be identical. If both inputs have a local `fi`math, their local `fi`math properties must be identical. If the `numericType` is signed, then the bit representation of the stored integer is in two's complement representation.

`a` and `b` must have the same dimensions unless one is a scalar.

`bitxor` only supports `fi` objects with fixed-point data types.

Examples

The following example finds the bitwise exclusive OR of `fi` objects `a` and `b`.

```
a = fi(-28,1,6,0);
b = fi(12, 1, 6, 0);
c = bitxor(a,b)
```

```
c =
```

```
    -24
```

```

        DataTypeMode: Fixed-point: binary point scaling
           Signedness: Signed
            WordLength: 6
       FractionLength: 0
```

You can verify the result by examining the binary representations of `a`, `b` and `c`.

```
binary_a = a.bin
binary_b = b.bin
binary_c = c.bin
```

```
binary_a =
```

```
100100
```

```
binary_b =
```

```
001100
```

```
binary_c =
```

```
101000
```

Extended Capabilities

C/C++ Code Generation

Generate C and C++ code using MATLAB® Coder™.

Usage notes and limitations:

- Slope-bias scaled `fi` objects are not supported.

HDL Code Generation

Generate Verilog and VHDL code for FPGA and ASIC designs using HDL Coder™.

See Also

`bitand` | `bitcmp` | `bitget` | `bitor` | `bitset`

Introduced before R2006a

bitxorreduce

Reduce consecutive slice of bits to one bit by performing bitwise exclusive OR operation

Syntax

```
c = bitxorreduce(a)
c = bitxorreduce(a, lidx)
c = bitxorreduce(a, lidx, ridx)
```

Description

`c = bitxorreduce(a)` performs a bitwise exclusive OR operation on the entire set of bits in the fixed-point input, `a`. It returns the result as an unsigned integer of word length 1.

`c = bitxorreduce(a, lidx)` performs a bitwise exclusive OR operation on a consecutive range of bits. This operation starts at position `lidx` and ends at the LSB (the bit at position 1).

`c = bitxorreduce(a, lidx, ridx)` performs a bitwise exclusive OR operation on a consecutive range of bits, starting at position `lidx` and ending at position `ridx`.

The `bitxorreduce` arguments must satisfy the following condition:

```
a.WordLength >= lidx >= ridx >= 1
```

Examples

Perform Bitwise Exclusive OR Operation on an Entire Set of Bits

Create a fixed-point number.

```
a = fi(73,0,8,0);
disp(bin(a))
```

```
01001001
```

Perform a bitwise exclusive OR operation on the entire set of bits in `a`.

```
c = bitxorreduce(a)
```

```
c =
     1
```

```
    DataTypeMode: Fixed-point: binary point scaling
    Signedness: Unsigned
    WordLength: 1
    FractionLength: 0
```

Perform Bitwise Exclusive OR Operation on a Range of Bits in a Vector

Create a fixed-point vector.

```
a = fi([12,4,8,15],0,8,0);
disp(bin(a))
```

```
00001100  00000100  00001000  00001111
```

Perform a bitwise exclusive OR operation on the bits of each element of `a`, starting at position `fi(4)`.

```
c = bitxorreduce(a,fi(4))
```

```
c=1×4 object
```

```
  0   1   1   0
```

```
      DataTypeMode: Fixed-point: binary point scaling
      Signedness:   Unsigned
      WordLength:   1
      FractionLength: 0
```

Perform a Bitwise Exclusive OR Operation on a Range of Bits in a Matrix

Create a fixed-point matrix.

```
a = fi([7,8,1;5,9,5;8,37,2],0,8,0);
disp(bin(a))
```

```
00000111  00001000  00000001
00000101  00001001  00000101
00001000  00100101  00000010
```

Perform a bitwise exclusive OR operation on the bits of each element of matrix `a` beginning at position 5 and ending at position 2.

```
c = bitxorreduce(a,5,2)
```

```
c=3×3 object
```

```
  0   1   0
  1   1   1
  1   1   1
```

```
      DataTypeMode: Fixed-point: binary point scaling
      Signedness:   Unsigned
      WordLength:   1
      FractionLength: 0
```

Input Arguments

a — Input array

scalar | vector | matrix | multidimensional array

Input array, specified as a scalar, vector, matrix, or multidimensional array of fixed-point `fi` objects.

bitxorreduce supports both signed and unsigned inputs with arbitrary scaling. The sign and scaling properties do not affect the result type and value. bitxorreduce performs the operation on a two's complement bit representation of the stored integer.

Data Types: fixed-point `fi`

lidx — Start position of range

scalar

Start position of range specified as a scalar of built-in type. `lidx` represents the position in the range closest to the MSB.

Data Types: `fi` | `single` | `double` | `int8` | `int16` | `int32` | `int64` | `uint8` | `uint16` | `uint32` | `uint64`

ridx — End position of range

scalar

End position of range specified as a scalar of built-in type. `ridx` represents the position in the range closest to the LSB (the bit at position 1).

Data Types: `fi`|`single` | `double` | `int8` | `int16` | `int32` | `int64` | `uint8` | `uint16` | `uint32` | `uint64`

Output Arguments

c — Output array

scalar | vector | matrix | multidimensional array

Output array, specified as a scalar, vector, matrix, or multidimensional array of fixed-point `fi` objects. `c` is unsigned with word length 1.

Extended Capabilities

C/C++ Code Generation

Generate C and C++ code using MATLAB® Coder™.

HDL Code Generation

Generate Verilog and VHDL code for FPGA and ASIC designs using HDL Coder™.

For VHDL, generates a set of individual slices.

For Verilog, generates the reduce operator:

```
^a[lidx:ridx]
```

See Also

bitandreduce | bitconcat | bitorreduce | bitsliceget

Introduced in R2007b

buildInstrumentedMex

Generate compiled C code function including logging instrumentation

Syntax

```
buildInstrumentedMex fcn -options  
buildInstrumentedMex fcn_1... fcn_n -options -coder
```

Description

`buildInstrumentedMex fcn -options` translates the MATLAB file `fcn.m` to a MEX function and enables instrumentation for logging minimum and maximum values of all named and intermediate variables. Optionally, you can enable instrumentation for log2 histograms of all named, intermediate and expression values. The general syntax and options of `buildInstrumentedMex` and `fiaccel` are the same, except `buildInstrumentedMex` has no `fi` object restrictions and supports the `'-coder'` option.

`buildInstrumentedMex fcn_1... fcn_n -options -coder` translates the MATLAB functions `fcn_1` through `fcn_n` to a MEX function and enables instrumentation for logging minimum and maximum values of all named and intermediate variables. Generating a MEX function for multiple entry-point functions requires the `'-coder'` option.

Examples

Create an Instrumented MEX Function

Create an instrumented MEX function. Run a test bench, then view logged results.

Create a temporary directory, then import an example function from Fixed-Point Designer.

```
tempdirObj=fidemo.fiTempdir('buildInstrumentedMex')  
copyfile(fullfile(matlabroot,'toolbox','fixedpoint',...  
    'fidemos','fi_m_radix2fft_withscaling.m'),...  
    'testfft.m','f')
```

Define prototype input arguments.

```
n = 128;  
x = complex(zeros(n,1));  
W = coder.Constant(fidemo.fi_radix2twiddles(n));
```

Generate an instrumented MEX function. Use the `-o` option to specify the MEX function name. Use the `-histogram` option to compute histograms. (If you have a MATLAB Coder license, you may want to also add the `-coder` option. In this case, use `buildInstrumentedMex testfft -coder -o testfft_instrumented -args {x,W}` instead of the following line of code.)

Note Like `fiaccel`, `buildInstrumentedMex` generates a MEX function. To generate C code, see the MATLAB Coder `codegen` function.

```
buildInstrumentedMex testfft -o testfft_instrumented...
-args {x,W} -histogram
```

Run a test file to record instrumentation results. Call `showInstrumentationResults` to open the report. View the simulation minimum and maximum values and whole number status by pausing over a variable in the report. You can also see proposed data types for double precision numbers in the table.

```
for i=1:20
    y = testfft_instrumented(randn(size(x)));
end
```

```
showInstrumentationResults testfft_instrumented
```

The screenshot shows the MATLAB Instrumentation Report interface. The top part displays the MATLAB source code for 'testfft.m'. A tooltip is visible over the code, showing variable information for 'LL2': Size: 1 x 7, Class: int32, Complex: No. Below the code is a table with columns: Name, Type, Sim Min, Sim Max, Class, Always Whole Number, and Sim Min. The table lists variables like x, w, n, t, LL, rr, LL2, temp, L, and r with their respective simulation ranges and data types.

Name	Type	Sim Min	Sim Max	Class	Always Whole Number	Sim Min	Sim Max
x	I/O	128 x 1		complex double	No	-3.722211247178794	3.325535825655795
w	Input	127 x 1		complex double	No	-1	1
n	Local	1 x 1		double	Yes	128	128
t	Local	1 x 1		double	Yes	7	7
LL	Local	1 x 7		int32	Yes	2	128
rr	Local	1 x 7		int32	Yes	1	64
LL2	Local	1 x 7		int32	Yes	1	64
temp	Local	1 x 1		complex double	No	-3.102703946701695	3.090313522579606
L	Local	1 x 1		int32	Yes	2	128
r	Local	1 x 1		int32	Yes	1	64

View the histogram for a variable by clicking  in the **Variables** tab.

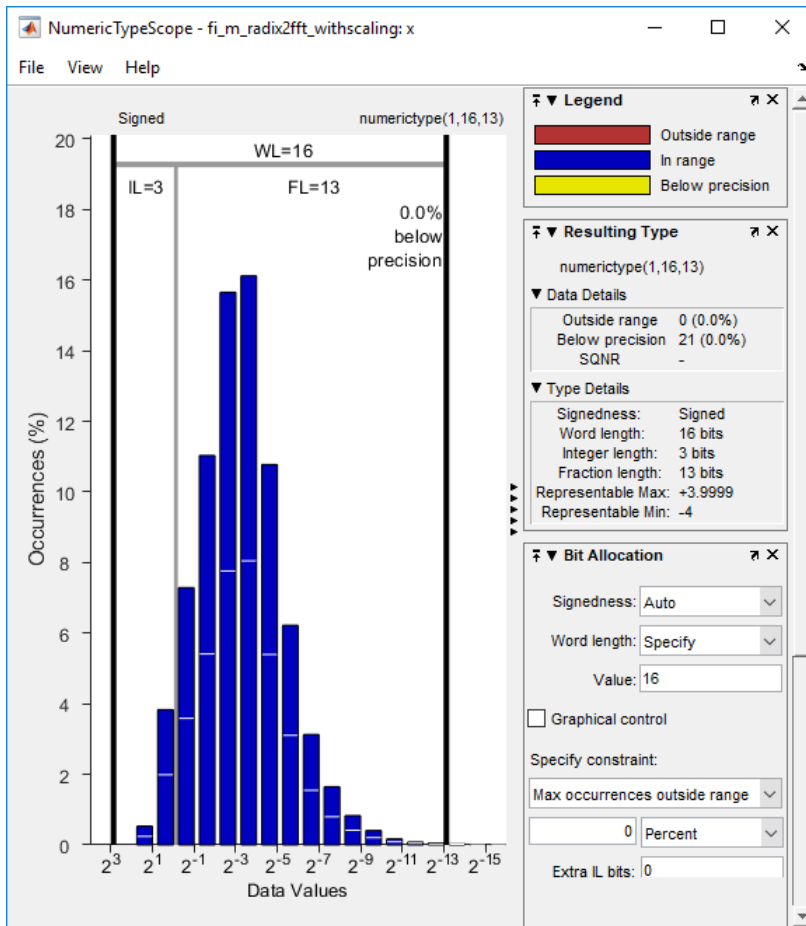

For information on the figure, refer to the `NumericTypeScope` reference page.

Close the histogram display and then, clear the results log.

```
clearInstrumentationResults testfft_instrumented;
```

Clear the MEX function, then delete temporary files.

```
clear testfft_instrumented;
tempdirObj.cleanup;
```

Build an Instrumented MEX Function for Multiple Entry Point Functions

In a local writable folder, create the functions `ep1.m` and `ep2.m`.

```
function y1 = ep1(u) %#codegen
y1 = u;
end
```

```
function y2 = ep2(u, v) %#codegen
y2 = u + v;
end
```

Generate an instrumented MEX function for the two entry-point functions. Use the `-o` option to specify the name of the MEX function. Use the `-histogram` option to compute histograms. Use the `-coder` option to enable generating multiple entry points with the `buildInstrumentedMex` function.

```
u = 1:100;
v = 5:104;
buildInstrumentedMex -o sharedmex ...
ep1 -args {u} ... % Entry point 1
ep2 -args {u, v} ... % Entry point 2
-histogram -coder
```

Call the first entry-point function using the generated MEX function.

```
y1 = sharedmex('ep1', u);
```

Call the second entry-point function using the generated MEX function.

```
y2 = sharedmex('ep2', u, v);
```

Show the instrumentation results.

```
showInstrumentationResults sharedmex
```

The screenshot shows the MATLAB IDE interface. The main window displays the source code for `ep1.m`:

```
1 function y1 = ep1(u) %#codegen
2 y1 = u;
3 end
```

Below the code editor, the **VARIABLES** table is visible, showing the instrumentation results for variables `y1` and `u`:

Name	Type	Size	Class	Always Whole Number	Sim Min	Sim Max
y1	Output	1 × 100	double	Yes	1	100
u	Input	1 × 100	double	Yes	1	100

Note Generating a MEX function for multiple entry-point functions using the `buildInstrumentedMex` function requires a MATLAB Coder license.

Input Arguments

fcn — Entry-point functions to instrument

function name

MATLAB entry-point functions to be instrumented, specified as a function existing in the current working folder or on the path. The entry-point functions must be suitable for code generation. For more information, see “Make the MATLAB Code Suitable for Code Generation” (MATLAB Coder).

options — Compiler options

option value | space delimited list of option values

Choice of compiler options. `buildInstrumentedMex` gives precedence to individual command-line options over options specified using a configuration object. If command-line options conflict, the rightmost option prevails.

<code>-args</code> <i>example_inputs</i>	Define the size, class, and complexity of all MATLAB function inputs. Use the values in <i>example_inputs</i> to define these properties. <i>example_inputs</i> must be a cell array that specifies the same number and order of inputs as the MATLAB function.
<code>-coder</code>	Use MATLAB Coder software to compile the MEX file, instead of the default Fixed-Point Designer <code>fiaccel</code> function. This option removes <code>fiaccel</code> restrictions and allows for full code generation support. You must have a MATLAB Coder license to use this option.
<code>-config</code> <i>config_object</i>	Specify MEX generation parameters, based on <i>config_object</i> , defined as a MATLAB variable using <code>coder.mexconfig</code> . For example: <pre>cfg = coder.mexconfig;</pre>

- `-d out_folder` Store generated files in the absolute or relative path specified by *out_folder*. If the folder specified by *out_folder* does not exist, `buildInstrumentedMex` creates it for you.
- If you do not specify the folder location, `buildInstrumentedMex` generates files in the default folder:
- fiaccel/mex/fcn*.
- fcn* is the name of the MATLAB function specified at the command line.
- The function does not support the following characters in folder names: asterisk (*), question mark (?), dollar (\$), and pound (#).
- `-g` Compiles the MEX function in debug mode, with optimization turned off. If not specified, `buildinstrumentedMex` generates the MEX function in optimized mode.
- `-global global_values` Specify initial values for global variables in MATLAB file. Use the values in cell array *global_values* to initialize global variables in the function you compile. The cell array should provide the name and initial value of each global variable. You must initialize global variables before compiling with `buildInstrumentedMex`. If you do not provide initial values for global variables using the `-global` option, `buildInstrumentedMex` checks for the variable in the MATLAB global workspace. If you do not supply an initial value, `buildInstrumentedMex` generates an error.
- The generated MEX code and MATLAB each have their own copies of global data. To ensure consistency, you must synchronize their global data whenever the two interact. If you do not synchronize the data, their global variables might differ.
- `-histogram` Compute the log2 histogram for all named, intermediate and expression values. A histogram column appears in the code generation report table.
- `-I include_path` Add *include_path* to the beginning of the code generation path.
- `buildInstrumentedMex` searches the code generation path *first* when converting MATLAB code to MEX code.

<code>-launchreport</code>	Generate and open a code generation report. If you do not specify this option, <code>buildInstrumentedMex</code> generates a report only if error or warning messages occur or you specify the <code>-report</code> option.
<code>-o output_file_name</code>	Generate the MEX function with the base name <code>output_file_name</code> plus a platform-specific extension. <code>output_file_name</code> can be a file name or include an existing path. If you do not specify an output file name, the base name is <code>fcn_mex</code> , which allows you to run the original MATLAB function and the MEX function and compare the results.
<code>-O optimization_option</code>	Optimize generated MEX code, based on the value of <code>optimization_option</code> : <ul style="list-style-type: none"> • <code>enable:inline</code> — Enable function inlining • <code>disable:inline</code> — Disable function inlining If not specified, <code>buildInstrumentedMex</code> uses inlining for optimization.
<code>-report</code>	Generate a code generation report. If you do not specify this option, <code>buildInstrumentedMex</code> generates a report only if error or warning messages occur or you specify the <code>-launchreport</code> option.

Tips

- You cannot instrument MATLAB functions provided with the software. If your top-level function is such a MATLAB function, nothing is logged. You also cannot instrument scripts.
- Instrumentation results are accumulated every time the instrumented MEX function is called. Use `clearInstrumentationResults` to clear previous results in the log.
- Some coding patterns pass a significant amount of data, but only use a small portion of that data. In such cases, you may see degraded performance when using `buildInstrumentedMex`. In the following pattern, `subfun` only uses one element of input array, `A`. For normal execution, the amount of time to execute `subfun` once remains constant regardless of the size of `A`. The function `topfun` calls `subfun` `N` times, and thus the total time to execute `topfun` is proportional to `N`. When instrumented, however, the time to execute `subfun` once becomes proportional to `N^2`. This change occurs because the minimum and maximum data are calculated over the entire array. When `A` is large, the calculations can lead to significant performance degradation. Therefore, whenever possible, you should pass only the data that the function actually needs.

```
function A = topfun(A)
    N = numel(A);
    for i=1:N
        A(i) = subfun(A,i);
    end
```



```
end
function b = subfun(A,i)
    b = 0.5 * A(i);
end

function A = topfun(A)
    N = numel(A);
    for i=1:N
        A(i) = subfun(A(i));
    end
end
function b = subfun(a)
    b = 0.5 * a;
end
```

See Also

[NumericTypeScope](#) | [clearInstrumentationResults](#) | [codegen](#) | [fiaccl](#) | [mex](#) | [showInstrumentationResults](#)

Introduced in R2011b

cast

Cast variable to different data type

Syntax

```
b = cast(a, 'like', p)
```

Description

`b = cast(a, 'like', p)` converts `a` to the same `numericType`, complexity (real or complex), and `fimath` as `p`. If `a` and `p` are both real, then `b` is also real. Otherwise, `b` is complex.

Examples

Convert an int8 Value to Fixed Point

Define a scalar 8-bit integer.

```
a = int8(5);
```

Create a signed `fi` object with word length of 24 and fraction length of 12.

```
p = fi([], 1, 24, 12);
```

Convert `a` to fixed point with `numericType`, complexity (real or complex), and `fimath` of the specified `fi` object, `p`.

```
b = cast(a, 'like', p)
```

```
b =  
    5
```

```
    DataTypeMode: Fixed-point: binary point scaling  
    Signedness: Signed  
    WordLength: 24  
    FractionLength: 12
```

Convert an Array to Fixed Point

Define a 2-by-3 matrix of ones.

```
A = ones(2, 3);
```

Create a signed `fi` object with word length of 16 and fraction length of 8.

```
p = fi([], 1, 16, 8);
```

Convert `A` to the same data type and complexity (real or complex) as `p`.

```
B = cast(A, 'like', p)
```

```
B=2×3 object
```

```
  1     1     1
  1     1     1
```

```
    DataTypeMode: Fixed-point: binary point scaling
    Signedness: Signed
    WordLength: 16
    FractionLength: 8
```

Write MATLAB Code That Is Independent of Data Types

Write a MATLAB algorithm that you can run with different data types without changing the algorithm itself. To reuse the algorithm, define the data types separately from the algorithm.

This approach allows you to define a baseline by running the algorithm with floating-point data types. You can then test the algorithm with different fixed-point data types and compare the fixed-point behavior to the baseline without making any modifications to the original MATLAB code.

Write a MATLAB function, `my_filter`, that takes an input parameter, `T`, which is a structure that defines the data types of the coefficients and the input and output data.

```
function [y,z] = my_filter(b,a,x,z,T)
    % Cast the coefficients to the coefficient type
    b = cast(b,'like',T.coeffs);
    a = cast(a,'like',T.coeffs);
    % Create the output using zeros with the data type
    y = zeros(size(x),'like',T.data);
    for i = 1:length(x)
        y(i) = b(1)*x(i) + z(1);
        z(1) = b(2)*x(i) + z(2) - a(2) * y(i);
        z(2) = b(3)*x(i)          - a(3) * y(i);
    end
end
```

Write a MATLAB function, `zeros_ones_cast_example`, that calls `my_filter` with a floating-point step input and a fixed-point step input, and then compares the results.

```
function zeros_ones_cast_example

    % Define coefficients for a filter with specification
    % [b,a] = butter(2,0.25)
    b = [0.097631072937818    0.195262145875635    0.097631072937818];
    a = [1.0000000000000000  -0.942809041582063    0.333333333333333];

    % Define floating-point types
    T_float.coeffs = double([]);
    T_float.data   = double([]);

    % Create a step input using ones with the
    % floating-point data type
    t = 0:20;
    x_float = ones(size(t), 'like', T_float.data);
```

```

% Initialize the states using zeros with the
% floating-point data type
z_float = zeros(1,2,'like',T_float.data);

% Run the floating-point algorithm
y_float = my_filter(b,a,x_float,z_float,T_float);

% Define fixed-point types
T_fixed.coeffs = fi([],true,8,6);
T_fixed.data   = fi([],true,8,6);

% Create a step input using ones with the
% fixed-point data type
x_fixed = ones(size(t),'like',T_fixed.data);

% Initialize the states using zeros with the
% fixed-point data type
z_fixed = zeros(1,2,'like',T_fixed.data);

% Run the fixed-point algorithm
y_fixed = my_filter(b,a,x_fixed,z_fixed,T_fixed);

% Compare the results
coder.extrinsic('clf','subplot','plot','legend')
clf
subplot(211)
plot(t,y_float,'co-',t,y_fixed,'kx-')
legend('Floating-point output','Fixed-point output')
title('Step response')
subplot(212)
plot(t,y_float - double(y_fixed),'rs-')
legend('Error')
figure(gcf)
end

```

Input Arguments

a — Variable that you want to cast to a different data type

fi object | numeric variable

Variable, specified as a fi object or numeric variable.

Complex Number Support: Yes

p — Prototype

fi object | numeric variable

Prototype, specified as a fi object or numeric variable. To use the prototype to specify a complex object, you must specify a value for the prototype. Otherwise, you do not need to specify a value.

Complex Number Support: Yes

Tips

Using the `b = cast(a, 'like', p)` syntax to specify data types separately from algorithm code allows you to:

- Reuse your algorithm code with different data types.
- Keep your algorithm uncluttered with data type specifications and switch statements for different data types.
- Improve readability of your algorithm code.
- Switch between fixed-point and floating-point data types to compare baselines.
- Switch between variations of fixed-point settings without changing the algorithm code.

See Also

`cast` | `ones` | `zeros`

Topics

“Implement FIR Filter Algorithm for Floating-Point and Fixed-Point Types using `cast` and `zeros`”

“Manual Fixed-Point Conversion Workflow”

“Manual Fixed-Point Conversion Best Practices”

Introduced in R2013a

cast64BitFiToInt

Cast `fi` object types that can be exactly represented to a 64-bit integer data type

Syntax

```
y = cast64BitFiToInt(u)
```

Description

`y = cast64BitFiToInt(u)` casts the input `u` to an equivalent 64-bit integer data type when possible.

If the input `u` is a `fi` object that can be represented exactly by an `int64` or `uint64` data type, then the output is this built-in data type. If `u` is a `fi` object that cannot be exactly represented by a built-in data type, or if it is already a built-in data type, then the output is the same as the input.

Examples

Cast a `fi` Object to an Equivalent Integer Type

Use the `castFiToInt` and `cast64BitFiToInt` functions to cast `fi` objects to equivalent integer data types.

Create a signed `fi` variable with a 16-bit word length and zero fraction length. This is equivalent to an `int16` data type. Cast the variable to the equivalent integer data type using the `castFiToInt` function.

```
u = fi(25,1,16,0);  
y1 = castFiToInt(u)
```

```
y1 =
```

```
int16
```

```
25
```

The `cast64BitFiToInt` function casts only 64-bit word length `fi` objects with zero fraction length to an equivalent integer data type. All other input data types retain their original data type.

In this example, because the input is not a 64-bit word length `fi`, the output is the same as the input.

```
y2 = cast64BitFiToInt(u)
```

```
y2 =
```

```
25
```

```
DataTypeMode: Fixed-point: binary point scaling  
Signedness: Signed  
WordLength: 16  
FractionLength: 0
```

When you pass a `fi` object with a 64-bit word length and zero fraction length into the `cast64BitFiToInt` function, the output is an `int64`.

```
u = fi(25,1,64,0)
y3 = cast64BitFiToInt(u)
```

```
y3 =
    int64
    25
```

When the input is a `fi` object with a non-zero fraction length, both functions return the original `fi` object because the input cannot be represented by an integer data type.

```
u = fi(pi,1,64,32);
y4 = cast64BitFiToInt(u)
```

```
y4 =
    3.1416
        DataTypeMode: Fixed-point: binary point scaling
        Signedness: Signed
        WordLength: 64
        FractionLength: 32
```

```
y5 = castFiToInt(u)
```

```
y5 =
    3.1416
        DataTypeMode: Fixed-point: binary point scaling
        Signedness: Signed
        WordLength: 64
        FractionLength: 32
```

Input Arguments

u — Numeric input

scalar | vector | matrix | multidimensional array

Numeric input array, specified as a scalar, vector, matrix, or multidimensional array.

Data Types: double | single | half | int8 | int16 | int32 | int64 | uint8 | uint16 | uint32 | uint64 | fi

Complex Number Support: Yes

Output Arguments

y — Numeric output

scalar | vector | matrix | multidimensional array

Numeric output, returned as a scalar, vector, matrix, or multidimensional array with the same value and dimensions as the input.

If the input `u` is a `fi` object that can be represented exactly by an `int64` or `uint64` data type, then the output is this built-in data type. If `u` is a `fi` object that cannot be exactly represented by a built-in data type, or if it is already a built-in data type, then the output is the same as the input.

See Also

`cast64BitIntToFi` | `castFiToInt` | `castFiToMATLAB` | `castIntToFi`

Introduced in R2020a

cast64BitIntToFi

Cast 64-bit integer types to an equivalent `fi` object type

Syntax

```
y = cast64BitIntToFi(u)
```

Description

`y = cast64BitIntToFi(u)` casts the input variable `u` to an equivalent 64-bit `fi` object when the data type of `u` is a 64-bit integer type. Otherwise, the output has the same data type as the input.

Examples

Cast an Integer to a `fi` Object

Use the `castIntToFi` and `cast64BitIntToFi` functions to cast integer data types in your code to equivalent `fi` objects.

Create a variable with a signed 16-bit integer data type. Cast the variable to an equivalent `fi` object using the `castIntToFi` function.

```
u = int16(25);
y1 = castIntToFi(u)
```

```
y1 =
```

```
    25
```

```
        DataTypeMode: Fixed-point: binary point scaling
           Signedness: Signed
           WordLength: 16
      FractionLength: 0
```

The output `fi` object has the same word length and signedness as the input, and zero fraction length.

The `cast64BitIntToFi` function casts only 64-bit integer data types to an equivalent `fi` object. All other input data types retain their data type.

In this example, because the input is not an `int64` or `uint64` data type, the output remains an `int16`.

```
y2 = cast64BitIntToFi(u)
```

```
y2 =
```

```
    int16
```

```
    25
```

When you pass an `int64` into the `cast64BitIntToFi` function, the output is a `fi` object with a 64-bit word length and zero fraction length.

```
u = int64(25);  
y3 = castIntToFi(u)
```

```
y3 =
```

```
    25
```

```
        DataTypeMode: Fixed-point: binary point scaling  
        Signedness: Signed  
        WordLength: 64  
        FractionLength: 0
```

Input Arguments

u — Numeric input

scalar | vector | matrix | multidimensional array

Numeric input array, specified as a scalar, vector, matrix, or multidimensional array.

Data Types: double | single | half | int8 | int16 | int32 | int64 | uint8 | uint16 | uint32 | uint64 | fi

Complex Number Support: Yes

Output Arguments

y — Numeric output

scalar | vector | matrix | multidimensional array

Numeric output, returned as a scalar, vector, matrix, or multidimensional array with the same value and dimensions as the input.

When the data type of `u` is a 64-bit integer type, the output is a `fi` object with a 64-bit word length, fraction length of zero, and the same signedness as the input. Otherwise, the output has the same data type as the input.

See Also

`cast64BitFiToInt` | `castFiToInt` | `castFiToMATLAB` | `castIntToFi`

Introduced in R2020a

castFiToInt

Cast fi object to equivalent integer data type

Syntax

```
y = castFiToInt(u)
```

Description

`y = castFiToInt(u)` casts the input `u` to an equivalent MATLAB integer data type when possible.

If the input `u` is a `fi` object type that can be represented exactly by an integer data type, then the output is this integer data type. If `u` is a `fi` object that cannot be exactly represented by a built-in data type, or if it is already a built-in data type, then the output is the same as the input.

Examples

Cast a fi Object to an Equivalent Integer Type

Use the `castFiToInt` and `cast64BitFiToInt` functions to cast `fi` objects to equivalent integer data types.

Create a signed `fi` variable with a 16-bit word length and zero fraction length. This is equivalent to an `int16` data type. Cast the variable to the equivalent integer data type using the `castFiToInt` function.

```
u = fi(25,1,16,0);
y1 = castFiToInt(u)
```

```
y1 =
    int16
     25
```

The `cast64BitFiToInt` function casts only 64-bit word length `fi` objects with zero fraction length to an equivalent integer data type. All other input data types retain their original data type.

In this example, because the input is not a 64-bit word length `fi`, the output is the same as the input.

```
y2 = cast64BitFiToInt(u)
```

```
y2 =
     25
```

```
    DataTypeMode: Fixed-point: binary point scaling
    Signedness: Signed
    WordLength: 16
    FractionLength: 0
```

When you pass a `fi` object with a 64-bit word length and zero fraction length into the `cast64BitFiToInt` function, the output is an `int64`.

```
u = fi(25,1,64,0)
y3 = cast64BitFiToInt(u)
```

```
y3 =
    int64
    25
```

When the input is a `fi` object with a non-zero fraction length, both functions return the original `fi` object because the input cannot be represented by an integer data type.

```
u = fi(pi,1,64,32);
y4 = cast64BitFiToInt(u)
```

```
y4 =
    3.1416
        DataTypeMode: Fixed-point: binary point scaling
        Signedness: Signed
        WordLength: 64
        FractionLength: 32
```

```
y5 = castFiToInt(u)
```

```
y5 =
    3.1416
        DataTypeMode: Fixed-point: binary point scaling
        Signedness: Signed
        WordLength: 64
        FractionLength: 32
```

Input Arguments

u — Numeric input

scalar | vector | matrix | multidimensional array

Numeric input array, specified as a scalar, vector, matrix, or multidimensional array.

Data Types: double | single | half | int8 | int16 | int32 | int64 | uint8 | uint16 | uint32 | uint64 | fi

Complex Number Support: Yes

Output Arguments

y — Numeric output

scalar | vector | matrix | multidimensional array

Numeric output, returned as a scalar, vector, matrix, or multidimensional array with the same value and dimensions as the input.

See Also

[cast64BitFiToInt](#) | [cast64BitIntToFi](#) | [castFiToMATLAB](#) | [castIntToFi](#)

Introduced in R2020a

castFiToMATLAB

Cast `fi` object type to an equivalent built-in MATLAB data type

Syntax

```
y = castFiToMATLAB(u)
```

Description

`y = castFiToMATLAB(u)` casts the input `u` to an equivalent MATLAB built-in data type when possible.

If the input `u` is a `fi` object type that can be represented exactly by a built-in MATLAB data type, then the output is this built-in data type. If `u` is a `fi` object type that cannot be exactly represented by a built-in data type, or if it is already a built-in data type, then the output is the same as the input.

Examples

Cast a `fi` Object to an Equivalent Built-In MATLAB Type

Use the `castFiToMATLAB` function to cast `fi` objects to equivalent built-in MATLAB data types.

Create a signed `fi` variable with a 16-bit word length and zero fraction length. This is equivalent to an `int16` data type. Cast the variable to the equivalent MATLAB data type using the `castFiToMATLAB` function.

```
u = fi(25,1,16,0);  
y1 = castFiToMATLAB(u)
```

```
y1 =  
  
    int16  
  
    25
```

When the input is a `fi` object with a non-zero fraction length, the function returns the original `fi` object because the input cannot be represented by a built-in data type.

```
u = fi(pi,1,64,32);  
y2 = castFiToMATLAB(u)
```

```
y2 =  
  
    3.1416  
  
    DataTypeMode: Fixed-point: binary point scaling  
    Signedness: Signed  
    WordLength: 64  
    FractionLength: 32
```

When the input is a double-precision `fi` object, the function returns a double with the same value.

```
T = numerictype('Double');
u = fi(25,T)

u =

    25

    DataTypeMode: Double

y3 = castFiToMATLAB(u)
class(y3)

y3 =

    25

ans =

    'double'
```

Input Arguments

u — Numeric input

scalar | vector | matrix | multidimensional array

Numeric input array, specified as a scalar, vector, matrix, or multidimensional array.

Data Types: double | single | half | int8 | int16 | int32 | int64 | uint8 | uint16 | uint32 | uint64 | fi

Complex Number Support: Yes

Output Arguments

y — Numeric output

scalar | vector | matrix | multidimensional array

Numeric output, returned as a scalar, vector, matrix, or multidimensional array with the same value and dimensions as the input.

If the input `u` is a `fi` object that can be represented exactly by a built-in MATLAB data type, then the output is this built-in data type. If `u` is a `fi` object that cannot be exactly represented by a built-in data type, or if it is already a built-in data type, then the output is the same as the input.

See Also

[cast64BitFiToInt](#) | [cast64BitIntToFi](#) | [castFiToInt](#) | [castIntToFi](#)

Introduced in R2020a

castIntToFi

Cast an integer data type to equivalent `fi` type

Syntax

```
y = castIntToFi(u)
```

Description

`y = castIntToFi(u)` casts the input variable `u` to an equivalent `fi` object when `u` is one of the built-in MATLAB integer data types (`int8`, `uint8`, `int16`, `uint16`, `int32`, `uint32`, `int64`, `uint64`).

When `u` is not one of the built-in integer data types, the output has the same data type as the input.

Examples

Cast an Integer to a `fi` Object

Use the `castIntToFi` and `cast64BitIntToFi` functions to cast integer data types in your code to equivalent `fi` objects.

Create a variable with a signed 16-bit integer data type. Cast the variable to an equivalent `fi` object using the `castIntToFi` function.

```
u = int16(25);  
y1 = castIntToFi(u)
```

```
y1 =
```

```
    25
```

```
        DataTypeMode: Fixed-point: binary point scaling  
          Signedness: Signed  
         WordLength: 16  
    FractionLength: 0
```

The output `fi` object has the same word length and signedness as the input, and zero fraction length.

The `cast64BitIntToFi` function casts only 64-bit integer data types to an equivalent `fi` object. All other input data types retain their data type.

In this example, because the input is not an `int64` or `uint64` data type, the output remains an `int16`.

```
y2 = cast64BitIntToFi(u)
```

```
y2 =
```

```
    int16
```

```
    25
```

When you pass an `int64` into the `cast64BitIntToFi` function, the output is a `fi` object with a 64-bit word length and zero fraction length.

```
u = int64(25);
y3 = castIntToFi(u)
```

```
y3 =
```

```
    25
```

```
        DataTypeMode: Fixed-point: binary point scaling
        Signedness: Signed
        WordLength: 64
        FractionLength: 0
```

Input Arguments

u — Numeric input

scalar | vector | matrix | multidimensional array

Numeric input array, specified as a scalar, vector, matrix, or multidimensional array.

Data Types: double | single | half | int8 | int16 | int32 | int64 | uint8 | uint16 | uint32 | uint64 | fi

Complex Number Support: Yes

Output Arguments

y — Fixed-point output

fi object | scalar | vector | matrix | multidimensional array

Numeric output, returned as a scalar, vector, matrix, or multidimensional array with the same value and dimensions as the input.

When the data type of `u` is an integer type, the output is a `fi` object with the same word length and signedness as the input, and a fraction length of zero. Otherwise, the output has the same data type as the input.

See Also

`cast64BitFiToInt` | `cast64BitIntToFi` | `castFiToInt` | `castFiToMATLAB`

Introduced in R2020a

ceil

Rounds toward positive infinity

Syntax

```
y = ceil(a)
```

Description

`y = ceil(a)` rounds `fi` object `a` to the nearest integer in the direction of positive infinity and returns the result in `fi` object `y`.

Examples

Use `ceil` on a Signed `fi` Object

The following example demonstrates how the `ceil` function affects the `numericType` properties of a signed `fi` object with a word length of 8 and a fraction length of 3.

```
a = fi(pi,1,8,3)
```

```
a =  
    3.1250
```

```
        DataTypeMode: Fixed-point: binary point scaling  
        Signedness: Signed  
        WordLength: 8  
        FractionLength: 3
```

```
y = ceil(a)
```

```
y =  
    4
```

```
        DataTypeMode: Fixed-point: binary point scaling  
        Signedness: Signed  
        WordLength: 6  
        FractionLength: 0
```

The following example demonstrates how the `ceil` function affects the `numericType` properties of a signed `fi` object with a word length of 8 and a fraction length of 12.

```
a = fi(0.025,1,8,12)
```

```
a =  
    0.0249
```

```
        DataTypeMode: Fixed-point: binary point scaling  
        Signedness: Signed  
        WordLength: 8  
        FractionLength: 12
```

```
y = ceil(a)
```

```
y =
     1
```

```

    DataTypeMode: Fixed-point: binary point scaling
    Signedness: Signed
    WordLength: 2
    FractionLength: 0
```

Compare Rounding Methods

The functions `ceil`, `fix`, and `floor` differ in the way they round `fi` objects:

- The `ceil` function rounds values to the nearest integer toward positive infinity.
- The `fix` function rounds values to the nearest integer toward zero.
- The `floor` function rounds values to the nearest integer toward negative infinity.

This example illustrates these differences for a given `fi` input object `a`.

```
a = fi([-2.5,-1.75,-1.25,-0.5,0.5,1.25,1.75,2.5]');
y = [a ceil(a) fix(a) floor(a)]
```

```

y=8x4 object
-2.5000 -2.0000 -2.0000 -3.0000
-1.7500 -1.0000 -1.0000 -2.0000
-1.2500 -1.0000 -1.0000 -2.0000
-0.5000  0         0         -1.0000
 0.5000  1.0000  0         0
 1.2500  2.0000  1.0000  1.0000
 1.7500  2.0000  1.0000  1.0000
 2.5000  3.0000  2.0000  2.0000
```

```

    DataTypeMode: Fixed-point: binary point scaling
    Signedness: Signed
    WordLength: 16
    FractionLength: 13
```

```
plot(a,y); legend('a','ceil(a)','fix(a)','floor(a)','location','NW');
```

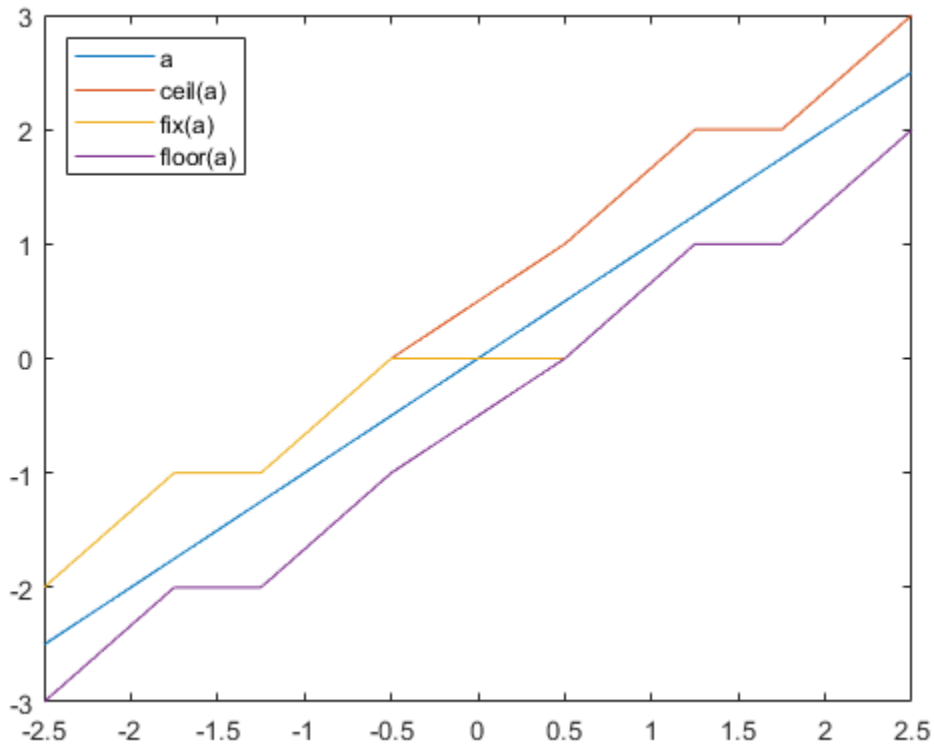

Input Arguments

a — Input `fi` array

scalar | vector | matrix | multidimensional array

Input `fi` array, specified as scalar, vector, matrix, or multidimensional array.

For complex `fi` objects, the imaginary and real parts are rounded independently.

`ceil` does not support `fi` objects with nontrivial slope and bias scaling. Slope and bias scaling is trivial when the slope is an integer power of 2 and the bias is 0.

Data Types: `fi`

Complex Number Support: Yes

Algorithms

- `y` and `a` have the same `fimath` object and `DataType` property.
- When the `DataType` property of `a` is `single`, `double`, or `boolean`, the `numericType` of `y` is the same as that of `a`.
- When the fraction length of `a` is zero or negative, `a` is already an integer, and the `numericType` of `y` is the same as that of `a`.

- When the fraction length of a is positive, the fraction length of y is 0, its sign is the same as that of a , and its word length is the difference between the word length and the fraction length of a , plus one bit. If a is signed, then the minimum word length of y is 2. If a is unsigned, then the minimum word length of y is 1.

Extended Capabilities

C/C++ Code Generation

Generate C and C++ code using MATLAB® Coder™.

HDL Code Generation

Generate Verilog and VHDL code for FPGA and ASIC designs using HDL Coder™.

See Also

convergent | fix | floor | nearest | round

Introduced in R2008a

ceilDiv

Round the result of division toward positive infinity

Syntax

```
y = ceilDiv(x,d)
y = ceilDiv(x,d,m)
```

Description

`y = ceilDiv(x,d)` returns the result of x/d rounded to the nearest integer value in the direction of positive infinity.

`y = ceilDiv(x,d,m)` returns the result of x/d rounded to the nearest multiple of m in the direction of positive infinity.

The datatype of y is calculated such that the wordlength and fraction length are of a sufficient size to contain both the largest and smallest possible solutions given the data type of x , and the values of d and m .

Examples

Divide and Round to Ceil

Perform a division operation and round to the nearest integer value in the direction of positive infinity.

```
ceilDiv(int16(201),10)
```

```
ans =
```

```
21
```

```
DataTypeMode: Fixed-point: binary point scaling
Signedness: Signed
WordLength: 14
FractionLength: 0
```

Perform a division operation and round to the nearest multiple of 7 in the direction of positive infinity.

```
ceilDiv(int16(201),10,5)
```

```
ans =
```

```
25
```

```
DataTypeMode: Fixed-point: binary point scaling
Signedness: Signed
```

WordLength: 14
FractionLength: 0

Input Arguments

x — Dividend

scalar

Dividend, specified as a scalar.

Data Types: `single` | `double` | `int8` | `int16` | `int32` | `int64` | `uint8` | `uint16` | `uint32` | `uint64` | `logical` | `fi`

d — Divisor

scalar

Divisor, specified as a scalar.

Data Types: `single` | `double` | `int8` | `int16` | `int32` | `int64` | `uint8` | `uint16` | `uint32` | `uint64` | `logical` | `fi`

m — Value to round to nearest multiple of

1 (default) | scalar

Value to round to nearest multiple of, specified as a scalar.

Data Types: `single` | `double` | `int8` | `int16` | `int32` | `int64` | `uint8` | `uint16` | `uint32` | `uint64` | `logical` | `fi`

Output Arguments

y — Result of division and round to ceiling

scalar

Result of division and round to ceiling, returned as a scalar.

The datatype of `y` is calculated such that the wordlength and fraction length are of a sufficient size to contain both the largest and smallest possible solutions given the data type of `x`, and the values of `d` and `m`.

Extended Capabilities

C/C++ Code Generation

Generate C and C++ code using MATLAB® Coder™.

Slope-bias representation is not supported for fixed-point data types.

Fixed-Point Conversion

Design and simulate fixed-point systems using Fixed-Point Designer™.

Slope-bias representation is not supported for fixed-point data types.

See Also

`fixDiv` | `floorDiv` | `nearestDiv`

Introduced in R2021a

clearInstrumentationResults

Clear results logged by instrumented, compiled C code function

Syntax

```
clearInstrumentationResults('mex_fcn')
clearInstrumentationResults mex_fcn
clearInstrumentationResults all
```

Description

`clearInstrumentationResults('mex_fcn')` clears the results logged from calling the instrumented MEX function `mex_fcn`.

`clearInstrumentationResults mex_fcn` is alternative syntax for clearing the log.

`clearInstrumentationResults all` clears the results from all instrumented MEX functions.

Input Arguments

`mex_fcn`

Instrumented MEX function created using `buildInstrumentedMex`.

Examples

Run a test bench to log instrumentation, then use `clearInstrumentationResults` to clear the log.

- 1 Create a temporary directory, then import an example function from Fixed-Point Designer.

```
tempdirObj=fidemo.fiTempdir('showInstrumentationResults')
copyfile(fullfile(matlabroot,'toolbox','fixedpoint',...
    'fidemos','fi_m_radix2fft_withscaling.m'),...
    'testfft.m','f')
```

- 2 Define prototype input arguments.

```
n = 128;
x = complex(fi(zeros(n,1), 'DataType', 'ScaledDouble'));
W = coder.Constant(fi(fidemo.fi_radix2twiddles(n)));
```

- 3 Generate an instrumented MEX function. Use the `-o` option to specify the MEX function name.

```
buildInstrumentedMex testfft -o testfft_instrumented -args {x,W}
```

- 4 Run a test bench to record instrumentation results. Call `showInstrumentationResults` to open a report. View the simulation minimum and maximum values and whole number status by pausing over a variable in the report.

```
for i=1:20
    y = testfft_instrumented(cast(2*rand(size(x))-1,'like',x));
end
```

```
showInstrumentationResults testfft_instrumented
```

The screenshot shows the MATLAB environment with the following details:

- Function List:** testfft.m, fi_radix2fft_withscaling, fi_bitreverse.m, fi_bitreverse
- Code Snippet:**

```

1 function x = fi_radix2fft_withscaling(x, w)
2 %FI_M_RADIX2FFT_WITHSCALING Radix-2 FFT example with scaling at each stage.
3 % Y = FI_M_RADIX2FFT_WITHSCALING(X, W) computes the radix-2 FFT of
4 % input vector X with twiddle-factors W with scaling by 1/2 at each stage.
5 % Input X is assumed to be complex.
6 %
7 % The length of vector X must be an exact power of two.
8 % Twiddle-factors W are computed via
9 % W = fidemo.fi_radix2twiddles(N)
10 % where N = length(X).
11 %
12 % This version of the algorithm has no scaling before the stages.
13 %
14 % See also FI_RADIX2FFT_DEMO.
15
16 % Reference:
17 % Charles Van Loan, Computational
18 % Transform, SIAM, Philadelphia,
19 %
20 % Copyright 2004-2015 The MathWorks
21 %
22 %#codegen
23
24 n = length(x); t = log2(n);
25 x = fidemo.fi_bitreverse(x,n);
26
27 % Generate index variables as in
28 % the loop.
29 LL = int32(2.^(1:t));
30 rr = int32(n./LL);
31 LL2 = int32(LL./2);
32 for q=1:t
33     L = LL(q); r = rr(q); L2 = L

```
- VARIABLE INFO:**
 - Variable: x
 - Size: 128 × 1
 - Class: embedded.fi
 - Complex: Yes
 - NUMERIC TYPE:
 - DataTypeMode: 'Scaled double: binary point scaling'
 - DataType: 'ScaledDouble'
 - Signedness: 'Signed'
 - WordLength: 16
 - FractionLength: 15
 - INSTRUMENTATION RESULTS:
 - Percent of Current Range: 100
 - Always Whole Number: No
 - Sim Min: -0.9998521328458922
 - Sim Max: 0.9988979427807565
- ALL MESSAGES (0) TABLE:**

Name	Type	Size	Class	DT Mode	Signedness	WL	FL	Percent of Current Range	Always Whole Number	Sim Min	Sim Max
x	I/O	128 × 1	complex embedded.fi	ScaledDouble	Signed	16	15	100	No	-0.9998521328458922	0.9988979427807565
w	Input	127 × 1	complex embedded.fi	-	Signed	16	14	51	No	-1	1
n	Local	1 × 1	double	-	-	-	-	-	Yes	128	128
t	Local	1 × 1	double	-	-	-	-	-	Yes	7	7
LL	Local	1 × 7	int32	-	-	-	-	-	Yes	2	128
rr	Local	1 × 7	int32	-	-	-	-	-	Yes	1	64
LL2	Local	1 × 7	int32	-	-	-	-	-	Yes	1	64
temp	Local	1 × 1	complex embedded.fi	ScaledDouble	Signed	33	29	13	No	-0.9998521328458922	0.9988979427807565
L	Local	1 × 1	int32	-	-	-	-	-	Yes	2	128

1 Clear the results log.

```
clearInstrumentationResults testfft_instrumented
```

2 Run a different test bench, then view the new instrumentation results.

```
for i=1:20
    y = testfft_instrumented(cast(rand(size(x))-0.5, 'like', x));
end
```

```
showInstrumentationResults testfft_instrumented
```

```

16 % Reference:
17 %   Charles Van Loan, Computational
18 %   Transform, SIAM, Philadelphia,
19 %
20 % Copyright 2004-2015 The MathWorks
21 %
22 %#codegen
23
24 n = length(x); t = log2(n);
25 x = fidemo.fi_bitreverse(x,n);
26
27 % Generate index variables as in
28 % the loop.
29 LL = int32(2.^(1:t));
30 rr = int32(n./LL);
31 LL2 = int32(LL./2);
32 for q=1:t
33     L = LL(q); r = rr(q); L2 = L

```

VARIABLE INFO

x	
Size:	128 × 1
Class:	embedded.fi
Complex:	Yes
NUMERICTYPE	
DataTypeMode:	'Scaled double: binary point scaling'
DataType:	'ScaledDouble'
Signedness:	'Signed'
WordLength:	16
FractionLength:	15
INSTRUMENTATION RESULTS	
Percent of Current Range:	50
Always Whole Number:	No
Sim Min:	-0.49995165544249043
Sim Max:	0.4998392859913364

LL MESSAGES (0)

- 3 Clear the MEX function and delete temporary files.

```
clear testfft_instrumented;
tempdirObj.cleanUp;
```

See Also

[buildInstrumentedMex](#) | [codegen](#) | [fiaccel](#) | [mex](#) | [showInstrumentationResults](#)

Introduced in R2011b

coder.approximation

Create function replacement configuration object

Syntax

```
q = coder.approximation(function_name)
q = coder.approximation('Function',function_name,Name,Value)
```

Description

`q = coder.approximation(function_name)` creates a function replacement configuration object for use during code generation or fixed-point conversion. The configuration object specifies how to create a lookup table approximation for the MATLAB function specified by `function_name`. To associate this approximation with a `coder.FixptConfig` object for use with the `fiaccel` function, use the `coder.FixptConfig` configuration object `addApproximation` method.

Use this syntax only for the functions that `coder.approximation` can replace automatically. These functions are listed in the `function_name` argument description.

`q = coder.approximation('Function',function_name,Name,Value)` creates a function replacement configuration object using additional options specified by one or more name-value pair arguments.

Examples

Replace Log Function with Default Lookup Table

Create a function replacement configuration object using the default settings. The resulting lookup table in the generated code uses 1000 points.

```
logAppx = coder.approximation('log');
```

Replace Log Function with Uniform Lookup Table

Create a function replacement configuration object. Specify the input range and prefix to add to the replacement function name. The resulting lookup table in the generated code uses 1000 points.

```
logAppx = coder.approximation('Function','log','InputRange',[0.1,1000],...
'FunctionNamePrefix','log_replace');
```

Replace Log Function with Optimized Lookup Table

Create a function replacement configuration object using the `'OptimizeLUTSize'` option to specify to replace the `log` function with an optimized lookup table. The resulting lookup table in the generated code uses less than the default number of points.

```
logAppx = coder.approximation('Function','log','OptimizeLUTSize', true,...
'InputRange',[0.1,1000],'InterpolationDegree',1,'ErrorThreshold',1e-3,...
'FunctionNamePrefix','log_optim_', 'OptimizeIterations',25);
```

Replace Custom Function with Optimized Lookup Table

Create a function replacement configuration object that specifies to replace the custom function, `saturateExp`, with an optimized lookup table.

Create a custom function, `saturateExp`.

```
saturateExp = @(x) 1/(1+exp(-x));
```

Create a function replacement configuration object that specifies to replace the `saturateExp` function with an optimized lookup table. Because the `saturateExp` function is not listed as a function for which `coder.approximation` can generate an approximation automatically, you must specify the `CandidateFunction` property.

```
saturateExp = @(x) 1/(1+exp(-x));
custAppx = coder.approximation('Function','saturateExp',...
'CandidateFunction', saturateExp,...
'NumberOfPoints',50,'InputRange',[0,10]);
```

Input Arguments

function_name — Name of the function to replace

```
'acos' | 'acosd' | 'acosh' | 'acoth' | 'asin' | 'asind' | 'asinh' | 'atan' | 'atand' |
'atanh' | 'cos' | 'cosd' | 'cosh' | 'erf' | 'erfc' | 'exp' | 'log' | 'normcdf' | 'reallog'
| 'realsqrt' | 'reciprocal' | 'rsqrt' | 'sin' | 'sinc' | 'sind' | 'sinh' | 'sqrt' | 'tan' |
'tand'
```

Name of function to replace, specified as a string. The function must be one of the listed functions.

Example: 'sqrt'

Data Types: char

Name-Value Pair Arguments

Specify optional comma-separated pairs of `Name`, `Value` arguments. `Name` is the argument name and `Value` is the corresponding value. `Name` must appear inside quotes. You can specify several name and value pair arguments in any order as `Name1, Value1, ..., NameN, ValueN`.

Example: 'Function', 'log'

Architecture — Architecture of lookup table approximation

```
'LookupTable' (default) | 'Flat'
```

Architecture of the lookup table approximation, specified as the comma-separated pair consisting of 'Architecture' and a string. Use this argument when you want to specify the architecture for the lookup table. The `Flat` architecture does not use interpolation.

Data Types: char

CandidateFunction — Function handle of the replacement function

function handle | string

Function handle of the replacement function, specified as the comma-separated pair consisting of 'CandidateFunction' and a function handle or string referring to a function handle. Use this argument when the function that you want to replace is not listed under `function_name`. Specify the function handle or string referring to a function handle of the function that you want to replace. You can define the function in a file or as an anonymous function.

If you do not specify a candidate function, then the function you chose to replace using the `Function` property is set as the `CandidateFunction`.

Example: 'CandidateFunction', @(x) (1./(1+x))

Data Types: `function_handle` | `char`

ErrorThreshold — Error threshold value used to calculate optimal lookup table size

0.001 (default) | nonnegative scalar

Error threshold value used to calculate optimal lookup table size, specified as the comma-separated pair consisting of 'ErrorThreshold' and a nonnegative scalar. If 'OptimizeLUTSize' is true, this argument is required.

Function — Name of function to replace with a lookup table approximation

function_name

Name of function to replace with a lookup table approximation, specified as the comma-separated pair consisting of 'Function' and a string. The function must be continuous and stateless. If you specify one of the functions that is listed under `function_name`, the conversion process automatically provides a replacement function. Otherwise, you must also specify the 'CandidateFunction' argument for the function that you want to replace.

Example: 'Function','log'

Example: 'Function','my_log','CandidateFunction',@my_log

Data Types: `char`

FunctionNamePrefix — Prefix for generated fixed-point function names

'replacement_' (default) | string

Prefix for generated fixed-point function names, specified as the comma-separated pair consisting of 'FunctionNamePrefix' and a string. The name of a generated function consists of this prefix, followed by the original MATLAB function name.

Example: 'log_replace_'

InputRange — Range over which to replace the function

[] (default) | 2x1 row vector | 2xN matrix

Range over which to replace the function, specified as the comma-separated pair consisting of 'InputRange' and a 2-by-1 row vector or a 2-by-N matrix.

Example: [-1 1]

InterpolationDegree — Interpolation degree

1 (default) | 0 | 2 | 3

Interpolation degree, specified as the comma-separated pair consisting of 'InterpolationDegree' and 1 (linear), 0 (none), 2 (quadratic), or 3 (cubic).

NumberOfPoints — Number of points in lookup table

1000 (default) | positive integer

Number of points in lookup table, specified as the comma-separated pair consisting of 'NumberOfPoints' and a positive integer.

OptimizeIterations — Number of iterations

25 (default) | positive integer

Number of iterations to run when optimizing the size of the lookup table, specified as the comma-separated pair consisting of 'OptimizeIterations' and a positive integer.

OptimizeLUTSize — Optimize lookup table size

false (default) | true

Optimize lookup table size, specified as the comma-separated pair consisting of 'OptimizeLUTSize' and a logical value. Setting this property to true generates an area-optimal lookup table, that is, the lookup table with the minimum possible number of points. This lookup table is optimized for size, but might not be speed efficient.

PipelinedArchitecture — Option to enable pipelining

false (default) | true

Option to enable pipelining, specified as the comma-separated pair consisting of 'PipelinedArchitecture' and a logical value.

Output Arguments

q — Function replacement configuration object, returned as a `coder.mathfcngenerator.LookupTable` or a `coder.mathfcngenerator.Flat` configuration object

`coder.mathfcngenerator.LookupTable` configuration object | `coder.mathfcngenerator.Flat` configuration object

Function replacement configuration object that specifies how to create an approximation for a MATLAB function. Use the `coder.FixptConfig` configuration object `addApproximation` method to associate this configuration object with a `coder.FixptConfig` object. Then use the `fiaccl` function -float2fixed option with `coder.FixptConfig` to convert floating-point MATLAB code to fixed-point MATLAB code.

Property	Default Value
Auto-replace function	''
InputRange	[]
FunctionNamePrefix	'replacement_'
Architecture	LookupTable (read only)
NumberOfPoints	1000
InterpolationDegree	1

Property	Default Value
ErrorThreshold	0.001
OptimizeLUTSize	false
OptimizeIterations	25

See Also

Classes

`coder.FixPtConfig`

Functions

`fiaccel`

Topics

“Replace the exp Function with a Lookup Table”

“Replace a Custom Function with a Lookup Table”

“Replacing Functions Using Lookup Table Approximations”

Introduced in R2014b

coder.allowpcode

Package: coder

Control code generation from protected MATLAB files

Syntax

```
coder.allowpcode('plain')
```

Description

`coder.allowpcode('plain')` allows you to generate protected MATLAB code (P-code) that you can then compile into optimized MEX functions or embeddable C/C++ code. This function does not obfuscate the generated MEX functions or embeddable C/C++ code.

With this capability, you can distribute algorithms as protected P-files that provide code generation optimizations.

Call this function in the top-level function before control-flow statements, such as `if`, `while`, `switch`, and function calls.

MATLAB functions can call P-code. When the `.m` and `.p` versions of a file exist in the same folder, the P-file takes precedence.

`coder.allowpcode` is ignored outside of code generation.

Examples

Generate optimized embeddable code from protected MATLAB code:

- 1 Write an function `p_abs` that returns the absolute value of its input:

```
function out = p_abs(in)    %#codegen
% The directive %#codegen indicates that the function
% is intended for code generation
coder.allowpcode('plain');
out = abs(in);
```

- 2 Generate protected P-code. At the MATLAB prompt, enter:

```
pcode p_abs
```

The P-file, `p_abs.p`, appears in the current folder.

- 3 Generate a MEX function for `p_abs.p`, using the `-args` option to specify the size, class, and complexity of the input parameter (requires a MATLAB Coder license). At the MATLAB prompt, enter:

```
codegen p_abs -args { int32(0) }
```

`codegen` generates a MEX function in the current folder.

- 4 Generate embeddable C code for `p_abs.p` (requires a MATLAB Coder license). At the MATLAB prompt, enter:

```
codegen p_abs -config:lib -args { int32(0) };
```

codegen generates C library code in the `codegen\lib\p_abs` folder.

See Also

codegen | pcode

Introduced in R2011a

coder.ArrayType class

Package: coder

Superclasses: coder.Type

Represent set of MATLAB arrays

Description

Specifies the set of arrays that the generated code accepts. Use only with the `fiaccl -args` option. Do not pass as an input to a generated MEX function.

Construction

Note You can also create and edit `coder.Type` objects interactively by using the `Coder Type Editor`. See “Create and Edit Input Types by Using the `Coder Type Editor`”.

`coder.ArrayType` is an abstract class. You cannot create instances of it directly. You can create `coder.EnumType`, `coder.FiType`, `coder.PrimitiveType`, and `coder.StructType` objects that derive from this class.

Properties

ClassName

Class of values in this set

SizeVector

The upper-bound size of arrays in this set.

VariableDims

A vector specifying whether each dimension of the array is fixed or variable size. If a vector element is `true`, the corresponding dimension is variable size.

Copy Semantics

Value. To learn how value classes affect copy operations, see `Copying Objects`.

See Also

`coder.CellType` | `coder.ClassType` | `coder.EnumType` | `coder.FiType` | `coder.PrimitiveType` | `coder.StructType` | `coder.Type` | `coder.newtype` | `coder.resize` | `coder.typeof` | `fiaccl`

Topics

“Create and Edit Input Types by Using the `Coder Type Editor`”

Introduced in R2011a

coder.config

Create configuration object for fixed-point or single-precision conversion

Syntax

```
config_obj = coder.config('fixpt')  
config_obj = coder.config('single')
```

Description

`config_obj = coder.config('fixpt')` creates a `coder.FixptConfig` configuration object. Use this object with the `fiaccel` function when converting floating-point MATLAB code to fixed-point MATLAB code.

`config_obj = coder.config('single')` creates a `coder.SingleConfig` configuration object for use with the `convertToSingle` function when generating single-precision MATLAB code from double-precision MATLAB code.

Examples

Convert Floating-Point MATLAB Code to Fixed-Point MATLAB Code

Create a `coder.FixptConfig` object, `fixptcfg`, with default settings.

```
fixptcfg = coder.config('fixpt');
```

Set the test bench name. In this example, the test bench function name is `dti_test`.

```
fixptcfg.TestBenchName = 'dti_test';
```

Convert your floating-point MATLAB design to fixed point. In this example, the MATLAB function name is `dti`.

```
fiaccel -float2fixed fixptcfg dti
```

Convert Double-Precision MATLAB Code to Single-Precision MATLAB Code

Create a `coder.SingleConfig` object, `scfg`.

```
scfg = coder.config('single');
```

Set the test bench name. In this example, the test bench function name is `myfun_test`. Enable numerics testing and data logging for comparison plotting of input and output variables.

```
scfg.TestBenchName = 'myfun_test';  
scfg.TestNumerics = true;  
scfg.LogIOForComparisonPlotting = true;
```

Convert the double-precision MATLAB code to single-precision MATLAB code. In this example, the MATLAB function name is `myfun`.

```
convertToSingle -config scfg myfun
```

See Also

[coder.FixPtConfig](#) | [coder.SingleConfig](#) | [convertToSingle](#) | [fiaccel](#)

Introduced in R2014b

coder.const

Fold expressions into constants in generated code

Syntax

```
out = coder.const(expression)
[out1,...,outN] = coder.const(handle, arg1,..., argN)
```

Description

`out = coder.const(expression)` evaluates `expression` and replaces `out` with the result of the evaluation in generated code.

`[out1,...,outN] = coder.const(handle, arg1,..., argN)` evaluates the multi-output function having handle `handle`. It then replaces `out1,...,outN` with the results of the evaluation in the generated code.

Examples

Specify Constants in Generated Code

This example shows how to specify constants in generated code using `coder.const`.

Write a function `AddShift` that takes an input `Shift` and adds it to the elements of a vector. The vector consists of the square of the first 10 natural numbers. `AddShift` generates this vector.

```
function y = AddShift(Shift) %#codegen
y = (1:10).^2+Shift;
```

Generate code for `AddShift` using the `codegen` command. Open the Code Generation Report.

```
codegen -config:lib -launchreport AddShift -args 0
```

The code generator produces code for creating the vector. It adds `Shift` to each element of the vector during vector creation. The definition of `AddShift` in generated code looks as follows:

```
void AddShift(double Shift, double y[10])
{
    int k;
    for (k = 0; k < 10; k++) {
        y[k] = (double)((1 + k) * (1 + k)) + Shift;
    }
}
```

Replace the expression `(1:10).^2` with `coder.const((1:10).^2)`, and then generate code for `AddShift` again using the `codegen` command. Open the Code Generation Report.

```
codegen -config:lib -launchreport AddShift -args 0
```

The code generator creates the vector containing the squares of the first 10 natural numbers. In the generated code, it adds `Shift` to each element of this vector. The definition of `AddShift` in generated code looks as follows:

```
void AddShift(double Shift, double y[10])
{
    int i;
    static const signed char iv[10] = { 1, 4, 9, 16, 25, 36,
                                        49, 64, 81, 100 };

    for (i = 0; i < 10; i++) {
        y[i] = (double)iv[i] + Shift;
    }
}
```

Create Lookup Table in Generated Code

This example shows how to fold a user-written function into a constant in generated code.

Write a function `getsine` that takes an input `index` and returns the element referred to by `index` from a lookup table of sines. The function `getsine` creates the lookup table using another function `gettable`.

```
function y = getsine(index) %#codegen
    assert(isa(index, 'int32'));
    persistent tbl;
    if isempty(tbl)
        tbl = gettable(1024);
    end
    y = tbl(index);

function y = gettable(n)
    y = zeros(1,n);
    for i = 1:n
        y(i) = sin((i-1)/(2*pi*n));
    end
```

Generate code for `getsine` using an argument of type `int32`. Open the Code Generation Report.

```
codegen -config:lib -launchreport getsine -args int32(0)
```

The generated code contains instructions for creating the lookup table.

Replace the statement:

```
tbl = gettable(1024);
```

with:

```
tbl = coder.const(gettable(1024));
```

Generate code for `getsine` using an argument of type `int32`. Open the Code Generation Report.

The generated code contains the lookup table itself. `coder.const` forces the expression `gettable(1024)` to be evaluated during code generation. The generated code does not contain instructions for the evaluation. The generated code contains the result of the evaluation itself.

Specify Constants in Generated Code Using Multi-Output Function

This example shows how to specify constants in generated code using a multi-output function in a `coder.const` statement.

Write a function `MultiplyConst` that takes an input `factor` and multiplies every element of two vectors `vec1` and `vec2` with `factor`. The function generates `vec1` and `vec2` using another function `EvalConsts`.

```
function [y1,y2] = MultiplyConst(factor) %#codegen
    [vec1,vec2]=EvalConsts(pi.*(1./2.^(1:10)),2);
    y1=vec1.*factor;
    y2=vec2.*factor;

function [f1,f2]=EvalConsts(z,n)
    f1=z.^(2*n)/factorial(2*n);
    f2=z.^(2*n+1)/factorial(2*n+1);
```

Generate code for `MultiplyConst` using the `codegen` command. Open the Code Generation Report.

```
codegen -config:lib -launchreport MultiplyConst -args 0
```

The code generator produces code for creating the vectors.

Replace the statement

```
[vec1,vec2]=EvalConsts(pi.*(1./2.^(1:10)),2);
```

with

```
[vec1,vec2]=coder.const(@EvalConsts,pi.*(1./2.^(1:10)),2);
```

Generate code for `MultiplyConst` using the `codegen` command. Open the Code Generation Report.

```
codegen -config:lib -launchreport MultiplyConst -args 0
```

The code generator does not generate code for creating the vectors. Instead, it calculates the vectors and specifies the calculated vectors in generated code.

Read Constants by Processing XML File

This example shows how to call an extrinsic function using `coder.const`.

Write an XML file `MyParams.xml` containing the following statements:

```
<params>
  <param name="hello" value="17"/>
  <param name="world" value="42"/>
</params>
```

Save `MyParams.xml` in the current folder.

Write a MATLAB function `xml2struct` that reads an XML file. The function identifies the XML tag `param` inside another tag `params`.

After identifying `param`, the function assigns the value of its attribute `name` to the field name of a structure `s`. The function also assigns the value of attribute `value` to the value of the field.

```
function s = xml2struct(file)

s = struct();
doc = xmlread(file);
els = doc.getElementsByTagName('params');
for i = 0:els.getLength-1
    it = els.item(i);
    ps = it.getElementsByTagName('param');
    for j = 0:ps.getLength-1
        param = ps.item(j);
        paramName = char(param.getAttribute('name'));
        paramValue = char(param.getAttribute('value'));
        paramValue = evalin('base', paramValue);
        s.(paramName) = paramValue;
    end
end
```

Save `xml2struct` in the current folder.

Write a MATLAB function `MyFunc` that reads the XML file `MyParams.xml` into a structure `s` using the function `xml2struct`. Declare `xml2struct` as extrinsic using `coder.extrinsic` and call it in a `coder.const` statement.

```
function y = MyFunc(u) %#codegen
    assert(isa(u, 'double'));
    coder.extrinsic('xml2struct');
    s = coder.const(xml2struct('MyParams.xml'));
    y = s.hello + s.world + u;
```

Generate code for `MyFunc` using the `codegen` command. Open the Code Generation Report.

```
codegen -config:dll -launchreport MyFunc -args 0
```

The code generator executes the call to `xml2struct` during code generation. It replaces the structure fields `s.hello` and `s.world` with the values 17 and 42 in generated code.

Input Arguments

expression — MATLAB expression or user-written function

expression with constants | single-output function with constant arguments

MATLAB expression or user-defined single-output function.

The expression must have compile-time constants only. The function must take constant arguments only. For instance, the following code leads to a code generation error, because `x` is not a compile-time constant.

```
function y=func(x)
    y=coder.const(log10(x));
```

To fix the error, assign `x` to a constant in the MATLAB code. Alternatively, during code generation, you can use `coder.Constant` to define input type as follows:

```
codegen -config:lib func -args coder.Constant(10)
```

Example: `2*pi, factorial(10)`

handle — Function handle

function handle

Handle to built-in or user-written function.

Example: `@log, @sin`

Data Types: `function_handle`

arg1, ..., argN — Arguments to the function with handle handle

function arguments that are constants

Arguments to the function with handle `handle`.

The arguments must be compile-time constants. For instance, the following code leads to a code generation error, because `x` and `y` are not compile-time constants.

```
function y=func(x,y)
    y=coder.const(@choosek,x,y);
```

To fix the error, assign `x` and `y` to constants in the MATLAB code. Alternatively, during code generation, you can use `coder.Constant` to define input type as follows:

```
codegen -config:lib func -args {coder.Constant(10),coder.Constant(2)}
```

Output Arguments

out — Value of expression

value of the evaluated expression

Value of expression. In the generated code, MATLAB Coder replaces occurrences of `out` with the value of expression.

out1, ..., outN — Outputs of the function with handle handle

values of the outputs of the function with handle `handle`

Outputs of the function with handle `handle`. MATLAB Coder evaluates the function and replaces occurrences of `out1, ..., outN` with constants in the generated code.

Tips

- When possible, the code generator constant-folds expressions automatically. Typically, automatic constant-folding occurs for expressions with scalars only. Use `coder.const` when the code generator does not constant-fold expressions on its own.
- When constant-folding computationally intensive function calls, to reduce code generation time, make the function call extrinsic. The extrinsic function call causes evaluation of the function call by MATLAB instead of by the code generator. For example:

```
function j = fcn(z)
zTable = coder.const(0:0.01:100);
jTable = coder.const(feval('besselj',3,zTable));
j = interp1(zTable,jTable,z);
end
```

See “Use coder.const with Extrinsic Function Calls” (MATLAB Coder).

- If `coder.const` is unable to constant-fold a function call, try to force constant-folding by making the function call extrinsic. The extrinsic function call causes evaluation of the function call by MATLAB instead of by the code generator. For example:

```
function yi = fcn(xi)
y = coder.const(feval('rand',1,100));
yi = interp1(y,xi);
end
```

See “Use coder.const with Extrinsic Function Calls” (MATLAB Coder).

See Also

Topics

“Fold Function Calls into Constants” (MATLAB Coder)

“Use coder.const with Extrinsic Function Calls” (MATLAB Coder)

Introduced in R2013b

coder.Constant class

Package: coder

Superclasses: coder.Type

Specification of constant value for code generation

Description

Use a `coder.Constant` object to define input values that are constant during code generation. Use this object with the `fiaccl -args` and `-globals` options to specify the properties of the input arguments and the global variables, respectively. Do not pass it as an input to a generated MEX function.

You can use a `coder.Constant` object in place of a `coder.Type` object to specify a given constant value in an entry-point input or global variable.

Creation

`const_type = coder.Constant(v)` creates a `coder.Constant` type from the value `v`.

`const_type = coder.newtype('constant', v)` creates a `coder.Constant` type from the value `v`.

Note After you have created a `coder.Constant` object, you can create a constant global variable `g` that has the value `v` by using the `codegen` command: `codegen -globals {'g'}, coder.Constant(v)`.

Properties

Value — Actual value of constant

`constant`

The actual value of the constant. Also indicates the input argument value `v` that is used to construct the input argument type.

Here, in the first example, when `k` is passed in `codegen` with value `v` as 42, the corresponding input type is inferred as `double`. Similarly, in the second example, when `k` is passed in `codegen` with value `v` as 42, the corresponding input type is inferred as `uint8`.

Example: `k = coder.Constant(42);`

Example: `k = coder.Constant(uint8(42));`

Examples

Create a Constant with Value 42

```
k = coder.Constant(42);
```

Create a new constant type for use in code generation

```
k = coder.newtype('constant', 42);
```

Limitations

- You cannot use `coder.Constant` on sparse matrices, or on structures, cell arrays, or classes that contain sparse matrices.

See Also

`coder.Constant` | `coder.Type` | `coder.newtype` | `fiaccel`

Introduced in R2011a

coder.EnumType class

Package: coder

Superclasses: coder.ArrayType

Represent set of MATLAB enumerations

Description

Specifies the set of MATLAB enumerations that the generated code should accept. Use only with the `fiaccel -args` options. Do not pass as an input to a generated MEX function.

Construction

Note You can also create and edit `coder.Type` objects interactively by using the Coder Type Editor. See “Create and Edit Input Types by Using the Coder Type Editor”.

`enum_type = coder.typeof(enum_value)` creates a `coder.EnumType` object representing a set of enumeration values of class (`enum_value`).

`enum_type = coder.typeof(enum_value, sz, variable_dims)` returns a modified copy of `coder.typeof(enum_value)` with (upper bound) size specified by `sz` and variable dimensions `variable_dims`. If `sz` specifies `inf` for a dimension, then the size of the dimension is unbounded and the dimension is variable size. When `sz` is `[]`, the (upper bound) sizes of `v` do not change. If you do not specify `variable_dims`, the bounded dimensions of the type are fixed; the unbounded dimensions are variable size. When `variable_dims` is a scalar, it applies to bounded dimensions that are not 1 or 0 (which are fixed).

`enum_type = coder.newtype(enum_name, sz, variable_dims)` creates a `coder.EnumType` object that has variable size with (upper bound) sizes `sz` and variable dimensions `variable_dims`. If `sz` specifies `inf` for a dimension, then the size of the dimension is unbounded and the dimension is variable size. If you do not specify `variable_dims`, the bounded dimensions of the type are fixed. When `variable_dims` is a scalar, it applies to bounded dimensions that are not 1 or 0 (which are fixed).

Input Arguments

enum_value

Enumeration value defined in a file on the MATLAB path.

sz

Size vector specifying each dimension of type object.

Default: [1 1] for `coder.newtype`

variable_dims

Logical vector that specifies whether each dimension is variable size (true) or fixed size (false).

Default: `false(size(sz)) | sz==Inf` for `coder.newtype`

enum_name

Name of enumeration defined in a file on the MATLAB path.

Properties

ClassName

Class of values in the set.

SizeVector

The upper-bound size of arrays in the set.

VariableDims

A vector specifying whether each dimension of the array is fixed or variable size. If a vector element is `true`, the corresponding dimension is variable size.

Copy Semantics

Value. To learn how value classes affect copy operations, see [Copying Objects](#).

Examples

Create a `coder.EnumType` object using a value from an existing MATLAB enumeration.

- 1 Define an enumeration `MyColors`. On the MATLAB path, create a file named 'MyColors' containing:

```
classdef MyColors < int32
    enumeration
        green(1),
        red(2),
    end
end
```

- 2 Create a `coder.EnumType` object from this enumeration.

```
t = coder.typeof(MyColors.red);
```

Create a `coder.EnumType` object using the name of an existing MATLAB enumeration.

- 1 Define an enumeration `MyColors`. On the MATLAB path, create a file named 'MyColors' containing:

```
classdef MyColors < int32
    enumeration
        green(1),
        red(2),
    end
end
```

- 2 Create a `coder.EnumType` object from this enumeration.

```
t = coder.newtype('MyColors');
```

See Also

[coder.ArrayType](#) | [coder.ClassType](#) | [coder.Type](#) | [coder.newtype](#) | [coder.resize](#) | [coder.typeof](#) | [fiaccl](#)

Topics

[“Enumerations”](#)

[“Create and Edit Input Types by Using the Coder Type Editor”](#)

Introduced in R2011a

`coder.extrinsic`

Declare a function as extrinsic and execute it in MATLAB

Syntax

```
coder.extrinsic(function)
coder.extrinsic(function1, ... ,functionN)

coder.extrinsic('-sync:on', function1, ... ,functionN)
coder.extrinsic('-sync:off', function1, ... ,functionN)
```

Description

`coder.extrinsic(function)` declares `function` as an extrinsic function. The code generator does not produce code for the body of the extrinsic function and instead uses the MATLAB engine to execute the call. This functionality is available only when the MATLAB engine is available during execution. Examples of situations during which the MATLAB engine is available include execution of MEX functions, Simulink simulations, or function calls at the time of code generation (also known as compile time).

During standalone code generation, the code generator attempts to determine whether an extrinsic function affects the output of the function in which it is called — for example by returning `mxArrays` to an output variable. Provided that there is no change to the output, the code generator proceeds with code generation, but excludes the extrinsic function from the generated code. Otherwise, the code generator produces a compilation error.

You cannot use `coder.ceval` on functions that you declare as extrinsic by using `coder.extrinsic`.

`coder.extrinsic` is ignored outside of code generation.

Note The code generator automatically treats many common MATLAB visualization functions, such as `plot`, `disp`, and `figure`, as extrinsic. You do not have to explicitly declare them as extrinsic functions by using `coder.extrinsic`.

`coder.extrinsic(function1, ... ,functionN)` declares `function1` through `functionN` as extrinsic functions.

`coder.extrinsic('-sync:on', function1, ... ,functionN)` enables synchronization of global data between MATLAB execution and generated code execution or Simulink simulation before and after calls to the extrinsic functions `function1` through `functionN`. If only a few extrinsic calls use or modify global data, turn off synchronization before and after all extrinsic function calls by setting the global synchronization mode to `At MEX-function entry and exit`. Use the `'-sync:on'` option to turn on synchronization for only the extrinsic calls that do modify global data.

See “Generate Code for Global Data” (MATLAB Coder).

`coder.extrinsic('-sync:off', function1, ... ,functionN)` disables synchronization of global data between MATLAB execution and generated code execution before and after calls to the

extrinsic functions `function1` through `functionN`. If most extrinsic calls use or modify global data, but a few do not, use the `'-sync:off'` option to turn off synchronization for the extrinsic calls that do not modify global data.

See “Generate Code for Global Data” (MATLAB Coder).

Examples

Declare a MATLAB Visualization Function as Extrinsic

The MATLAB function `patch` is not supported for code generation. This example shows how you can still use the functionality of `patch` in your generated MEX function by declaring `patch` as extrinsic your MATLAB function.

This MATLAB code declares `patch` as extrinsic in the local function `create_plot`. By declaring `patch` as extrinsic, you instruct the code generator not to produce code for `patch`. Instead, the code generator dispatches `patch` to MATLAB for execution.

The code generator automatically treats many common MATLAB visualization functions, such as the function `axis` as extrinsic.

```
function c = pythagoras(a,b,color) %#codegen
% Calculate the hypotenuse of a right triangle
% and display the triangle as a patch object.
c = sqrt(a^2 + b^2);
create_plot(a, b, color);
end

function create_plot(a, b, color)
%Declare patch as extrinsic
coder.extrinsic('patch');
x = [0;a;a];
y = [0;0;b];
patch(x,y,color);
axis('equal');
end
```

Generate a MEX function for `pythagoras`. Also, generate the code generation report.

```
codegen -report pythagoras -args {1, 1, [.3 .3 .3]}
```

In the report, view the MATLAB code for `create_plot`.

```
7 function create_plot(a, b, color)
8 coder.extrinsic('patch');
9 x = [0;a;a];
10 y = [0;0;b];
11 patch(x,y,color);
12 axis('equal');
13 end
```

The report highlights the `patch` and `axis` functions to indicate that they are treated as extrinsic functions.

Run the MEX function.

```
pythagoras_mex(3, 4, [1.0 0.0 0.0]);
```

MATLAB displays the plot of the right triangle as a red patch object.

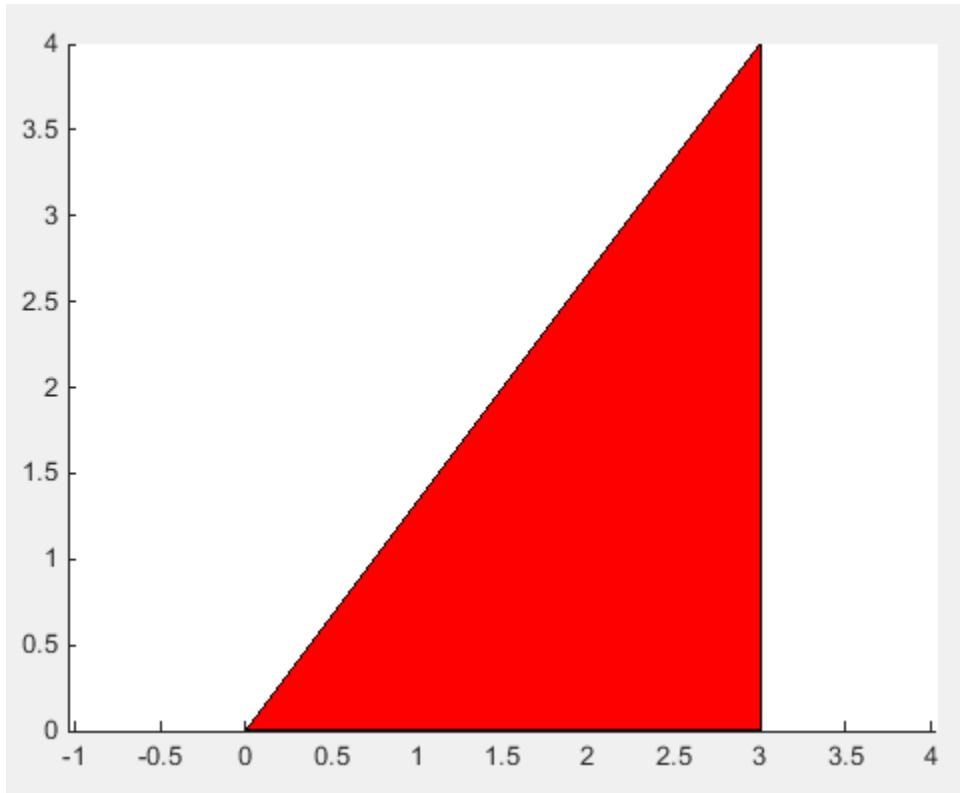

Note Instead of generating a MEX file by using the `codegen` command, you could also place the function `pythagoras` inside a MATLAB Function block in a Simulink model. When you simulate the model, the MATLAB Function block has similar behavior as `pythagoras_mex`.

Declare MATLAB Graph Functions as Extrinsic

The MATLAB functions for graph and network algorithms are not supported for code generation. This example shows how you can still use these functions in your generated MEX code by declaring them as extrinsic.

Define a MATLAB function `foo` that accepts source and target node indices for a directed graph as inputs and determines if the graph is acyclic. The function `foo` also plots the directed graph.

The function `foo` calls these functions that are not supported for code generation:

- `plot`: The code generator automatically treats this function as extrinsic.
- `digraph` and `isdag`: These two functions are explicitly declared to be extrinsic by using the `coder.extrinsic` construct.

```
function isDAG = foo(source,target)
coder.extrinsic('digraph','isdag');
assert(numel(source) == numel(target))
G = digraph(source,target);
plot(G)
isDAG = isdag(G);
end
```

Generate MEX code for foo. Specify the inputs to be unbounded vectors of type double.

```
codegen foo -args {coder.typeof(0,Inf),coder.typeof(0,Inf)}
```

Call the generated MEX function foo_mex with suitable inputs:

```
foo_mex([1 2 4 4],[2 3 3 1])
```

```
ans =
```

```
logical
```

```
1
```

MATLAB also displays the graph:

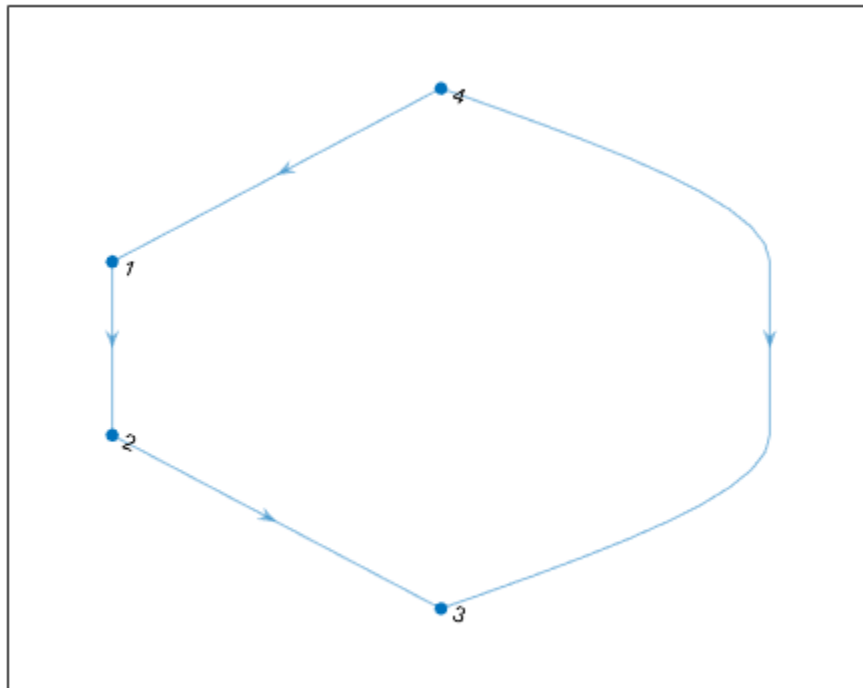

Input Arguments

function — MATLAB function name
character vector

Name of the MATLAB function that is declared as extrinsic.

Example: `coder.extrinsic('patch')`

Data Types: `char`

Limitations

- Extrinsic function calls have some overhead that can affect performance. Input data that is passed in an extrinsic function call must be provided to MATLAB, which requires making a copy of the data. If the function has any output data, this data must be transferred back into the MEX function environment, which also requires a copy.
- The code generator does not support the use of `coder.extrinsic` to call functions that are located in a private folder.
- The code generator does not support the use of `coder.extrinsic` to call local functions.

Tips

- The code generator automatically treats many common MATLAB visualization functions, such as `plot`, `disp`, and `figure`, as extrinsic. You do not have to explicitly declare them as extrinsic functions by using `coder.extrinsic`.
- Use the `coder.screener` function to detect which functions you must declare as extrinsic. This function runs the Code Generation Readiness Tool that screens the MATLAB code for features and functions that are not supported for code generation.

See Also

`coder.screener`

Topics

“Use MATLAB Engine to Execute a Function Call in Generated Code”

“Generate Code for Global Data” (MATLAB Coder)

“Resolution of Function Calls for Code Generation”

Introduced in R2011a

coder.FiType class

Package: coder

Superclasses: coder.ArrayType

Represent set of MATLAB fixed-point arrays

Description

Specifies the set of fixed-point array values that the generated code should accept. Use only with the `fiaccel -args` options. Do not pass as an input to the generated MEX function.

Construction

Note You can also create and edit `coder.Type` objects interactively by using the `Coder Type Editor`. See “Create and Edit Input Types by Using the Coder Type Editor”.

`t=coder.typeof(v)` creates a `coder.FiType` object representing a set of fixed-point values whose properties are based on the fixed-point input `v`.

`t=coder.typeof(v, sz, variable_dims)` returns a modified copy of `coder.typeof(v)` with (upper bound) size specified by `sz` and variable dimensions `variable_dims`. If `sz` specifies `inf` for a dimension, then the size of the dimension is unbounded and the dimension is variable size. When `sz` is `[]`, the (upper bound) sizes of `v` do not change. If you do not specify the `variable_dims` input parameter, the bounded dimensions of the type are fixed. When `variable_dims` is a scalar, it applies to the bounded dimensions that are not 1 or 0 (which are fixed).

`t=coder.newtype('embedded.fi', numerictype, sz, variable_dims)` creates a `coder.Type` object representing a set of fixed-point values with `numerictype` and (upper bound) sizes `sz` and variable dimensions `variable_dims`. If `sz` specifies `inf` for a dimension, then the size of the dimension is unbounded and the dimension is variable size. When you do not specify `variable_dims`, the bounded dimensions of the type are fixed. When `variable_dims` is a scalar, it applies to the bounded dimensions that are not 1 or 0 (which are fixed).

`t=coder.newtype('embedded.fi', numerictype, sz, variable_dims, Name, Value)` creates a `coder.Type` object representing a set of fixed-point values with `numerictype` and additional options specified by one or more `Name, Value` pair arguments. `Name` can also be a property name and `Value` is the corresponding value. Specify `Name` as a character vector or string scalar. You can specify several name-value pair arguments in any order as `Name1, Value1, ..., NameN, ValueN`.

Input Arguments

v

Fixed-point value used to create new `coder.FiType` object.

sz

Size vector specifying each dimension of type object.

Default: [1 1] for `coder.newtype`

variable_dims

Logical vector that specifies whether each dimension is variable size (`true`) or fixed size (`false`).

Default: `false(size(sz)) | sz == Inf` for `coder.newtype`

Name-Value Pair Arguments

Specify optional comma-separated pairs of `Name, Value` arguments. `Name` is the argument name and `Value` is the corresponding value. `Name` must appear inside quotes. You can specify several name and value pair arguments in any order as `Name1, Value1, ..., NameN, ValueN`.

complex

Set `complex` to `true` to create a `coder.Type` object that can represent complex values. The type must support complex data.

Default: `false`

fimath

Specify local `fimath`. If not, uses default `fimath`.

Properties

ClassName

Class of values in the set.

Complex

Indicates whether fixed-point arrays in the set are real (`false`) or complex (`true`).

Fimath

Local `fimath` that the fixed-point arrays in the set use.

NumericType

`numericType` that the fixed-point arrays in the set use.

SizeVector

The upper-bound size of arrays in the set.

VariableDims

A vector specifying whether each dimension of the array is fixed or variable size. If a vector element is `true`, the corresponding dimension is variable size.

Copy Semantics

Value. To learn how value classes affect copy operations, see [Copying Objects](#).

Examples

Create a new fixed-point type `t`.

```
t = coder.typeof(fi(1));
% Returns
% coder.FiType
% 1x1 embedded.fi
%     DataTypeMode:Fixed-point: binary point scaling
%     Signedness:Signed
%     WordLength:16
%     FractionLength:14
```

Create a new fixed-point type for use in code generation. The fixed-point type uses the default `fimath`.

```
t = coder.newtype('embedded.fi',numerictype(1, 16, 15), [1 2])

t =
% Returns
% coder.FiType
% 1x2 embedded.fi
%     DataTypeMode: Fixed-point: binary point scaling
%     Signedness: Signed
%     WordLength: 16
%     FractionLength: 15
```

This new type uses the default `fimath`.

See Also

[coder.ArrayType](#) | [coder.ClassType](#) | [coder.Type](#) | [coder.newtype](#) | [coder.resize](#) | [coder.typeof](#) | [fiaccel](#)

Topics

“Create and Edit Input Types by Using the Coder Type Editor”

Introduced in R2011a

coder.FixPtConfig class

Package: coder

Floating-point to fixed-point conversion configuration object

Description

A `coder.FixPtConfig` object contains the configuration parameters that the `fiaccel` function requires to convert floating-point MATLAB code to fixed-point MATLAB code. Use the `-float2fixed` option to pass this object to the `fiaccel` function.

Construction

`fixptcfg = coder.config('fixpt')` creates a `coder.FixPtConfig` object for floating-point to fixed-point conversion.

Properties

ComputeDerivedRanges

Enable derived range analysis.

Values: `true|false` (default)

ComputeSimulationRanges

Enable collection and reporting of simulation range data. If you need to run a long simulation to cover the complete dynamic range of your design, consider disabling simulation range collection and running derived range analysis instead.

Values: `true` (default)|`false`

DefaultFractionLength

Default fixed-point fraction length.

Values: 4 (default) | positive integer

DefaultSignedness

Default signedness of variables in the generated code.

Values: 'Automatic' (default) | 'Signed' | 'Unsigned'

DefaultWordLength

Default fixed-point word length.

Values: 14 (default) | positive integer

DetectFixptOverflows

Enable detection of overflows using scaled doubles.

Values: true| false (default)

fimath

fimath properties to use for conversion.

Values: fimath('RoundingMethod', 'Floor', 'OverflowAction', 'Wrap', 'ProductMode', 'FullPrecision', 'SumMode', 'FullPrecision') (default) | string

FixPtFileNameSuffix

Suffix for fixed-point file names.

Values: '_fixpt' | string

LaunchNumericTypesReport

View the numeric types report after the software has proposed fixed-point types.

Values: true (default) | false

LogIOForComparisonPlotting

Enable simulation data logging to plot the data differences introduced by fixed-point conversion.

Values: true (default) | false

OptimizeWholeNumber

Optimize the word lengths of variables whose simulation min/max logs indicate that they are always whole numbers.

Values: true (default) | false

PlotFunction

Name of function to use for comparison plots.

LogIOForComparisonPlotting must be set to true to enable comparison plotting. This option takes precedence over PlotWithSimulationDataInspector.

The plot function should accept three inputs:

- A structure that holds the name of the variable and the function that uses it.
- A cell array to hold the logged floating-point values for the variable.
- A cell array to hold the logged values for the variable after fixed-point conversion.

Values: '' (default) | string

PlotWithSimulationDataInspector

Use Simulation Data Inspector for comparison plots.

`LogIOForComparisonPlotting` must be set to true to enable comparison plotting. The `PlotFunction` option takes precedence over `PlotWithSimulationDataInspector`.

Values: true| false (default)

ProposeFractionLengthsForDefaultWordLength

Propose fixed-point types based on `DefaultWordLength`.

Values: true (default) | false

ProposeTargetContainerTypes

By default (false), propose data types with the minimum word length needed to represent the value. When set to true, propose data type with the smallest word length that can represent the range and is suitable for C code generation (8,16,32, 64 ...). For example, for a variable with range [0..7], propose a word length of 8 rather than 3.

Values: true| false (default)

ProposeWordLengthsForDefaultFractionLength

Propose fixed-point types based on `DefaultFractionLength`.

Values: false (default) | true

ProposeTypesUsing

Propose data types based on simulation range data, derived ranges, or both.

Values: 'BothSimulationAndDerivedRanges' (default) |
'SimulationRanges'|'DerivedRanges'

SafetyMargin

Safety margin percentage by which to increase the simulation range when proposing fixed-point types. The specified safety margin must be a real number greater than -100.

Values: 0 (default) | double

StaticAnalysisQuickMode

Perform faster static analysis.

Values: true | false (default)

StaticAnalysisTimeoutMinutes

Abort analysis if timeout is reached.

Values: '' (default) | positive integer

TestBenchName

Test bench function name or names, specified as a string or cell array of strings. You must specify at least one test bench.

If you do not explicitly specify input parameter data types, the conversion uses the first test bench function to infer these data types.

Values: '' (default) | string | cell array of strings

TestNumerics

Enable numerics testing.

Values: true| false (default)

Methods

addApproximation	Replace floating-point function with lookup table during fixed-point conversion
addDesignRangeSpecification	Add design range specification to parameter
addFunctionReplacement	Replace floating-point function with fixed-point function during fixed-point conversion
clearDesignRangeSpecifications	Clear all design range specifications
getDesignRangeSpecification	Get design range specifications for parameter
hasDesignRangeSpecification	Determine whether parameter has design range
removeDesignRangeSpecification	Remove design range specification from parameter

Examples

Convert Floating-Point MATLAB Code to Fixed Point Based On Simulation Ranges

Create a `coder.FixPtConfig` object, `fixptcfg`, with default settings.

```
fixptcfg = coder.config('fixpt');
```

Set the test bench name. In this example, the test bench function name is `dti_test`. The conversion process uses the test bench to infer input data types and collect simulation range data.

```
fixptcfg.TestBenchName = 'dti_test';
```

Select to propose data types based on simulation ranges only. By default, proposed types are based on both simulation and derived ranges.

```
fixptcfg.ProposeTypesUsing = 'SimulationRanges';
```

Convert a floating-point MATLAB function to fixed-point MATLAB code. In this example, the MATLAB function name is `dti`.

```
fiaccel -float2fixed fixptcfg dti
```

Convert Floating-Point MATLAB Code to Fixed Point Based On Simulation and Derived Ranges

Create a `coder.FixPtConfig` object, `fixptcfg`, with default settings.

```
fixptcfg = coder.config('fixpt');
```

Set the name of the test bench to use to infer input data types. In this example, the test bench function name is `dti_test`. The conversion process uses the test bench to infer input data types.

```
fixptcfg.TestBenchName = 'dti_test';
```

Select to propose data types based on derived ranges.

```
fixptcfg.ProposeTypesUsing = 'DerivedRanges';
fixptcfg.ComputeDerivedRanges = true;
```

Add design ranges. In this example, the `dti` function has one scalar double input, `u_in`. Set the design minimum value for `u_in` to -1 and the design maximum to 1.

```
fixptcfg.addDesignRangeSpecification('dti', 'u_in', -1.0, 1.0);
```

Convert the floating-point MATLAB function, `dti`, to fixed-point MATLAB code.

```
fiaccel -float2fixed fixptcfg dti
```

Enable Overflow Detection

When you select to detect potential overflows, `fiaccel` generates a scaled double version of the generated fixed-point MEX function. Scaled doubles store their data in double-precision floating-point, so they carry out arithmetic in full range. They also retain their fixed-point settings, so they are able to report when a computation goes out of the range of the fixed-point type.

Create a `coder.FixPtConfig` object, `fixptcfg`, with default settings.

```
fixptcfg = coder.config('fixpt');
```

Set the test bench name. In this example, the test bench function name is `dti_test`.

```
fixptcfg.TestBenchName = 'dti_test';
```

Enable numerics testing with overflow detection.

```
fixptcfg.TestNumerics = true;
fixptcfg.DetectFixptOverflows = true;
```

Convert a floating-point MATLAB function to fixed-point MATLAB code. In this example, the MATLAB function name is `dti`.

```
fiaccel -float2fixed fixptcfg dti
```

Alternatives

You can convert floating-point MATLAB code to fixed-point code using the Fixed-Point Converter app. Open the app using one of these methods:

- On the **Apps** tab, in the **Code Generation** section, click **Fixed-Point Converter**.
- Use the `fixedPointConverter` command.

See Also

`coder.mexconfig` | `coder.mexconfig` | `fiaccel`

Topics

“Propose Data Types Based on Simulation Ranges”

“Propose Data Types Based on Derived Ranges”

“Detect Overflows”

“Generate HDL Code from MATLAB Code Using the Command Line Interface” (HDL Coder)

coder.ignoreConst

Prevent use of constant value of expression for function specializations

Syntax

```
coder.ignoreConst(expression)
```

Description

`coder.ignoreConst(expression)` prevents the code generator from using the constant value of `expression` to create function specializations on page 4-152. `coder.ignoreConst(expression)` returns the value of `expression`.

Examples

Prevent Function Specializations Based on Constant Input Values

Use `coder.ignoreConst` to prevent function specializations for a function that is called with constant values.

Write the function `call_myfcn`, which calls `myfcn`.

```
function [x, y] = call_myfcn(n)
    %#codegen
    x = myfcn(n, 'mode1');
    y = myfcn(n, 'mode2');
end

function y = myfcn(n,mode)
    coder.inline('never');
    if strcmp(mode, 'mode1')
        y = n;
    else
        y = -n;
    end
end
```

Generate standalone C code. For example, generate a static library. Enable the code generation report.

```
codegen -config:lib call_myfcn -args {1} -report
```

In the code generation report, you see two function specializations for `call_myfcn`.

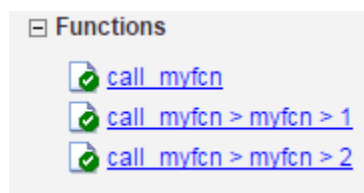

The code generator creates `call_myfcn>myfcn>1` for `mode` with a value of `'mode1'`. It creates `call_myfcn>myfcn>2` for `mode` with a value of `'mode2'`.

In the generated C code, you see the specializations `my_fcn` and `b_my_fcn`.

```
static double b_myfcn(double n)
{
    return -n;
}

static double myfcn(double n)
{
    return n;
}
```

To prevent the function specializations, instruct the code generator to ignore that values of the `mode` argument are constant.

```
function [x, y] = call_myfcn(n)
%#codegen
x = myfcn(n, coder.ignoreConst('mode1'));
y = myfcn(n, coder.ignoreConst('mode2'));
end

function y = myfcn(n,mode)
coder.inline('never');
if strcmp(mode,'mode1')
    y = n;
else
    y = -n;
end
end
```

Generate the C code.

```
codegen -config:lib call_myfcn -args {1} -report
```

In the code generation report, you do not see multiple function specializations.

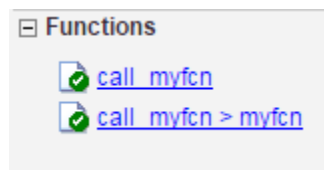

In the generated C code, you see one function for `my_fcn`.

Input Arguments

expression — Expression whose value is to be treated as a nonconstant

MATLAB expression

Expression whose value is to be treated as a nonconstant, specified as a MATLAB expression.

More About

Function Specialization

Version of a function in which an input type, size, complexity, or value is customized for a particular invocation of the function.

Function specialization produces efficient C code at the expense of code duplication. The code generation report shows all MATLAB function specializations that the code generator creates. However, the specializations might not appear in the generated C/C++ code due to later transformations or optimizations.

Tips

- For some recursive function calls, you can use `coder.ignoreConst` to force run-time recursion. See “Force Code Generator to Use Run-Time Recursion”.
- `coder.ignoreConst(expression)` prevents the code generator from using the constant value of `expression` to create function specializations. It does not prevent other uses of the constant value during code generation.

See Also

`coder.inline`

Topics

“Force Code Generator to Use Run-Time Recursion”

“Compile-Time Recursion Limit Reached”

Introduced in R2017a

coder.inline

Control inlining of a specific function in generated code

Syntax

```
coder.inline('always')
coder.inline('never')
coder.inline('default')
```

Description

`coder.inline('always')` forces inlining on page 4-154 of the current function in the generated code. Place the `coder.inline` directive inside the function that you want to inline. The code generator does not inline entry-point functions and recursive functions. Also, the code generator does not inline functions into `parfor` loops, or inline functions called from `parfor` loops.

`coder.inline('never')` prevents inlining of the current function in the generated code. Prevent inlining when you want to simplify the mapping between the MATLAB source code and the generated code.

Note If you use the `codegen` or the `fiaccel` command, you can disable inlining for all functions by using the `-O disable:inline` option.

If you generate C/C++ code by using the `codegen` command or the MATLAB Coder app, you might have different speed and readability requirements for the code generated for functions that you write and the code generated for MathWorks® functions. Certain additional global settings enable you to separately control the inlining behavior for these two parts of the generated code base and at the boundary between them. See .

`coder.inline('default')` instructs the code generator to use internal heuristics to determine whether to inline the current function. Usually, the heuristics produce highly optimized code. Use `coder.inline` explicitly in your MATLAB functions only when you need to fine-tune these optimizations.

Examples

Prevent Function Inlining

In this example, function `foo` is not inlined in the generated code:

```
function y = foo(x)
    coder.inline('never');
    y = x;
end
```

Use `coder.inline` in Control Flow Statements

You can use `coder.inline` in control flow code. If the software detects contradictory `coder.inline` directives, the generated code uses the default inlining heuristic and issues a warning.

Suppose that you want to generate code for a division function that runs on a system with limited memory. To optimize memory use in the generated code, the `inline_division` function manually controls inlining based on whether it performs scalar division or vector division:

```
function y = inline_division(dividend, divisor)

% For scalar division, inlining produces smaller code
% than the function call itself.
if isscalar(dividend) && isscalar(divisor)
    coder.inline('always');
else
% Vector division produces a for-loop.
% Prohibit inlining to reduce code size.
    coder.inline('never');
end

if any(divisor == 0)
    error('Cannot divide by 0');
end

y = dividend / divisor;
```

More About

Inlining

Technique that replaces a function call with the contents (body) of that function. Inlining eliminates the overhead of a function call, but can produce larger C/C++ code. Inlining can create opportunities for further optimization of the generated C/C++ code.

See Also

`fiaccel`

Introduced in R2011a

coder.load

Load compile-time constants from MAT-file or ASCII file into caller workspace

Syntax

```
S = coder.load(filename)
S = coder.load(filename,var1,...,varN)
S = coder.load(filename,'-regex',expr1,...,exprN)
S = coder.load(filename,'-ascii')
S = coder.load(filename,'-mat')
S = coder.load(filename,'-mat',var1,...,varN)
S = coder.load(filename,'-mat','-regex', expr1,...,exprN)
```

Description

`S = coder.load(filename)` loads compile-time constants from `filename`.

- If `filename` is a MAT-file, then `coder.load` loads variables from the MAT-file into a structure array.
- If `filename` is an ASCII file, then `coder.load` loads data into a double-precision array.

`coder.load` loads data at code generation time, also referred to as *compile time*. If you change the content of `filename` after you generate code, the change is not reflected in the behavior of the generated code.

`S = coder.load(filename,var1,...,varN)` loads only the specified variables from the MAT-file `filename`.

`S = coder.load(filename,'-regex',expr1,...,exprN)` loads only the variables that match the specified regular expressions.

`S = coder.load(filename,'-ascii')` treats `filename` as an ASCII file, regardless of the file extension.

`S = coder.load(filename,'-mat')` treats `filename` as a MAT-file, regardless of the file extension.

`S = coder.load(filename,'-mat',var1,...,varN)` treats `filename` as a MAT-file and loads only the specified variables from the file.

`S = coder.load(filename,'-mat','-regex', expr1,...,exprN)` treats `filename` as a MAT-file and loads only the variables that match the specified regular expressions.

Examples

Load compile-time constants from MAT-file

Generate code for a function `edgeDetect1` which given a normalized image, returns an image where the edges are detected with respect to the threshold value. `edgeDetect1` uses `coder.load` to load the edge detection kernel from a MAT-file at compile time.

Save the Sobel edge-detection kernel in a MAT-file.

```
k = [1 2 1; 0 0 0; -1 -2 -1];
```

```
save sobel.mat k
```

Write the function `edgeDetect1`.

```
function edgeImage = edgeDetect1(originalImage, threshold) %#codegen
assert(all(size(originalImage) <= [1024 1024]));
assert(isa(originalImage, 'double'));
assert(isa(threshold, 'double'));

S = coder.load('sobel.mat', 'k');
H = conv2(double(originalImage), S.k, 'same');
V = conv2(double(originalImage), S.k', 'same');
E = sqrt(H.*H + V.*V);
edgeImage = uint8((E > threshold) * 255);
```

Create a code generation configuration object for a static library.

```
cfg = coder.config('lib');
```

Generate a static library for `edgeDetect1`.

```
codegen -report -config cfg edgeDetect1
```

`codegen` generates C code in the `codegen\lib\edgeDetect1` folder.

Load compile-time constants from ASCII file

Generate code for a function `edgeDetect2` which given a normalized image, returns an image where the edges are detected with respect to the threshold value. `edgeDetect2` uses `coder.load` to load the edge detection kernel from an ASCII file at compile time.

Save the Sobel edge-detection kernel in an ASCII file.

```
k = [1 2 1; 0 0 0; -1 -2 -1];
```

```
save sobel.dat k -ascii
```

Write the function `edgeDetect2`.

```
function edgeImage = edgeDetect2(originalImage, threshold) %#codegen
assert(all(size(originalImage) <= [1024 1024]));
assert(isa(originalImage, 'double'));
assert(isa(threshold, 'double'));

k = coder.load('sobel.dat');
H = conv2(double(originalImage), k, 'same');
V = conv2(double(originalImage), k', 'same');
```

```
E = sqrt(H.*H + V.*V);
edgeImage = uint8((E > threshold) * 255);
```

Create a code generation configuration object for a static library.

```
cfg = coder.config('lib');
```

Generate a static library for `edgeDetect2`.

```
codegen -report -config cfg edgeDetect2
```

codegen generates C code in the `codegen\lib\edgeDetect2` folder.

Input Arguments

filename — Name of file

character vector | string scalar

Name of file. `filename` must be a compile-time constant.

`filename` can include a file extension and a full or partial path. If `filename` has no extension, `load` looks for a file named `filename.mat`. If `filename` has an extension other than `.mat`, `load` treats the file as ASCII data.

ASCII files must contain a rectangular table of numbers, with an equal number of elements in each row. The file delimiter (the character between elements in each row) can be a blank, comma, semicolon, or tab character. The file can contain MATLAB comments (lines that begin with a percent sign, %).

Example: `'myFile.mat'`

var1, ..., varN — Names of variables to load

character vector | string scalar

Names of variables, specified as one or more character vectors or string scalars. Each variable name must be a compile-time constant. Use the `*` wildcard to match patterns.

Example: `coder.load('myFile.mat', 'A*')` loads all variables in the file whose names start with `A`.

expr1, ..., exprN — Regular expressions indicating which variables to load

character vector | string scalar

Regular expressions indicating which variables to load specified as one or more character vectors or string scalars. Each regular expression must be a compile-time constant.

Example: `coder.load('myFile.mat', '-regexp', '^A')` loads only variables whose names begin with `A`.

Output Arguments

S — Loaded variables or data

structure array | m-by-n array

If `filename` is a MAT-file, `S` is a structure array.

If `filename` is an ASCII file, `S` is an `m`-by-`n` array of type `double`. `m` is the number of lines in the file and `n` is the number of values on a line.

Limitations

- Arguments to `coder.load` must be compile-time constants.
- The output `S` must be the name of a structure or array without any subscripting. For example, `S(i) = coder.load('myFile.mat')` is not allowed.
- You cannot use `save` to save workspace data to a file inside a function intended for code generation. The code generator does not support the `save` function. Furthermore, you cannot use `coder.extrinsic` with `save`. Prior to generating code, you can use `save` to save workspace data to a file.

Tips

- `coder.load` loads data at compile time, not at run time. If you are generating MEX code or code for Simulink simulation, you can use the MATLAB function `load` to load run-time values.
- If the MAT-file contains unsupported constructs, use `coder.load(filename, var1, ..., varN)` to load only the supported constructs.
- If you generate code in a MATLAB Coder project, the code generator practices incremental code generation for the `coder.load` function. When the MAT-file or ASCII file used by `coder.load` changes, the software rebuilds the code.

See Also

`matfile` | `regexp` | `save`

Topics

“Regular Expressions”

Introduced in R2013a

coder.mexconfig

Package: coder

Code acceleration configuration object

Syntax

```
config_obj = coder.mexconfig
```

Description

`config_obj = coder.mexconfig` creates a `coder.MexConfig` code generation configuration object for use with `fiaccl`, which generates a MEX function.

Output Arguments

config_obj

Code generation configuration object for use when generating MEX functions using `fiaccl`.

Examples

Create a configuration object to disable run-time checks

```
cfg = coder.mexconfig
% Turn off Integrity Checks, Extrinsic Calls,
% and Responsiveness Checks
cfg.IntegrityChecks = false;
cfg.ExtrinsicCalls = false;
cfg.ResponsivenessChecks = false;
% Use fiaccl to generate a MEX function for file foo.m
fiaccl -config cfg foo
```

See Also

`coder.ArrayType` | `coder.Constant` | `coder.EnumType` | `coder.FiType` |
`coder.PrimitiveType` | `coder.StructType` | `coder.Type` | `coder.mexconfig` |
`coder.newtype` | `coder.resize` | `coder.typeof` | `fiaccl`

Introduced in R2011a

coder.newtype

Package: coder

Create `coder.Type` object to represent type of an entry-point function input

Syntax

```
t = coder.newtype(numeric_class,sz,variable_dims)
t = coder.newtype(numeric_class,sz,variable_dims, Name,Value)
t = coder.newtype('constant',value)
t = coder.newtype('struct',struct_fields,sz,variable_dims)
t = coder.newtype('cell',cells,sz,variable_dims)
t = coder.newtype('embedded.fi',numeric_type,sz,variable_dims, Name,Value)
t = coder.newtype(enum_value,sz,variable_dims)
t = coder.newtype('class_name')
t = coder.newtype('string')
```

Description

The `coder.newtype` function is an advanced function that you can use to control the `coder.Type` object. Consider using `coder.typeof` instead of `coder.newtype`. The function `coder.typeof` creates a type from a MATLAB example. By default, `t = coder.newtype('class_name')` does not assign any properties of the class, `class_name` to the object `t`.

Note You can also create and edit `coder.Type` objects interactively by using the Coder Type Editor. See “Create and Edit Input Types by Using the Coder Type Editor”.

`t = coder.newtype(numeric_class,sz,variable_dims)` creates a `coder.Type` object representing values of class `numeric_class`, sizes `sz` (upper bound), and variable dimensions `variable_dims`. If `sz` specifies `inf` for a dimension, then the size of the dimension is unbounded and the dimension is variable-size. When `variable_dims` is not specified, the dimensions of the type are fixed except for those that are unbounded. When `variable_dims` is a scalar, it is applied to type dimensions that are not 1 or 0, which are fixed.

`t = coder.newtype(numeric_class,sz,variable_dims, Name,Value)` creates a `coder.Type` object by using additional options specified as one or more `Name, Value` pair arguments.

`t = coder.newtype('constant',value)` creates a `coder.Constant` object representing a single value. Use this type to specify a value that must be treated as a constant in the generated code.

`t = coder.newtype('struct',struct_fields,sz,variable_dims)` creates a `coder.StructType` object for an array of structures that has the same fields as the scalar structure `struct_fields`. The structure array type has the size specified by `sz` and variable-size dimensions specified by `variable_dims`.

`t = coder.newtype('cell',cells,sz,variable_dims)` creates a `coder.CellType` object for a cell array that has the cells and cell types specified by `cells`. The cell array type has the size

specified by `sz` and variable-size dimensions specified by `variable_dims`. You cannot change the number of cells or specify variable-size dimensions for a heterogeneous cell array.

`t = coder.newtype('embedded.fi', numeric_type, sz, variable_dims, Name, Value)` creates a `coder.FiType` object representing a set of fixed-point values that have `numeric_type` and additional options specified by one or more `Name, Value` pair arguments.

`t = coder.newtype(enum_value, sz, variable_dims)` creates a `coder.Type` object representing a set of enumeration values of class `enum_value`.

`t = coder.newtype('class_name')` creates a `coder.ClassType` object for an object of the class `class_name`. The new object does not have any properties of the class `class_name`.

`t = coder.newtype('string')` creates a type for a string scalar. A string scalar contains one piece of text represented as a character vector. To specify the size of the character vector and whether the second dimension is variable-size, create a type for the character vector and assign it to the `Value` property of the string scalar type. For example, `t.Properties.Value = coder.newtype('char', [1 10], [0 1])` specifies that the character vector inside the string scalar is variable-size with an upper bound of 10.

Examples

Create Type for a Matrix

Create a type for a variable-size matrix of doubles.

```
t = coder.newtype('double', [2 3 4], [1 1 0])
```

```
t =
```

```
coder.PrimitiveType
    :2x:3x4 double
% ':' indicates variable-size dimensions
```

Create a type for a matrix of doubles, first dimension unbounded, and second dimension with fixed size.

```
t = coder.newtype('double', [inf, 3])
```

```
t =
```

```
coder.PrimitiveType
    :infx3 double
```

```
t = coder.newtype('double', [inf, 3], [1 0])
```

```
% also returns
```

```
t =
```

```
coder.PrimitiveType
    :infx3 double
% ':' indicates variable-size dimensions
```

Create a type for a matrix of doubles, first dimension unbounded, and second dimension with variable-size that has an upper bound of 3.

```
t = coder.newtype('double',[inf,3],[0 1])
t =
coder.PrimitiveType
  :inf×3 double
% ':' indicates variable-size dimensions
```

Create Type for a Structure

Create a type for a structure with a variable-size field.

```
ta = coder.newtype('int8',[1 1]);
tb = coder.newtype('double',[1 2],[1 1]);
t = coder.newtype('struct',struct('a',ta,'b',tb),[1 1],[1 1])
t =
coder.StructType
  :1×1 struct
    a: 1×1 int8
    b: :1×2 double
% ':' indicates variable-size dimensions
```

Create Type for a Cell Array

Create a type for a heterogeneous cell array.

```
ta = coder.newtype('int8',[1 1]);
tb = coder.newtype('double',[1 2],[1 1]);
t = coder.newtype('cell',{ta, tb})
t =
coder.CellType
  1×2 heterogeneous cell
    f1: 1×1 int8
    f2: :1×2 double
% ':' indicates variable-size dimensions
```

Create a type for a homogeneous cell array.

```
ta = coder.newtype('int8',[1 1]);
tb = coder.newtype('int8',[1 2],[1 1]);
t = coder.newtype('cell',{ta, tb},[1,1],[1,1])
t =
coder.CellType
  :1×1 homogeneous cell
    base: :1×2 int8
% ':' indicates variable-size dimensions
```

Create Type for a Constant

Create a new constant type to use in code generation.

```
t = coder.newtype('constant',42)
t =
coder.Constant
    42
```

Create a coder.EnumType Object

Create a coder.EnumType object by using the name of an existing MATLAB enumeration.

1. Define an enumeration MyColors. On the MATLAB path, create a file named MyColors containing:

```
classdef MyColors < int32
    enumeration
        green(1),
        red(2),
    end
end
```

2. Create a coder.EnumType object from this enumeration.

```
t = coder.newtype('MyColors')
t =
coder.EnumType
    1x1 MyColors
```

Create a Fixed-Point Type

Create a fixed-point type for use in code generation.

The fixed-point type uses default fimath values.

```
t = coder.newtype('embedded.fi',numerictype(1, 16, 15),[1 2])
t =
coder.FiType
    1x2 embedded.fi
        DataTypeMode: Fixed-point: binary point scaling
        Signedness: Signed
        WordLength: 16
        FractionLength: 15
```

Create a Type for an Object

Create a type for an object to use in code generation.

1. Create this value class:

```
classdef mySquare
    properties
        side;
    end

    methods
        function obj = mySquare(val)
            if nargin > 0
                obj.side = val;
            end
        end

        function a = calcarea(obj)
            a = obj.side * obj.side;
        end
    end
end
```

2. Create a type for an object that has the same properties as mySquare.

```
t = coder.newtype('mySquare');
```

3. The previous step creates a `coder.ClassType` type for `t`, but does not assign any properties of `mySquare` to it. To ensure `t` has all the properties of `mySquare`, change the type of the property `side` by using `t.Properties`.

```
t.Properties.side = coder.typeof(int8(3))
```

```
t =
```

```
coder.ClassType
  1x1 mySquare
    side: 1x1 int8
```

Create Type for a String Scalar

Create a type for a string scalar to use in code generation.

1. Create the string scalar type.

```
t = coder.newtype('string');
```

2. Specify the size.

```
t.Properties.Value = coder.newtype('char',[1,10]);
```

3. Make the string variable-size with an upper bound of 10.

```
t.Properties.Value = coder.newtype('char',[1,10],[0,1]);
```

4. Make the string variable-size with no upper bound.

```
t.Properties.Value = coder.newtype('char',[1,inf]);
```

Input Arguments

numeric_class — Class of values of type object

numeric (default)

Class of the set of values represented by the type object.

Example: `coder.newtype('double',[6,3]);`

Data Types: `half | single | double | int8 | int16 | int32 | int64 | uint8 | uint16 | uint32 | uint64 | logical | char | string | struct | table | cell | function_handle | categorical | datetime | duration | calendarDuration | fi`

Complex Number Support: Yes

struct_fields — Indicates fields in a new structure type

struct (default)

Scalar structure used to specify the fields in a new structure type.

Example: `coder.newtype('struct',struct('a',ta,'b',tb));`

Data Types: `struct`

cells — Specify types of cells in a new cell array type

cell array (default)

Cell array of `coder.Type` objects that specify the types of the cells in a new cell array type.

Example: `coder.newtype('cell',{ta,tb});`

Data Types: `cell`

sz — Dimension of type object

row vector of integer values

Size vector specifying each dimension of type object. The `sz` dimension cannot change the number of cells for a heterogeneous cell array.

Example: `coder.newtype('int8',[1 2]);`

Data Types: `single | double | int8 | int16 | int32 | int64 | uint8 | uint16 | uint32 | uint64`

Complex Number Support: Yes

'class_name' — Name of the class

character vector | string scalar

Name of the class from which the `coder.ClassType` is created. Specify as a character vector or string scalar. `class_name` must be the name of a value class.

Example: `coder.newtype('mySquare')`

Data Types: `char | string`

variable_dims — Variable- or fixed-dimension

row vector of logical values

The value of `variable_dims` is `true` for dimensions for which `sz` specifies an upper bound of `inf`; `false` for all other dimensions.

Logical vector that specifies whether each dimension is variable size (`true`) or fixed size (`false`). You cannot specify variable-size dimensions for a heterogeneous cell array.

Example: `coder.newtype('char',[1,10],[0,1]);`

Data Types: `logical`

value — Value of the constant

constant value (default)

Specifies the actual value of the constant.

Example: `coder.newtype('constant',41);`

Data Types: `single` | `double` | `int8` | `int16` | `int32` | `int64` | `uint8` | `uint16` | `uint32` | `uint64` | `logical` | `char` | `string` | `struct` | `table` | `cell`

enum_value — Enumeration values of class

`enum` (default)

Enumeration values of a class.

Example: `coder.newtype('MyColors');`

Data Types: `single` | `double` | `int8` | `int16` | `int32` | `int64` | `uint8` | `uint16` | `uint32` | `uint64` | `logical` | `char` | `string` | `struct` | `table` | `cell` | `function_handle` | `categorical` | `datetime` | `duration` | `calendarDuration` | `fi`

Complex Number Support: Yes

Name-Value Pair Arguments

Specify optional comma-separated pairs of `Name`, `Value` arguments. `Name` is the argument name and `Value` is the corresponding value. `Name` must appear inside quotes. You can specify several name and value pair arguments in any order as `Name1`, `Value1`, ..., `NameN`, `ValueN`.

Example: `coder.newtype('embedded.fi',numericType(1,16,15),[1 2])`

complex — Type representing complex values

`true`

Set `complex` to `true` to create a `coder.Type` object that can represent complex values. The type must support complex data.

fimath — Type representing fimath values

`numeric` (default)

Specify local `fimath`. If you do not specify `fimath`, the code generator uses default `fimath` values.

Use with only

```
t = coder.newtype('embedded.fi',numericType,sz,variable_dims,Name,Value)
```

sparse — Type representing sparse data

`false` (default)

Set `sparse` to `true` to create a `coder.Type` object representing sparse data. The type must support sparse data.

Not for use with

```
t = coder.newtype('embedded.fi', numeric_type, sz, variable_dims, Name, Value)
```

gpu — Type representing GPU inputs

`false` (default)

Set `gpu` to `true` to create a `coder.Type` object that can represent the GPU input type. This option requires GPU Coder™.

Output Arguments

t — New type object

`coder.Type` object

A new `coder.Type` object.

Limitations

- For sparse matrices, `coder.newtype` drops upper bounds for variable-size dimensions.
- For GPU input types, only bounded numeric and logical base types are supported. Scalar GPU arrays, structures, cell-arrays, classes, enumerated types, character, half-precision and fixed-point data types are not supported.
- When using `coder.newtype` to represent GPU inputs, the memory allocation (`malloc`) mode property of the GPU code configuration object to `'discrete'`.

Tips

- The `coder.newtype` function fixes the size of a singleton dimension unless the `variable_dims` argument explicitly specifies that the singleton dimension has a variable size.

For example, this code specifies a 1-by-:10 double. The first dimension (the singleton dimension) has a fixed size. The second dimension has a variable size.

```
t = coder.newtype('double', [1 10], 1)
```

By contrast, this code specifies a :1-by-:10 double. Both dimensions have a variable size.

```
t = coder.newtype('double', [1 10], [1 1])
```

- For a MATLAB Function block, singleton dimensions of input or output signals cannot have a variable size.

Alternatives

`coder.typeof`

See Also

`coder.ArrayType` | `coder.CellType` | `coder.EnumType` | `coder.FiType` | `coder.PrimitiveType` | `coder.StructType` | `coder.Type` | `coder.resize` | `fiaccel`

Topics

“Create and Edit Input Types by Using the Coder Type Editor”

Introduced in R2011a

coder.nullcopy

Package: coder

Declare uninitialized variables in code generation

Syntax

```
X = coder.nullcopy(A)
```

Description

`X = coder.nullcopy(A)` copies type, size, and complexity of `A` to `X`, but does not copy element values. The function preallocates memory for `X` without incurring the overhead of initializing memory. In code generation, the `coder.nullcopy` function declares uninitialized variables. In MATLAB, `coder.nullcopy` returns the input such that `X` is equal to `A`.

If `X` is a structure or a class containing variable-sized arrays, then you must assign the size of each array. `coder.nullcopy` does not copy sizes of arrays or nested arrays from its argument to its result.

Note Before you use `X` in a function or a program, ensure that the data in `X` is completely initialized. Declaring a variable through `coder.nullcopy` without assigning all the elements of the variable results in nondeterministic program behavior. For more information, see “How to Eliminate Redundant Copies by Defining Uninitialized Variables”.

Examples

Declare Variables for Optimized Initialization

Declare variable `X` as a 1-by-5 vector of real doubles without performing an unnecessary initialization:

```
function X = foo %#codegen

N = 5;
X = coder.nullcopy(zeros(1,N));
for i = 1:N
    if mod(i,2) == 0
        X(i) = i;
    else
        X(i) = 0;
    end
end
```

Using `coder.nullcopy` with `zeros` lets you specify the size of vector `X` without initializing each element to zero.

Input Arguments

A — Variable to copy

scalar | vector | matrix | class | multidimensional array

Variable to copy, specified as a scalar, vector, matrix, or multidimensional array.

Example: `coder.nullcopy(A)`;

Data Types: `single` | `double` | `int8` | `int16` | `int32` | `int64` | `uint8` | `uint16` | `uint32` | `uint64` | `logical` | `char` | `string` | `class`

Complex Number Support: Yes

Limitations

- You cannot use `coder.nullcopy` on sparse matrices.
- You cannot use `coder.nullcopy` with classes that support overloaded parentheses or require indexing methods to access their data, such as `table`.

See Also

Topics

“Eliminate Redundant Copies of Variables in Generated Code”

Introduced in R2011a

coder.PrimitiveType class

Package: coder

Superclasses: coder.ArrayType

Represent set of logical, numeric, or char arrays

Description

Specifies the set of logical, numeric, or char values that the generated code should accept. Supported classes are `half`, `double`, `single`, `int8`, `uint8`, `int16`, `uint16`, `int32`, `uint32`, `int64`, `uint64`, `char`, and `logical`. Use only with the `fiaccl -args` option. Do not pass as an input to a generated MEX function.

Construction

Note You can also create and edit `coder.Type` objects interactively by using the Coder Type Editor. See “Create and Edit Input Types by Using the Coder Type Editor”.

`t=coder.typeof(v)` creates a `coder.PrimitiveType` object denoting the smallest non-constant type that contains `v`. `v` must be a MATLAB numeric, logical or char.

`t=coder.typeof(v, sz, variable_dims)` returns a modified copy of `coder.typeof(v)` with (upper bound) size specified by `sz` and variable dimensions `variable_dims`. If `sz` specifies `inf` for a dimension, then the size of the dimension is assumed to be unbounded and the dimension is assumed to be variable sized. When `sz` is `[]`, the (upper bound) sizes of `v` remain unchanged. When `variable_dims` is not specified, the dimensions of the type are assumed to be fixed except for those that are unbounded. When `variable_dims` is a scalar, it is applied to bounded dimensions that are not 1 or 0 (which are assumed to be fixed).

`t=coder.newtype(numeric_class, sz, variable_dims)` creates a `coder.PrimitiveType` object representing values of class `numeric_class` with (upper bound) sizes `sz` and variable dimensions `variable_dims`. If `sz` specifies `inf` for a dimension, then the size of the dimension is assumed to be unbounded and the dimension is assumed to be variable sized. When `variable_dims` is not specified, the dimensions of the type are assumed to be fixed except for those that are unbounded. When `variable_dims` is a scalar, it is applied to the dimensions of the type that are not 1 or 0 (which are assumed to be fixed).

`t=coder.newtype(numeric_class, sz, variable_dims, Name, Value)` creates a `coder.PrimitiveType` object with additional options specified by one or more `Name, Value` pair arguments. `Name` can also be a property name and `Value` is the corresponding value. Specify `Name` as character vector or string scalar. You can specify several name-value pair arguments in any order as `Name1, Value1, ..., NameN, ValueN`.

Input Arguments

v

Input that is not a `coder.Type` object

sz

Size for corresponding dimension of type object. Size must be a valid size vector.

Default: [1 1] for `coder.newtype`

variable_dims

Logical vector that specifies whether each dimension is variable size (true) or fixed size (false).

Default: `false(size(sz)) | sz==Inf` for `coder.newtype`

numeric_class

Class of type object.

Name-Value Pair Arguments

Specify optional comma-separated pairs of `Name`, `Value` arguments. `Name` is the argument name and `Value` is the corresponding value. `Name` must appear inside quotes. You can specify several name and value pair arguments in any order as `Name1, Value1, ..., NameN, ValueN`.

complex

Set `complex` to `true` to create a `coder.PrimitiveType` object that can represent complex values. The type must support complex data.

Character arrays do not support complex data.

Default: `false`

sparse

Set `sparse` to `true` to create a `coder.PrimitiveType` object representing sparse data. The type must support sparse data.

Character and half-precision data types do not support sparse data.

Default: `false`

gpu

Set `gpu` to `true` to create a `coder.PrimitiveType` object that can represent GPU input type. This option requires a valid GPU Coder license.

Character and half-precision data types do not support GPU Arrays.

Default: `false`

Properties**ClassName**

Class of values in this set

Complex

Indicates whether the values in this set are real (`false`) or complex (`true`)

SizeVector

The upper-bound size of arrays in this set.

Sparse

Indicates whether the values in this set are sparse arrays (`true`)

VariableDims

A vector used to specify whether each dimension of the array is fixed or variable size. If a vector element is `true`, the corresponding dimension is variable size.

Copy Semantics

Value. To learn how value classes affect copy operations, see Copying Objects.

Examples

Create a `coder.PrimitiveType` object.

```
z = coder.typeof(0,[2 3 4],[1 1 0]) % returns double :2x:3x4
% ':' indicates variable-size dimensions
```

See Also

`coder.ArrayType` | `coder.ClassType` | `coder.Type` | `coder.newtype` | `coder.resize` | `coder.typeof` | `fiaccl`

Topics

“Create and Edit Input Types by Using the Coder Type Editor”

Introduced in R2011a

coder.resize

Package: coder

Resize coder.Type object

Syntax

```
t_out = coder.resize(t,sz)
t_out = coder.resize(t,sz,variable_dims)
t_out = coder.resize(t,[],variable_dims)
t_out = coder.resize(t,sz,variable_dims,Name,Value)
t_out = coder.resize(t,'sizelimits',limits)
```

Description

`t_out = coder.resize(t,sz)` resizes `t` to have size `sz`.

`t_out = coder.resize(t,sz,variable_dims)` returns a modified copy of coder.Type `t` with (upper-bound) size `sz` and variable dimensions `variable_dims`. If `variable_dims` or `sz` are scalars, the function applies the scalars to all dimensions of `t`. By default, `variable_dims` does not apply to dimensions where `sz` is 0 or 1, which are fixed. Use the 'uniform' option to override this special case. The `coder.resize` function ignores `variable_dims` for dimensions with size `inf`. These dimensions are variable size. `t` can be a cell array of types, in which case, `coder.resize` resizes all elements of the cell array.

`t_out = coder.resize(t,[],variable_dims)` changes `t` to have variable dimensions `variable_dims` while leaving the size unchanged.

`t_out = coder.resize(t,sz,variable_dims,Name,Value)` resizes `t` by using additional options specified by one or more Name, Value pair arguments.

`t_out = coder.resize(t,'sizelimits',limits)` resizes the individual dimensions of `t` based on the threshold values in the `limits` vector. The `limits` vector is a row vector containing two positive integer elements. Each dimension of `t` is individually resized according to the thresholds in the `limits` vector.

- When the size `S` of a dimension is lesser than both thresholds defined in `limits`, the dimension remains the same.
- When the size `S` of a dimension is greater than or equal to the first threshold and less than the second threshold defined in `limits`, the dimension becomes variable size with upper bound `S`.
- However, when the size `S` of a dimension is also greater than or equal to the second threshold defined in `limits`, the dimension becomes an unbounded variable size.

If the value of `limits` is scalar, the threshold gets scalar-expanded to represent both thresholds. For example, if `limits` is defined as 4, it is interpreted as [4 4].

The 'sizelimits' option allows you to dynamically allocate memory to large arrays in your generated code.

Examples

Change Fixed-Size Array to an Unbounded, Variable-Size Array

Change a fixed-size array to an unbounded, variable-size array.

```
t = coder.typeof(ones(3,3))
t =
coder.PrimitiveType
    3x3 double
coder.resize(t,inf)
ans =
coder.PrimitiveType
    :infx:inf double
% ':' indicates variable-size dimensions
```

Change Fixed-Size Array to a Bounded, Variable-Size Array

Change a fixed-size array to a bounded, variable-size array.

```
t = coder.typeof(ones(3,3))
t =
coder.PrimitiveType
    3x3 double
coder.resize(t,[4 5],1)
ans =
coder.PrimitiveType
    :4x:5 double
% ':' indicates variable-size dimensions
```

Resize Structure Field

Resize a structure field.

```
ts = coder.typeof(struct('a',ones(3, 3)))
ts =
coder.StructType
    1x1 struct
        a: 3x3 double
coder.resize(ts,[5, 5], 'recursive',1)
```

```
ans =  
  
coder.StructType  
  5×5 struct  
    a: 5×5 double
```

Resize Cell Array

Resize a cell array.

```
tc = coder.typeof({1 2 3})  
  
tc =  
  
coder.CellType  
  1×3 homogeneous cell  
    base: 1×1 double  
  
coder.resize(tc,[5, 5], 'recursive',1)  
  
ans =  
  
coder.CellType  
  5×5 homogeneous cell  
    base: 1×1 double
```

Change Fixed-Sized Array to Variable-Size Based on Bounded and Unbounded Thresholds

Change a fixed-sized array to a variable size based on bounded and unbounded thresholds.

```
t = coder.typeof(ones(100,200))  
  
t =  
  
coder.PrimitiveType  
  100×200 double  
  
coder.resize(t, 'sizelimits',[99 199])  
  
ans =  
  
coder.PrimitiveType  
  :100×:inf double  
% ':' indicates variable-size dimensions
```

Input Arguments

limits — Vector that defines the threshold

row vector of integer values

A row vector of variable-size thresholds. If the value of `limits` is scalar, the threshold gets scalar-expanded. If the size `sz` of a dimension of `t` is greater than or equal to the first threshold and less than the second threshold defined in `limits`, the dimension becomes variable size with upper bound

sz. If the size **sz** of a dimension of **t** is also greater than or equal to the second threshold, the dimension becomes an unbounded variable size.

However, if the size **sz** is lesser than both thresholds, the dimension remains the same.

Example: `coder.resize(t, 'sizelimits', [99 199]);`

Data Types: `single` | `double` | `int8` | `int16` | `int32` | `int64` | `uint8` | `uint16` | `uint32` | `uint64`

sz — New size for object type

row vector of integer values

New size for `coder.Type` object, **t_out**

Example: `coder.resize(t, [3,4]);`

Data Types: `single` | `double` | `int8` | `int16` | `int32` | `int64` | `uint8` | `uint16` | `uint32` | `uint64`

t — coder.Type object that you want to resize

`coder.Type` object

If **t** is a `coder.CellType` object, the `coder.CellType` object must be homogeneous.

Example: `coder.resize(t, inf);`

Data Types: `single` | `double` | `int8` | `int16` | `int32` | `int64` | `uint8` | `uint16` | `uint32` | `uint64` | `logical` | `char` | `string` | `struct` | `table` | `cell` | `function_handle` | `categorical` | `datetime` | `duration` | `calendarDuration` | `fi`

Complex Number Support: Yes

variable_dims — Variable or fixed dimension

row vector of logical values

Specify whether each dimension of **t_out** is fixed size or variable size.

Example: `coder.resize(t, [4 5], 1);`

Data Types: `logical`

Name-Value Pair Arguments

Specify optional comma-separated pairs of **Name**, **Value** arguments. **Name** is the argument name and **Value** is the corresponding value. **Name** must appear inside quotes. You can specify several name and value pair arguments in any order as `Name1, Value1, ..., NameN, ValueN`.

Example: `coder.resize(t, [5, 5], 'recursive', 1);`

recursive — Resize t and all types contained within it

false (default) | true

Setting `recursive` to `true` resizes **t** and all types contained within it.

Data Types: `logical`

uniform — Resize t by applying the heuristic for dimensions of size one

false (default) | true

Setting `uniform` to `true` resizes **t** and applies the heuristic for dimensions of size one.

The heuristic works in the following manner:

- If `variable_dims` is a scalar `true`, all dimensions are resized to upper bound variable sizes specified in `sz`. This includes dimensions of size one. For example:

```
t = coder.typeof(1, [1 5]);
tResize = coder.resize(t,[1 7],true,'uniform',true);
```

This generates an object `tResize` as shown:

```
tResize =

coder.PrimitiveType
    :1x:7 double

    Edit Type Object
```

- If you set `uniform` to `true` with the `'sizelimits'` option, the dimensions of size one are also resized to variable size, according to the `'sizelimits'` heuristics. For example:

```
t = coder.typeof(1, [1 5]);
tResize = coder.resize(t,[],'sizelimits',[0 6],'uniform',true);
```

These commands generate an object `tResize` as shown:

```
tResize =

coder.PrimitiveType
    :1x:5 double

    Edit Type Object
```

- If `variable_dims` is specified as a non-scalar logical, the `uniform` setting has no effect. However, if `variable_dims` is scalar and `uniform` is set to `false`, only dimensions of size greater than one are resized.

Data Types: `logical`

sizelimits — Resize individual dimensions of `t` according to thresholds provided in the **limits** vector

`limits` (default)

Using the `sizelimits` options with `limits` vector resizes individual dimensions of `t`.

```
t = coder.typeof(1, [1 5]);
tResize = coder.resize(t,[],'sizelimits',[0 6],'uniform',true);
```

Data Types: `single` | `double` | `int8` | `int16` | `int32` | `int64` | `uint8` | `uint16` | `uint32` | `uint64`

Output Arguments

t_out — Resized type object

`coder.Type` object

Resized `coder.Type` object

Data Types: `single` | `double` | `int8` | `int16` | `int32` | `int64` | `uint8` | `uint16` | `uint32` | `uint64` | `logical` | `char` | `string` | `struct` | `table` | `cell` | `function_handle` | `categorical` | `datetime` | `duration` | `calendarDuration` | `fi`
Complex Number Support: Yes

Limitations

- For sparse matrices, `coder.resize` drops the upper bounds for variable-size dimensions.

See Also

`coder.newtype` | `coder.typeof` | `fiaccel`

Introduced in R2011a

coder.screener

Package: coder

Determine if function is suitable for code generation

Syntax

```
coder.screener(fcn)
coder.screener(fcn, '-gpu')
coder.screener(fcn_1, ..., fcn_n)
```

Description

`coder.screener(fcn)` analyzes the entry-point MATLAB function `fcn` to identify unsupported functions and language features as code generation compliance issues. The code generation compliance issues are displayed in the readiness report.

If `fcn` calls other functions directly or indirectly that are not MathWorks functions (MATLAB built-in functions and toolbox functions), `coder.screener` analyzes these functions. It does not analyze the MathWorks functions.

It is possible that `coder.screener` does not detect all code generation issues. Under certain circumstances, it is possible that `coder.screener` reports false errors.

To avoid undetected code generation issues and false errors, before generating code, verify that your MATLAB code is suitable for code generation by performing these additional checks:

- Before using `coder.screener`, fix issues that the Code Analyzer identifies.
- After using `coder.screener`, and before generating C/C++ code, verify that your MATLAB code is suitable for code generation by generating and verifying a MEX function.

The `coder.screener` function does not report functions that the code generator treats as extrinsic. Examples of such functions are `plot`, `disp`, and `figure`. See “Use MATLAB Engine to Execute a Function Call in Generated Code”.

`coder.screener(fcn, '-gpu')` analyzes the entry-point MATLAB function `fcn` to identify unsupported functions and language features for GPU code generation. This option requires a GPU Coder license.

`coder.screener(fcn_1, ..., fcn_n)` analyzes multiple entry-point MATLAB functions.

Examples

Identify Unsupported Functions

The `coder.screener` function identifies calls to functions that are not supported for code generation. It checks the entry-point function, `foo1`, and the function, `foo2`, that `foo1` calls.

Write the function `foo2` and save it in the file `foo2.m`.

```
function tf = foo2(source,target)
G = digraph(source,target);
tf = isdag(G);
end
```

Write the function `foo1` that calls `foo2`. Save `foo1` in the file `foo1.m`.

```
function tf = foo1(source,target)
assert(numel(source)==numel(target))
tf = foo2(source,target);
end
```

Analyze `foo1`.

```
coder.screener('foo1')
```

The Code Generation Readiness report displays a summary of the unsupported MATLAB function calls. The report **Summary** tab indicates that `foo2.m` contains one call to the `digraph` function and one call to the `isdag` function, which are not supported for code generation.

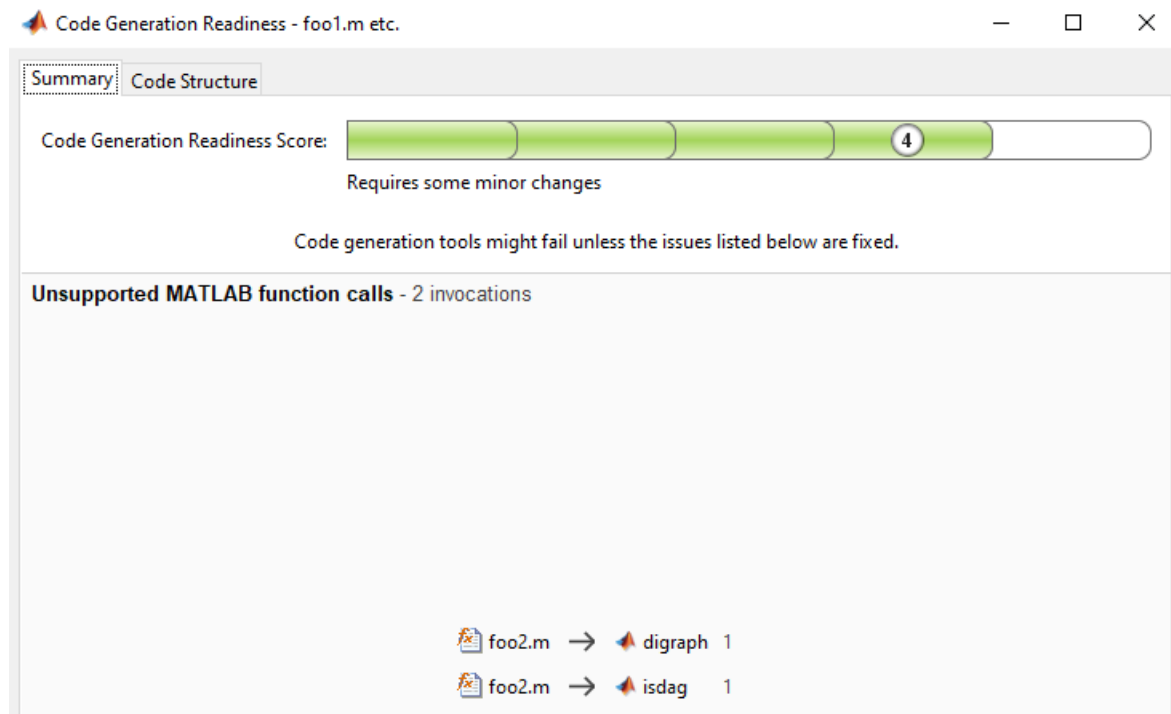

In the report, click the **Code Structure** tab and select the **Show MATLAB functions** check box.

This tab displays a pie chart showing the relative size of each file and how suitable each file is for code generation. The report displays:

- Green: Function (`foo1.m`) suitable for code generation.
- Yellow: Function (`foo2.m`) requires significant changes.

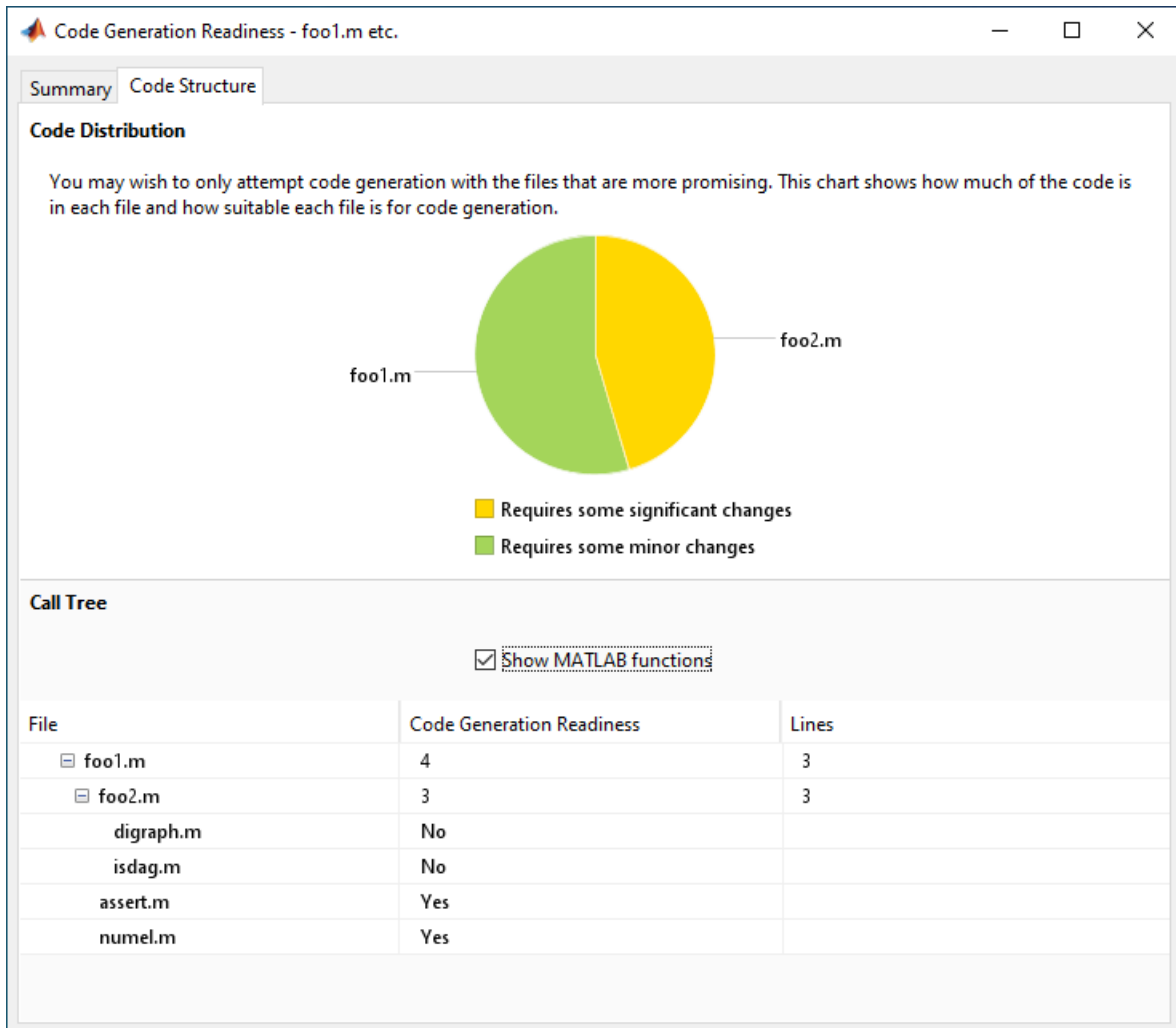

The report also displays a **Call Tree** with **Code Generation Readiness Score**. The score is based on a scale of 1-5. 1 indicates that significant changes are required. 5 indicates that the code generation readiness tool does not detect issues. In this example, the report assigns `foo1.m` a code generation readiness score of 4 and `foo2.m` a score of 3.

The function `foo2` calls two unsupported MATLAB functions. To generate a MEX function, modify the code to make the calls to `digraph` and `isdag` extrinsic by using the `coder.extrinsic` directive, and then rerun the code generation readiness tool.

```
function tf = foo2(source,target)
coder.extrinsic('digraph','isdag');
G = digraph(source,target);
tf = isdag(G);
end
```

Rerun `coder.screener` on the entry-point function `foo1`.

```
coder.screener('foo1')
```

The report no longer flags that code generation does not support the `digraph` and `dag` functions. When you generate a MEX function for `foo1`, the code generator dispatches these two functions to MATLAB for execution.

Identify Unsupported Data Types

The `coder.screener` function identifies MATLAB data types that code generation does not support.

Write the function `myfun1` that contains a MATLAB calendar duration array data type.

```
function out = myfun1(A)
out = calyears(A);
end
```

Analyze `myfun1`.

```
coder.screener('myfun1');
```

The code generation readiness report indicates that the `calyears` data type is not supported for code generation.

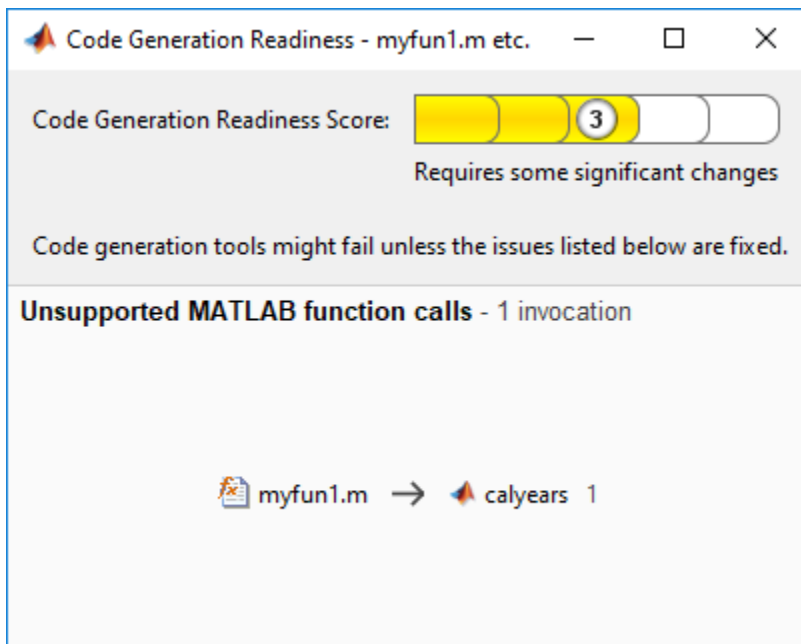

The report assigns `myfun1` a code generation readiness score of 3. Before generating code, fix the reported issues.

Input Arguments

fcn — Name of entry-point function

character vector | string scalar

Name of entry-point MATLAB function for analysis. Specify as a character vector or a string scalar.

Example: `coder.screener('myfun');`

Data Types: char | string

fcn_1, ..., fcn_n — List of entry-point function names

character vector | string scalar

Comma-separated list of entry-point MATLAB function names for analysis. Specify as character vectors or string scalars.

Example: `coder.screener('myfun1','myfun2');`

Data Types: char | string

Alternatives

- “Run the Code Generation Readiness Tool From the Current Folder Browser”

See Also

`coder.extrinsic` | `fiaccel`

Topics

“Functions Supported for Code Acceleration or C Code Generation”

“Code Generation Readiness Tool”

Introduced in R2012b

coder.StructType class

Package: coder

Superclasses: coder.ArrayType

Represent set of MATLAB structure arrays

Description

Specifies the set of structure arrays that the generated code should accept. Use only with the `fiaccl -args` option. Do not pass as an input to a generated MEX function.

Construction

Note You can also create and edit `coder.Type` objects interactively by using the Coder Type Editor. See “Create and Edit Input Types by Using the Coder Type Editor”.

`t=coder.typeof(struct_v)` creates a `coder.StructType` object for a structure with the same fields as the scalar structure `struct_v`.

`t=coder.typeof(struct_v, sz, variable_dims)` returns a modified copy of `coder.typeof(struct_v)` with (upper bound) size specified by `sz` and variable dimensions `variable_dims`. If `sz` specifies `inf` for a dimension, then the size of the dimension is assumed to be unbounded and the dimension is assumed to be variable sized. When `sz` is `[]`, the (upper bound) sizes of `struct_v` remain unchanged. If the `variable_dims` input parameter is not specified, the dimensions of the type are assumed to be fixed except for those that are unbounded. When `variable_dims` is a scalar, it is applied to the bounded dimensions that are not 1 or 0 (which are assumed to be fixed).

`t=coder.newtype('struct', struct_v, sz, variable_dims)` creates a `coder.StructType` object for an array of structures with the same fields as the scalar structure `struct_v` and (upper bound) size `sz` and variable dimensions `variable_dims`. If `sz` specifies `inf` for a dimension, then the size of the dimension is assumed to be unbounded and the dimension is assumed to be variable sized. When `variable_dims` is not specified, the dimensions of the type are assumed to be fixed except for those that are unbounded. When `variable_dims` is a scalar, it is applied to the dimensions of the type, except if the dimension is 1 or 0, which is assumed to be fixed.

Input Arguments

struct_v

Scalar structure used to specify the fields in a new structure type.

sz

Size vector specifying each dimension of type object.

Default: `[1 1]` for `coder.newtype`

variable_dims

Logical vector that specifies whether each dimension is variable size (true) or fixed size (false).

Default: false(size(sz)) | sz==Inf for `coder.newtype`

Properties**Alignment**

The run-time memory alignment of structures of this type in bytes. If you have an Embedded Coder® license and use Code Replacement Libraries (CRLs), the CRLs provide the ability to align data objects passed into a replacement function to a specified boundary. This capability allows you to take advantage of target-specific function implementations that require data to be aligned. By default, the structure is not aligned on a specific boundary so it will not be matched by CRL functions that require alignment.

Alignment must be either -1 or a power of 2 that is no more than 128.

ClassName

Class of values in this set.

Extern

Whether the structure type is externally defined.

Fields

A structure giving the `coder.Type` of each field in the structure.

HeaderFile

If the structure type is externally defined, name of the header file that contains the external definition of the structure, for example, "mystruct.h".

By default, the generated code contains `#include` statements for custom header files after the standard header files. If a standard header file refers to the custom structure type, then the compilation fails. By specifying the `HeaderFile` option, MATLAB Coder includes that header file exactly at the point where it is required.

Must be a non-empty character vector or string scalar.

SizeVector

The upper-bound size of arrays in this set.

VariableDims

A vector used to specify whether each dimension of the array is fixed or variable size. If a vector element is `true`, the corresponding dimension is variable size.

Copy Semantics

Value. To learn how value classes affect copy operations, see Copying Objects.

Examples

Create a type for a structure with a variable-size field.

```
x.a = coder.typeof(0,[3 5],1);
x.b = magic(3);
coder.typeof(x)
% Returns
% coder.StructType
% 1x1 struct
%   a: :3x:5 double
%   b: 3x3 double
% ':' indicates variable-size dimensions
```

See Also

[coder.ArrayType](#) | [coder.ClassType](#) | [coder.Constant](#) | [coder.EnumType](#) | [coder.FiType](#) | [coder.PrimitiveType](#) | [coder.Type](#) | [coder.newtype](#) | [coder.resize](#) | [coder.typeof](#) | [fiaccel](#)

Topics

“Create and Edit Input Types by Using the Coder Type Editor”

Introduced in R2011a

coder.target

Determine if code generation target is specified target

Syntax

```
tf = coder.target(target)
```

Description

`tf = coder.target(target)` returns true (1) if the code generation target is `target`. Otherwise, it returns false (0).

If you generate code for MATLAB classes, MATLAB computes class initial values at class loading time before code generation. If you use `coder.target` in MATLAB class property initialization, `coder.target('MATLAB')` returns true.

Examples

Use coder.target to Parametrize a MATLAB Function

Parametrize a MATLAB function so that it works in MATLAB or in generated code. When the function runs in MATLAB, it calls the MATLAB function `myabsval`. The generated code, however, calls a C library function `myabsval`.

Write a MATLAB function `myabsval`.

```
function y = myabsval(u)
%#codegen
y = abs(u);
```

Generate a C static library for `myabsval`, using the `-args` option to specify the size, type, and complexity of the input parameter.

```
codegen -config:lib myabsval -args {0.0}
```

The `codegen` function creates the library file `myabsval.lib` and header file `myabsval.h` in the folder `\codegen\lib\myabsval`. (The library file extension can change depending on your platform.) It generates the functions `myabsval_initialize` and `myabsval_terminate` in the same folder.

Write a MATLAB function to call the generated C library function using `coder.ceval`.

```
function y = callmyabsval(y)
%#codegen
% Check the target. Do not use coder.ceval if callmyabsval is
% executing in MATLAB
if coder.target('MATLAB')
    % Executing in MATLAB, call function myabsval
    y = myabsval(y);
else
```

```

% add the required include statements to generated function code
coder.updateBuildInfo('addIncludePaths','$(START_DIR)\codegen\lib\myabsval');
coder.cinclude('myabsval_initialize.h');
coder.cinclude('myabsval.h');
coder.cinclude('myabsval_terminate.h');

% Executing in the generated code.
% Call the initialize function before calling the
% C function for the first time
coder.ceval('myabsval_initialize');

% Call the generated C library function myabsval
y = coder.ceval('myabsval',y);

% Call the terminate function after
% calling the C function for the last time
coder.ceval('myabsval_terminate');
end

```

Generate the MEX function `callmyabsval_mex`. Provide the generated library file at the command line.

```
codegen -config:mex callmyabsval codegen\lib\myabsval\myabsval.lib -args {-2.75}
```

Rather than providing the library at the command line, you can use to specify the library within the function. Use this option to preconfigure the build. Add this line to the `else` block:

```
coder.updateBuildInfo('addLinkObjects','myabsval.lib','$(START_DIR)\codegen\lib\myabsval',100,tru
```

Run the MEX function `callmyabsval_mex` which calls the library function `myabsval`.

```
callmyabsval_mex(-2.75)
```

```
ans =
    2.7500
```

Call the MATLAB function `callmyabsval`.

```
callmyabsval(-2.75)
```

```
ans =
    2.7500
```

The `callmyabsval` function exhibits the desired behavior for execution in MATLAB and in code generation.

Input Arguments

target — code generation target

```
'MATLAB' | 'MEX' | 'Sfun' | 'Rtw' | 'HDL' | 'Custom'
```

Code generation target, specified as a character vector or a string scalar. Specify one of these targets.

'MATLAB'	Running in MATLAB (not generating code)
----------	---

'MEX'	Generating a MEX function
'Sfun'	Simulating a Simulink model. Also used for running in Accelerator mode.
'Rtw'	Generating a LIB, DLL, or EXE target. Also used for running in Simulink Coder and Rapid Accelerator mode.
'HDL'	Generating an HDL target
'Custom'	Generating a custom target

Example: `tf = coder.target('MATLAB')`

Example: `tf = coder.target("MATLAB")`

See Also

Introduced in R2011a

coder.Type class

Package: coder

Represent set of MATLAB values

Description

Specifies the set of values that the generated code should accept. Use only with the `fiaccel -args` option. Do not pass as an input to a generated MEX function.

Construction

Note You can also create and edit `coder.Type` objects interactively by using the Coder Type Editor. See “Create and Edit Input Types by Using the Coder Type Editor”.

`coder.Type` is an abstract class, and you cannot create instances of it directly. You can create `coder.Constant`, `coder.EnumType`, `coder.FiType`, `coder.PrimitiveType`, `coder.StructType`, and `coder.CellType` objects that are derived from this class.

Properties

ClassName

Class of values in this set

Copy Semantics

Value. To learn how value classes affect copy operations, see Copying Objects.

See Also

`coder.ArrayType` | `coder.CellType` | `coder.Constant` | `coder.EnumType` | `coder.FiType` | `coder.PrimitiveType` | `coder.StructType` | `coder.newtype` | `coder.resize` | `coder.typeof` | `fiaccel`

Topics

“Create and Edit Input Types by Using the Coder Type Editor”

Introduced in R2011a

coderTypeEditor

Launch the Coder Type Editor dialog

Syntax

```
coderTypeEditor
coderTypeEditor var1 ... varN
coderTypeEditor -all
coderTypeEditor -close
```

Description

`coderTypeEditor` opens an empty Coder Type Editor dialog. If a dialog is already open, this command brings it to the front of the screen.

You can use the Coder Type Editor to create and edit `coder.Type` objects interactively. See “Create and Edit Input Types by Using the Coder Type Editor”.

`coderTypeEditor var1 ... varN` opens a Coder Type Editor dialog pre-populated with `coder.Type` objects corresponding to the workspace variables `var1` through `varN`. For a variable `var`, the name of the generated `coder.Type` object is `varType`.

`coderTypeEditor -all` opens a Coder Type Editor dialog pre-populated with `coder.Type` objects corresponding to all compatible variables in the current workspace.

`coderTypeEditor -close` closes an open Coder Type Editor dialog.

Examples

Open Coder Type Editor Populated with Types for Existing Variables

In your MATLAB workspace, define variables `var1`, `var2`, and `var3`.

```
myArray = magic(4);
myCharVector = 'Hello, World!';
myStruct = struct('a',5,'b','mystring');
```

Open the type editor pre-populated with types for `var1`, `var2`, and `var3`.

```
coderTypeEditor myArray myCharVector myStruct
```

The Coder Type Editor dialog opens. The **Type Browser** pane displays the name, class (data type), and size for `coder.Type` objects `myArrayType`, `myCharVectorType`, and `myStructType` for the three workspace variables.

Inspect the created types and check that they are consistent with the variables in the workspace.

- `myArrayType` represents a 4-by-4 array of type `double`.
- `myCharVectorType` represents a 1-by-13 character row vector.

- `myStructType` represents a scalar of type `struct`. Expand the tree corresponding to `myStructType` in the **Type Browser**. The field `a` represents a scalar double. The field `b` represents a 1-by-8 character vector.

To save these types in the base workspace, in the Coder Type Editor toolstrip, click **Save**. The variables `myArrayType`, `myCharVectorType`, and `myStructType` appear in the base workspace.

Input Arguments

var1 ... varN — Workspace variables whose types you intend to view in the type editor

value belonging to a fundamental MATLAB class that supports code generation | value object | handle object | `coder.Type` object

Workspace variables whose types you intend to view in the type editors. They can store any value that is compatible with code generation.

The value can also be a `coder.Type` object. In that case, the `coder.Type` object itself opens in the type editor.

Data Types: `single` | `double` | `int8` | `int16` | `int32` | `int64` | `uint8` | `uint16` | `uint32` | `uint64` | `logical` | `char` | `string` | `struct` | `table` | `cell` | `categorical` | `datetime` | `duration` | `timetable` | `fi` | value object | `coder.Type` object

Complex Number Support: Yes

See Also

`coder.newtype` | `coder.typeof`

Topics

“Create and Edit Input Types by Using the Coder Type Editor”

Introduced in R2020a

coder.typeof

Package: coder

Create `coder.Type` object to represent the type of an entry-point function input

Syntax

```
type_obj = coder.typeof(v)
type_obj = coder.typeof(v,sz,variable_dims)
type_obj = coder.typeof(v,'Gpu', true)
type_obj = coder.typeof(type_obj)
```

Description

Note You can also create and edit `coder.Type` objects interactively by using the `Coder Type Editor`. See “Create and Edit Input Types by Using the Coder Type Editor”.

`type_obj = coder.typeof(v)` creates an object that is derived from `coder.Type` to represent the type of `v` for code generation. Use `coder.typeof` to specify only input parameter types. For example, use it with the `fiaccl` function `-args` option. Do not use it in MATLAB code from which you intend to generate a MEX function.

`type_obj = coder.typeof(v,sz,variable_dims)` returns a modified copy of `type_obj = coder.typeof(v)` with upper bound size specified by `sz` and variable dimensions specified by `variable_dims`.

`type_obj = coder.typeof(v,'Gpu', true)` creates an object that is derived from `coder.Type` to represent `v` as a GPU input type for code generation. This option requires a valid GPU Coder license.

`type_obj = coder.typeof(type_obj)` returns `type_obj` itself.

Examples

Create Type for a Matrix

Create a type for a simple fixed-size 5x6 matrix of doubles.

```
coder.typeof(ones(5,6))
```

```
ans =
```

```
coder.PrimitiveType
    5x6 double
```

```
coder.typeof(0,[5 6])
```

```
ans =
```

```
coder.PrimitiveType
    5x6 double
```

Create a type for a variable-size matrix of doubles.

```
coder.typeof(ones(3,3), [], 1)

ans =

coder.PrimitiveType
    :3x:3 double
% ':' indicates variable-size dimensions
```

Create a type for a matrix with fixed-size and variable-size dimensions.

```
coder.typeof(0, [2,3,4], [1 0 1])

ans =

coder.PrimitiveType
    :2x3x:4 double

coder.typeof(10, [1 5], 1)

ans =

coder.PrimitiveType
    1x:5 double
% ':' indicates variable-size dimensions
```

Create a type for a matrix of doubles, first dimension unbounded, second dimension with fixed size.

```
coder.typeof(10, [inf, 3])

ans =

coder.PrimitiveType
    :infx3 double
% ':' indicates variable-size dimensions
```

Create a type for a matrix of doubles, first dimension unbounded, second dimension with variable size that has an upper bound of 3.

```
coder.typeof(10, [inf, 3], [0 1])

ans =

coder.PrimitiveType
    :infx:3 double
```

Convert a fixed-size matrix to a variable-size matrix.

```
coder.typeof(ones(5,5), [], 1)

ans =

coder.PrimitiveType
```

```
        :5×:5 double  
% ':' indicates variable-size dimensions
```

Create Type for a Structure

Create a type for a structure with a variable-size field.

```
x.a = coder.typeof(0,[3 5],1);  
x.b = magic(3);  
coder.typeof(x)  
  
ans =  
  
coder.StructType  
  1×1 struct  
    a: :3×:5 double  
    b: 3×3 double  
% ':' indicates variable-size dimensions
```

Create a nested structure (a structure as a field of another structure).

```
S = struct('a',double(0),'b',single(0));  
SuperS.x = coder.typeof(S);  
SuperS.y = single(0);  
coder.typeof(SuperS)  
  
ans =  
  
coder.StructType  
  1×1 struct  
    x: 1×1 struct  
      a: 1×1 double  
      b: 1×1 single  
    y: 1×1 single
```

Create a structure containing a variable-size array of structures as a field.

```
S = struct('a',double(0),'b',single(0));  
SuperS.x = coder.typeof(S,[1 inf],[0 1]);  
SuperS.y = single(0);  
coder.typeof(SuperS)  
  
ans =  
  
coder.StructType  
  1×1 struct  
    x: 1×:inf struct  
      a: 1×1 double  
      b: 1×1 single  
    y: 1×1 single  
% ':' indicates variable-size dimensions
```

Create Type for a Cell Array

Create a type for a homogeneous cell array with a variable-size field.

```

a = coder.typeof(0,[3 5],1);
b = magic(3);
coder.typeof({a b})

ans =

coder.CellType
    1x2 homogeneous cell
        base: :3x:5 double
% ':' indicates variable-size dimensions

```

Create a type for a heterogeneous cell array.

```

a = coder.typeof('a');
b = coder.typeof(1);
coder.typeof({a b})

```

```

ans =

coder.CellType
    1x2 heterogeneous cell
        f1: 1x1 char
        f2: 1x1 double

```

Create a variable-size homogeneous cell array type from a cell array that has the same class but different sizes.

1. Create a type for a cell array that contains two character vectors with different sizes. The cell array type is heterogeneous.

```

coder.typeof({'aa','bbb'})

```

```

ans =

coder.CellType
    1x2 heterogeneous cell
        f1: 1x2 char
        f2: 1x3 char

```

2. Create a type by using the same cell array input. This time, specify that the cell array type has variable-size dimensions. The cell array type is homogeneous.

```

coder.typeof({'aa','bbb'},[1,10],[0,1])

```

```

ans =

coder.CellType
    1x:10 locked homogeneous cell
        base: 1x:3 char
% ':' indicates variable-size dimensions

```

Create Type for a Value Class Object

Change a fixed-size array to a bounded, variable-size array.

Create a type for a value class object.

1. Create this value class:

```
classdef mySquare
    properties
        side;
    end
    methods
        function obj = mySquare(val)
            if nargin > 0
                obj.side = val;
            end
        end
        function a = calcarea(obj)
            a = obj.side * obj.side;
        end
    end
end
```

2. Create an object of mySquare.

```
sq_obj = coder.typeof(mySquare(4))
sq_obj =
coder.ClassType
    1x1 mySquare
        side: 1x1 double
```

3. Create a type for an object that has the same properties as sq_obj.

```
t = coder.typeof(sq_obj)
t =
coder.ClassType
    1x1 mySquare
        side: 1x1 double
```

Alternatively, you can create the type from the class definition:

```
t = coder.typeof(mySquare(4))
t =
coder.ClassType
    1x1 mySquare
        side: 1x1 double
```

Create Type for a String Scalar

Define a string scalar. For example:

```
s = "mystring";
```

Create a type from s.

```
t = coder.typeof(s);
```

To make `t` variable-size, assign the `Value` property of `t` to a type for a variable-size character vector that has the upper bound that you want. For example, specify that type `t` is variable-size with an upper bound of 10.

```
t.Properties.Value = coder.typeof('a',[1 10],[0 1]);
```

To specify that `t` is variable-size and does not have an upper bound:

```
t.Properties.Value = coder.typeof('a',[1 inf]);
```

Pass the type to `codegen` by using the `-args` option.

```
codegen myFunction -args {t}
```

Input Arguments

v — Set of values representing input parameter types

numeric array | character vector | string | struct | cell array

`v` can be a MATLAB numeric, logical, char, enumeration, or fixed-point array. `v` can also be a cell array, structure, or value class that contains the previous types.

When `v` is a cell array whose elements have the same classes but different sizes, if you specify variable-size dimensions, `coder.typeof` creates a homogeneous cell array type. If the elements have different classes, `coder.typeof` reports an error.

Example: `coder.typeof(ones(5,6));`

Data Types: half | single | double | int8 | int16 | int32 | int64 | uint8 | uint16 | uint32 | uint64 | logical | char | string | struct | table | cell | function_handle | categorical | datetime | duration | calendarDuration | fi
Complex Number Support: Yes

sz — Dimension of type object

row vector of integer values

Size vector specifying each dimension of type object.

If `sz` specifies `inf` for a dimension, then the size of the dimension is unbounded and the dimension is variable size. When `sz` is `[]`, the upper bounds of `v` do not change.

If size is not specified, `sz` takes the default dimension of `v`.

Example: `coder.typeof(0,[5,6]);`

Data Types: single | double | int8 | int16 | int32 | int64 | uint8 | uint16 | uint32 | uint64

variable_dims — Variable or fixed dimension

row vector of logical values

Logical vector that specifies whether each dimension is variable size (`true`) or fixed size (`false`). For a cell array, if the elements have different classes, you cannot specify variable-size dimensions.

If you do not specify the `variable_dims` input parameter, the bounded dimensions of the type are fixed.

A scalar `variable_dims` applies to all dimensions. However, if `variable_dims` is 1, the size of a singleton dimension remains fixed.

Example: `coder.typeof(0,[2,3,4],[1 0 1]);`

Data Types: `logical`

type_obj — Type object

`coder.Type` object

`coder.Type` object to represent the type of `v` for code generation.

Example: `type_obj = coder.typeof(ones(5,6));`

Data Types: `single` | `double` | `int8` | `int16` | `int32` | `int64` | `uint8` | `uint16` | `uint32` | `uint64` | `logical` | `char` | `string` | `struct` | `table` | `cell` | `function_handle` | `categorical` | `datetime` | `duration` | `calendarDuration` | `fi`

Complex Number Support: Yes

Output Arguments

type_obj — Type object

`coder.Type` object

`coder.Type` object to represent the type of `v` for code generation.

Example: `type_obj = coder.typeof(ones(5,6));`

Data Types: `single` | `double` | `int8` | `int16` | `int32` | `int64` | `uint8` | `uint16` | `uint32` | `uint64` | `logical` | `char` | `string` | `struct` | `table` | `cell` | `function_handle` | `categorical` | `datetime` | `duration` | `calendarDuration` | `fi`

Complex Number Support: Yes

Limitations

- For sparse matrices, `coder.typeof` drops upper bounds for variable-size dimensions.
- For representing GPU arrays, only bounded numeric and logical base types are supported. Scalar GPU arrays, structures, cell-arrays, classes, enumerated types, character, half-precision and fixed-point data types are not supported.
- When using `coder.typeof` to represent GPU arrays, the memory allocation (`malloc`) mode property of the GPU code configuration object must be set to be `'discrete'`.

Tips

- `coder.typeof` fixes the size of a singleton dimension unless the `variable_dims` argument explicitly specifies that the singleton dimension has a variable size.

For example, the following code specifies a 1-by-:10 double. The first dimension (the singleton dimension) has a fixed size. The second dimension has a variable size.

```
t = coder.typeof(5,[1 10],1)
```

By contrast, this code specifies a :1-by-:10 double. Both dimensions have a variable size.

```
t = coder.typeof(5,[1 10],[1 1])
```

Note For a MATLAB Function block, singleton dimensions of input or output signals cannot have a variable size.

- If you are already specifying the type of an input variable by using a type function, do not use `coder.typeof` unless you also want to specify the size. For instance, instead of `coder.typeof(single(0))`, use the syntax `single(0)`.
- For cell array types, `coder.typeof` determines whether the cell array type is homogeneous or heterogeneous.

If the cell array elements have the same class and size, `coder.typeof` returns a homogeneous cell array type.

If the elements have different classes, `coder.typeof` returns a heterogeneous cell array type.

For some cell arrays, classification as homogeneous or heterogeneous is ambiguous. For example, the type for `{1 [2 3]}` can be a 1x2 heterogeneous type where the first element is double and the second element is 1x2 double. The type can also be a 1x3 homogeneous type in which the elements have class double and size 1x2. For these ambiguous cases, `coder.typeof` uses heuristics to classify the type as homogeneous or heterogeneous. If you want a different classification, use the `coder.CellType` `makeHomogeneous` or `makeHeterogeneous` methods to make a type with the classification that you want. The `makeHomogeneous` method makes a homogeneous copy of a type. The `makeHeterogeneous` method makes a heterogeneous copy of a type.

The `makeHomogeneous` and `makeHeterogeneous` methods permanently assign the classification as heterogeneous and homogeneous. You cannot later use one of these methods to create a copy that has a different classification.

- During code generation with GPU array types, if one input to the entry-point function is of the GPU array type, then the output variables are all GPU array types, provided they are supported for GPU code generation. For example, if the entry-point function returns a `struct` and because `struct` is not supported, the generated code returns a CPU output. However, if a supported matrix type is returned, then the generated code returns a GPU output.

See Also

`coder.ArrayType` | `coder.CellType` | `coder.EnumType` | `coder.FiType` | `coder.PrimitiveType` | `coder.StructType` | `coder.Type` | `coder.newtype` | `coder.resize` | `fiaccel`

Topics

“Define Input Properties by Example at the Command Line”
 “Specify Cell Array Inputs at the Command Line”
 “Specify Objects as Inputs”
 “Define String Scalar Inputs”
 “Create and Edit Input Types by Using the Coder Type Editor”

Introduced in R2011a

coder.unroll

Unroll for-loop by making a copy of the loop body for each loop iteration

Syntax

```
coder.unroll()  
coder.unroll(flag)
```

Description

`coder.unroll()` unrolls a for-loop. The `coder.unroll` call must be on a line by itself immediately preceding the for-loop that it unrolls.

Instead of producing a for-loop in the generated code, loop unrolling produces a copy of the for-loop body for each loop iteration. In each iteration, the loop index becomes constant. To unroll a loop, the code generator must be able to determine the bounds of the for-loop.

For small, tight loops, unrolling can improve performance. However, for large loops, unrolling can increase code generation time significantly and generate inefficient code.

`coder.unroll` is ignored outside of code generation.

`coder.unroll(flag)` unrolls a for-loop if `flag` is `true`. `flag` is evaluated at code generation time. The `coder.unroll` call must be on a line by itself immediately preceding the for-loop that it unrolls.

Examples

Unroll a for-loop

To produce copies of a for-loop body in the generated code, use `coder.unroll`.

In one file, write the entry-point function `call_getrand` and a local function `getrand`. `getrand` unrolls a for-loop that assigns random numbers to an n-by-1 array. `call_getrand` calls `getrand` with the value 3.

```
function z = call_getrand  
%#codegen  
z = getrand(3);  
end
```

```
function y = getrand(n)  
coder.inline('never');  
y = zeros(n, 1);  
coder.unroll();  
for i = 1:n  
    y(i) = rand();  
end  
end
```

Generate a static library.

```
codegen -config:lib call_getrand -report
```

In the generated code, the code generator produces a copy of the for-loop body for each of the three loop iterations.

```
static void getrand(double y[3])
{
    y[0] = b_rand();
    y[1] = b_rand();
    y[2] = b_rand();
}
```

Control for-loop Unrolling with Flag

Control loop unrolling by using `coder.unroll` with the `flag` argument.

In one file, write the entry-point function `call_getrand_unrollflag` and a local function `getrand_unrollflag`. When the number of loop iterations is less than 10, `getrand_unrollflag` unrolls the for-loop. `call_getrand` calls `getrand` with the value 50.

```
function z = call_getrand_unrollflag
    %#codegen
    z = getrand_unrollflag(50);
end

function y = getrand_unrollflag(n)
    coder.inline('never');
    unrollflag = n < 10;
    y = zeros(n, 1);
    coder.unroll(unrollflag)
    for i = 1:n
        y(i) = rand();
    end
end
```

Generate a static library.

```
codegen -config:lib call_getrand_unrollflag -report
```

```
static void getrand_unrollflag(double y[50])
{
    int i;
    for (i = 0; i < 50; i++) {
        y[i] = b_rand();
    }
}
```

The number of iterations is not less than 10. Therefore, the code generator does not unroll the for-loop. It produces a for-loop in the generated code.

Use Legacy Syntax to Unroll for-Loop

- ```
function z = call_getrand
 %#codegen
 z = getrand(3);
end

function y = getrand(n)
 coder.inline('never');
 y = zeros(n, 1);
 for i = coder.unroll(1:n)
 y(i) = rand();
 end
end
```

### Use Legacy Syntax to Control for-Loop Unrolling

- ```
function z = call_getrand_unrollflag
    %#codegen
    z = getrand_unrollflag(50);
end

function y = getrand_unrollflag(n)
    coder.inline('never');
    unrollflag = n < 10;
    y = zeros(n, 1);
    for i = coder.unroll(1:n, unrollflag)
        y(i) = rand();
    end
end
```

Input Arguments

flag — Indicates whether to unroll the for-loop

true (default) | false

When `flag` is `true`, the code generator unrolls the `for`-loop. When `flag` is `false`, the code generator produces a `for`-loop in the generated code. `flag` is evaluated at code generation time.

Tips

- Sometimes, the code generator unrolls a `for`-loop even though you do not use `coder.unroll`. For example, if a `for`-loop indexes into a heterogeneous cell array or into `varargin` or `varargout`, the code generator unrolls the loop. By unrolling the loop, the code generator can determine the value of the index for each loop iteration. The code generator uses heuristics to determine when to unroll a `for`-loop. If the heuristics fail to identify that unrolling is warranted, or if the number of loop iterations exceeds a limit, code generation fails. In these cases, you can force loop unrolling by using `coder.unroll`. See “Nonconstant Index into `varargin` or `varargout` in a `for`-Loop”.

See Also

`coder.inline`

Topics

“Nonconstant Index into varargin or varargout in a for-Loop”

Introduced in R2011a

coder.versize

Package: coder

Declare variable-size data

Syntax

```
coder.versize(varName1,...,varNameN)
coder.versize(varName1,...,varNameN,ubounds)
coder.versize(varName1,...,varNameN,ubounds,dims)
```

Description

`coder.versize(varName1,...,varNameN)` declares that the variables named `varName1,...,varNameN` have a variable size. The declaration instructs the code generator to allow the variables to change size during execution of the generated code. With this syntax, you do not specify the upper bounds of the dimensions of the variables or which dimensions can change size. The code generator computes the upper bounds. All dimensions, except singleton dimensions on page 4-211, are allowed to change size.

Use `coder.versize` according to these restrictions and guidelines:

- Use `coder.versize` inside a MATLAB function intended for code generation.
- The `coder.versize` declaration must precede the first use of a variable. For example:

```
...
x = 1;
coder.versize('x');
disp(size(x));
...
```

- Use `coder.versize` to declare that an output argument has a variable size or to address size mismatch errors. Otherwise, to define variable-size data, use the methods described in “Define Variable-Size Data for Code Generation”.

Note For MATLAB Function blocks, to declare variable-size input or output signals, use the Ports and Data Manager. See “Declare Variable-Size Inputs and Outputs”. If you provide upper bounds in a `coder.versize` declaration, the upper bounds must match the upper bounds in the Ports and Data Manager.

For more restrictions and guidelines, see “Limitations” on page 4-209 and “Tips” on page 4-211.

`coder.versize(varName1,...,varNameN,ubounds)` also specifies an upper bound for each dimension of the variables. All variables must have the same number of dimensions. All dimensions, except singleton dimensions on page 4-211, are allowed to change size.

`coder.versize(varName1,...,varNameN,ubounds,dims)` also specifies an upper bound for each dimension of the variables and whether each dimension has a fixed size or a variable size. If a dimension has a fixed size, then the corresponding `ubound` element specifies the fixed size of the dimension. All variables have the same fixed-size dimensions and the same variable-size dimensions.

Examples

Address Size Mismatch Error by Using `coder.varsize`

After a variable is used (read), changing the size of the variable can cause a size mismatch error. Use `coder.varsize` to specify that the size of the variable can change.

Code generation for the following function produces a size mismatch error because `x = 1:10` changes the size of the second dimension of `x` after the line `y = size(x)` that uses `x`.

```
function [x,y] = usevarsize(n)
%#codegen
x = 1;
y = size(x);
if n > 10
    x = 1:10;
end
```

To declare that `x` can change size, use `coder.varsize`.

```
function [x,y] = usevarsize(n)
%#codegen
x = 1;
coder.varsize('x');
y = size(x);
if n > 10
    x = 1:10;
end
```

If you remove the line `y = size(x)`, you no longer need the `coder.varsize` declaration because `x` is not used before its size changes.

Declare Variable-Size Array with Upper Bounds

Specify that `A` is a row vector whose second dimension has a variable size with an upper bound of 20.

```
function fcn()
...
coder.varsize('A',[1 20]);
...
end
```

When you do not provide `dims`, all dimensions, except singleton dimensions, have a variable size.

Declare Variable-Size Array with a Mix of Fixed and Variable Dimensions

Specify that `A` is an array whose first dimension has a fixed size of three and whose second dimension has a variable size with an upper bound of 20.

```
function fcn()
...
coder.varsize('A',[3 20], [0 1] );
```

```
...  
end
```

Declare Variable-Size Structure Fields

In this function, the statement `coder. varsize('data.values')` declares that the field values inside each element of `data` has a variable size.

```
function y = varsize_field()  
%#codegen  
  
d = struct('values', zeros(1,0), 'color', 0);  
data = repmat(d, [3 3]);  
coder. varsize('data.values');  
  
for i = 1:numel(data)  
    data(i).color = rand-0.5;  
    data(i).values = 1:i;  
end  
  
y = 0;  
for i = 1:numel(data)  
    if data(i).color > 0  
        y = y + sum(data(i).values);  
    end  
end
```

Declare Variable-Size Cell Array

Specify that cell array `C` has a fixed-size first dimension and variable-size second dimension with an upper bound of three. The `coder. varsize` declaration must precede the first use of `C`.

```
...  
C = {1 [1 2]};  
coder. varsize('C', [1 3], [0 1]);  
y = C{1};  
...  
end
```

Without the `coder. varsize` declaration, `C` is a heterogeneous cell array whose elements have the same class and different sizes. With the `coder. varsize` declaration, `C` is a homogeneous cell array whose elements have the same class and maximum size. The first dimension of each element is fixed at 1. The second dimension of each element has a variable size with an upper bound of 3.

Declare That a Cell Array Has Variable-Size Elements

Specify that the elements of cell array `C` are vectors with a fixed-size first dimension and variable-size second dimension with an upper bound of 5.

```
...  
C = {1 2 3};  
coder. varsize('C{:}', [1 5], [0 1]);
```

```
C = {1, 1:5, 2:3};
...
```

Input Arguments

varName1, ..., varNameN — Names of variables to declare as having a variable size
character vectors | string scalars

Names of variables to declare as having a variable size, specified as one or more character vectors or string scalars.

Example: `coder.varsize('x','y')`

ubounds — Upper bounds for array dimensions
[] (default) | vector of integer constants

Upper bounds for array dimensions, specified as a vector of integer constants.

When you do not specify `ubounds`, the code generator computes the upper bound for each variable. If the `ubounds` element corresponds to a fixed-size dimension, the value is the fixed size of the dimension.

Example: `coder.varsize('x','y',[1 2])`

dims — Indication of whether each dimension has a fixed size or a variable size
logical vector

Indication of whether each dimension has a fixed size or a variable size, specified as a logical vector. Dimensions that correspond to 0 or `false` in `dims` have a fixed size. Dimensions that correspond to 1 or `true` have a variable size.

When you do not specify `dims`, the dimensions have a variable size, except for the singleton dimensions.

Example: `coder.varsize('x','y',[1 2], [0 1])`

Limitations

- The `coder.varsize` declaration instructs the code generator to allow the size of a variable to change. It does not change the size of the variable. Consider this code:

```
...
x = 7;
coder.varsize('x', [1,5]);
disp(size(x));
...
```

After the `coder.varsize` declaration, `x` is still a 1-by-1 array. You cannot assign a value to an element beyond the current size of `x`. For example, this code produces a run-time error because the index 3 exceeds the dimensions of `x`.

```
...
x = 7;
coder.varsize('x', [1,5]);
x(3) = 1;
...
```

- `coder.versize` is not supported for a function input argument. Instead:
 - If the function is an entry-point function, specify that an input argument has a variable size by using `coder.typeof` at the command line. Alternatively, specify that an entry-point function input argument has a variable size by using the **Define Input Types** step of the app.
 - If the function is not an entry-point function, use `coder.versize` in the calling function with the variable that is the input to the called function.
- For sparse matrices, `coder.versize` drops upper bounds for variable-size dimensions.
- Limitations for using `coder.versize` with cell arrays:
 - A cell array can have a variable size only if it is homogeneous. When you use `coder.versize` with a heterogeneous cell array, the code generator tries to make the cell array homogeneous. The code generator tries to find a class and maximum size that apply to all elements of the cell array. For example, consider the cell array `c = {1, [2 3]}`. Both elements can be represented by a double type whose first dimension has a fixed size of 1 and whose second dimension has a variable size with an upper bound of 2. If the code generator cannot find a common class and a maximum size, code generation fails. For example, consider the cell array `c = {'a', [2 3]}`. The code generator cannot find a class that can represent both elements because the first element is `char` and the second element is `double`.
 - If you use the `cell` function to define a fixed-size cell array, you cannot use `coder.versize` to specify that the cell array has a variable size. For example, this code causes a code generation error because `x = cell(1,3)` makes `x` a fixed-size,1-by-3 cell array.

```
...
x = cell(1,3);
coder.versize('x',[1 5])
...
```

You can use `coder.versize` with a cell array that you define by using curly braces. For example:

```
...
x = {1 2 3};
coder.versize('x',[1 5])
...
```

- To create a variable-size cell array by using the `cell` function, use this code pattern:

```
function mycell(n)
%#codegen
x = cell(1,n);
for i = 1:n
    x{i} = i;
end
end
```

See “Definition of Variable-Size Cell Array by Using `cell`”.

To specify upper bounds for the cell array, use `coder.versize`.

```
function mycell(n)
%#codegen
x = cell(1,n);
for i = 1:n
    x{i} = i;
coder.versize('x',[1,20]);
end
end
```

```
end
end
```

- `coder.varsize` is not supported for:
 - Global variables
 - MATLAB classes or class properties
 - String scalars

More About

Singleton Dimension

Dimension for which `size(A,dim) = 1`.

Tips

- In a code generation report or a MATLAB Function report, a colon (:) indicates that a dimension has a variable size. For example, a size of `1x:2` indicates that the first dimension has a fixed size of one and the second dimension has a variable size with an upper bound of two.
- If you use `coder.varsize` to specify that the upper bound of a dimension is 1, by default, the dimension has a fixed size of 1. To specify that the dimension can be 0 (empty array) or 1, set the corresponding element of the `dims` argument to `true`. For example, this code specifies that the first dimension of `x` has a fixed size of 1 and the other dimensions have a variable size of 5.

```
coder.varsize('x',[1,5,5])
```

In contrast, this code specifies that the first dimension of `x` has an upper bound of 1 and has a variable size (can be 0 or 1).

```
coder.varsize('x',[1,5,5],[1,1,1])
```

Note For a MATLAB Function block, you cannot specify that an input or output signal with size 1 has a variable size.

- If you use input variables or the result of a computation using input variables to specify the size of an array, it is declared as variable-size in the generated code. Do not re-use `coder.varsize` on the array, unless you also want to specify an upper bound for its size.
- If you do not specify upper bounds with a `coder.varsize` declaration and the code generator is unable to determine the upper bounds, the generated code uses dynamic memory allocation. Dynamic memory allocation can reduce the speed of generated code. To avoid dynamic memory allocation, specify the upper bounds by providing the `ubounds` argument.

See Also

`coder.typeof`

Topics

“Code Generation for Variable-Size Arrays”

“Incompatibilities with MATLAB in Variable-Size Support for Code Generation”

Introduced in R2011a

colon, :

Create vectors, array subscripting

Syntax

```
y = j:k
y = j:i:k
```

Description

`y = j:k` returns a regularly-spaced vector, `[j, j+1, ..., k]`. `j:k` is empty when `j > k`.

At least one of the colon operands must be a `fi` object. All colon operands must have integer values. All the fixed-point operands must be binary-point scaled. Slope-bias scaling is not supported. If any of the operands is complex, the `colon` function generates a warning and uses only the real part of the operands.

`y = colon(j,k)` is the same as `y = j:k`.

`y = j:i:k` returns a regularly-spaced vector, `[j, j+i, j+2i, ..., j+m*i]`, where `m = fix((k-j)/i)`. `y = j:i:k` returns an empty matrix when `i == 0`, `i > 0` and `j > k`, or `i < 0` and `j < k`.

Examples

Use `fi` as a Colon Operator

When you use `fi` as a colon operator, all colon operands must have integer values.

```
a = fi(1,0,3,0);
b = fi(2,0,8,0);
c = fi(12,0,8,0);
x = a:b:c
```

```
x=1x6 object
```

```
    1     3     5     7     9    11
```

```
    DataTypeMode: Fixed-point: binary point scaling
    Signedness: Unsigned
    WordLength: 8
    FractionLength: 0
```

Because all the input operands are unsigned, `x` is unsigned and the word length is 8. The fraction length of the resulting vector is always 0.

Use the colon Operator With Signed and Unsigned Operands

```
a = fi(int8(-1));
b = uint8(255);
```

```

c = a:b;
len = c.WordLength

len = 9

signedness = c.Signedness

signedness =
'Signed'

```

The word length of `c` requires an additional bit to handle the intersection of the ranges of `int8` and `uint8`. The data type of `c` is signed because the operand `a` is signed.

Create a Vector of Decreasing Values

If the beginning and ending operands are unsigned, the increment operand can be negative.

```

x = fi(4,false):-1:1
x=1x4 object
   4   3   2   1
      DataTypeMode: Fixed-point: binary point scaling
      Signedness: Unsigned
      WordLength: 16
      FractionLength: 0

```

Use the colon Operator With Floating-Point and fi Operands

If any of the operands is floating-point, the output has the same word length and signedness as the `fi` operand

```

x = fi(1):10
x=1x10 object
   1   2   3   4   5   6   7   8   9   10
      DataTypeMode: Fixed-point: binary point scaling
      Signedness: Signed
      WordLength: 16
      FractionLength: 0

```

`x = fi(1):10` is equivalent to `fi(1:10, true, 16, 0)` so `x` is signed and its word length is 16 bits.

Rewrite Code That Uses Non-Integer Operands

If your code uses non-integer operands, rewrite the colon expression so that the operands are integers.

The following code does not work because the colon operands are not integer values.

```
Fs = fi(100);  
n = 1000;  
t = (0:1/Fs:(n/Fs - 1/Fs));
```

Rewrite the colon expression to use integer operands.

```
Fs = fi(100);  
n = 1000;  
t = (0:(n-1))/Fs;
```

All Colon Operands Must Be in the Range of the Data Type

If the value of any of the colon operands is outside the range of the data type used in the colon expression, MATLAB generates an error.

```
y = fi(1,true,8,0):256
```

MATLAB generates an error because 256 is outside the range of `fi(1,true,8,0)`. This behavior matches the behavior for built-in integers. For example, `y = int8(1):256` generates the same error.

Input Arguments

j — Beginning operand

real scalar

Beginning operand, specified as a real scalar integer-valued `fi` object or built-in numeric type.

If you specify non-scalar arrays, MATLAB interprets `j:i:k` as `j(1):i(1):k(1)`.

Data Types: `fi` | `single` | `double` | `int8` | `int16` | `int32` | `int64` | `uint8` | `uint16` | `uint32` | `uint64`

i — Increment

1 (default) | real scalar

Increment, specified as a real scalar integer-valued `fi` object or built-in numeric type. Even if the beginning and end operands, `j` and `k`, are both unsigned, the increment operand `i` can be negative.

Data Types: `fi` | `single` | `double` | `int8` | `int16` | `int32` | `int64` | `uint8` | `uint16` | `uint32` | `uint64`

k — Ending operand

real scalar

Ending operand, specified as a real scalar integer-valued `fi` object or built-in numeric type.

Data Types: `fi` | `single` | `double` | `int8` | `int16` | `int32` | `int64` | `uint8` | `uint16` | `uint32` | `uint64`

Output Arguments

y — Regularly-spaced vector

real vector

Fixed-Point Designer determines the data type of the **y** using the following rules:

- The data type covers the union of the ranges of the fixed-point types of the input operands.
- If either the beginning or ending operand is signed, the resulting data type is signed. Otherwise, the resulting data type is unsigned.
- The word length of **y** is the smallest value such that the fraction length is 0 and the real-world value of the least-significant bit is 1.
- If any of the operands is floating-point, the word length and signedness of **y** is derived from the **fi** operand.
- If any of the operands is a scaled double, **y** is a scaled double.
- The **fimath** of **y** is the same as the **fimath** of the input operands.
- If all the **fi** objects are of data type **double**, the data type of **y** is **double**. If all the **fi** objects are of data type **single**, the data type of **y** is **single**. If there are both **double** and **single** inputs, and no fixed-point inputs, the output data type is **single**.

See Also

colon | **fi**

Introduced in R2013b

complex

Construct complex `fi` object from real and imaginary parts

Syntax

```
c = complex(a,b)
c = complex(x)
```

Description

`c = complex(a,b)` creates a complex output, `c`, from two real inputs, such that $c = a + bi$.

When `b` is all zero, `c` is complex with an all-zero imaginary part. This is in contrast to the addition of `a + 0i`, which returns a strictly real result.

`c = complex(x)` returns the complex equivalent of `x`, such that `isreal(c)` returns logical `0` (`false`).

- If `x` is real, then `c` is $x + 0i$.
- If `x` is complex, then `c` is identical to `x`.

Examples

Complex Scalar from Two Real Scalars

Use the `complex` function to create the complex scalar, $3 + 4i$.

```
a = fi(3,1,16,12);
b = fi(4,0,8);
c = complex(a,b)
```

```
c =
```

```
3.0000 + 4.0000i
```

```
    DataTypeMode: Fixed-point: binary point scaling
      Signedness: Signed
      WordLength: 16
    FractionLength: 12
```

The output, `c`, has the same `numericType` and `fimath` properties as the input `fi` object, `a`.

Complex Vector from One Real Vector

Create a complex `fi` vector with a zero imaginary part.

```
x = fi([1;2;3;4]);
c = complex(x)
```

```

c =
    1.0000 + 0.0000i
    2.0000 + 0.0000i
    3.0000 + 0.0000i
    4.0000 + 0.0000i

    DataTypeMode: Fixed-point: binary point scaling
    Signedness: Signed
    WordLength: 16
    FractionLength: 12

```

Verify that `c` is complex.

```
isreal(c)
```

```
ans =
```

```

logical
    0

```

Input Arguments

a — Real component

scalar | vector | matrix | multidimensional array

Real component, specified as a `fi` scalar, vector, matrix, or multidimensional array.

The size of `a` must match the size of `b`, unless one is a scalar. If either `a` or `b` is a scalar, MATLAB expands the scalar to match the size of the other input.

Data Types: `fi`

b — Imaginary component

scalar | vector | matrix | multidimensional array

Imaginary component, specified as a `fi` scalar, vector, matrix, or multidimensional array.

The size of `b` must match the size of `a`, unless one is a scalar. If either `a` or `b` is a scalar, MATLAB expands the scalar to match the size of the other input.

Data Types: `fi`

x — Input array

scalar | vector | matrix | multidimensional array

Input array, specified as a `fi` scalar, vector, matrix, or multidimensional array.

Data Types: `fi`

Output Arguments

c — Complex array

scalar | vector | matrix | multidimensional array

Complex array, returned as a `fi` scalar, vector, matrix, or multidimensional array.

The size of `c` is the same as the input arguments.

The output `fi` object, `c`, has the same `numericType` and `fimath` properties as the input `fi` object, `a`.

Extended Capabilities

C/C++ Code Generation

Generate C and C++ code using MATLAB® Coder™.

HDL Code Generation

Generate Verilog and VHDL code for FPGA and ASIC designs using HDL Coder™.

See Also

`fi` | `fimath` | `numericType`

Introduced before R2006a

conj

Complex conjugate of `fi` object

Syntax

`conj(a)`

Description

`conj(a)` is the complex conjugate of `fi` object `a`.

When `a` is complex,

$$\text{conj}(a) = \text{real}(a) - i \times \text{imag}(a)$$

The `numericType` and `fiMath` properties associated with the input `a` are applied to the output.

Extended Capabilities

C/C++ Code Generation

Generate C and C++ code using MATLAB® Coder™.

HDL Code Generation

Generate Verilog and VHDL code for FPGA and ASIC designs using HDL Coder™.

See Also

`complex`

Introduced before R2006a

conv

Convolution and polynomial multiplication of `fi` objects

Syntax

```
c = conv(a,b)
c = conv(a,b,shape)
```

Description

`c = conv(a,b)` returns the convolution of input vectors `a` and `b`, at least one of which must be a `fi` object.

`c = conv(a,b,shape)` returns a subsection of the convolution, as specified by `shape`.

Examples

Convolution of 22-Sample Sequence with 16-Tap FIR Filter

Find the convolution of a 22-sample sequence with a 16-tap FIR filter.

`x` is a 22-sample sequence of signed values with a word length of 16 bits and a fraction length of 15 bits. `h` is the 16-tap FIR filter.

```
u = (pi/4)*[1 1 1 -1 -1 -1 1 -1 -1 1 -1];
x = fi(kron(u,[1 1]));
h = firls(15, [0 .1 .2 .5]*2, [1 1 0 0]);
```

Because `x` is a `fi` object, you do not need to cast `h` into a `fi` object before performing the convolution operation. The `conv` function does this automatically using best-precision scaling.

Use the `conv` function to convolve the two vectors.

```
y = conv(x,h);
```

The operation results in a signed `fi` object `y` with a word length of 36 bits and a fraction length of 31 bits. The default `fimath` properties associated with the inputs determine the `numericType` of the output. The output does not have a local `fimath`.

Central Part of Convolution of Two `fi` Vectors

Create two `fi` vectors. Find the central part of the convolution of `a` and `b` that is the same size as `a`.

```
a = fi([-1 2 3 -2 0 1 2]);
b = fi([2 4 -1 1]);
c = conv(a,b,'same')
c =
```

```
15    5    -9    7    6    7    -1
```

```
    DataTypeMode: Fixed-point: binary point scaling
    Signedness: Signed
    WordLength: 34
    FractionLength: 25
```

`c` has a length of 7. The full convolution would be of length $\text{length}(a) + \text{length}(b) - 1$, which in this example would be 10.

Input Arguments

a, b — Input vectors

vectors

Input vectors, specified as either row or column vectors.

If either input is a built-in data type, `conv` casts it into a `fi` object using best-precision rules before the performing the convolution operation.

Data Types: `single` | `double` | `int8` | `int16` | `int32` | `int64` | `uint8` | `uint16` | `uint32` | `uint64` | `fi`

Complex Number Support: Yes

shape — Subset of convolution

'full' (default) | 'same' | 'valid'

Subset of convolution, specified as one of these values:

- 'full' — Returns the full convolution. This option is the default shape.
- 'same' — Returns the central part of the convolution that is the same size as input vector `a`.
- 'valid' — Returns only those parts of the convolution that the function computes without zero-padded edges. Using this option, the length of output vector `c` is $\max(\text{length}(a) - \max(0, \text{length}(b) - 1), 0)$.

Data Types: `char`

More About

Convolution

The convolution of two vectors, `u` and `v`, represents the area of overlap under the points as `v` slides across `u`. Algebraically, convolution is the same operation as multiplying polynomials whose coefficients are the elements of `u` and `v`.

Let $m = \text{length}(u)$ and $n = \text{length}(v)$. Then `w` is the vector of length $m+n-1$ whose k th element is

The sum is over all the values of `j` that lead to legal subscripts for `u(j)` and `v(k-j+1)`, specifically $j = \max(1, k+1-n) : 1 : \min(k, m)$. When $m = n$, this gives

$$\begin{aligned} w(1) &= u(1)*v(1) \\ w(2) &= u(1)*v(2)+u(2)*v(1) \end{aligned}$$

$$\begin{aligned}w(3) &= u(1)*v(3)+u(2)*v(2)+u(3)*v(1) \\ \dots \\ w(n) &= u(1)*v(n)+u(2)*v(n-1)+ \dots +u(n)*v(1) \\ \dots \\ w(2*n-1) &= u(n)*v(n)\end{aligned}$$

Algorithms

The `fimath` properties associated with the inputs determine the `numericType` properties of output `fi` object `c`:

- If either `a` or `b` has a local `fimath` object, `conv` uses that `fimath` object to compute intermediate quantities and determine the `numericType` properties of `c`.
- If neither `a` nor `b` have an attached `fimath`, `conv` uses the default `fimath` to compute intermediate quantities and determine the `numericType` properties of `c`.

If either input is a built-in data type, `conv` casts it into a `fi` object using best-precision rules before the performing the convolution operation.

The output `fi` object `c` always uses the default `fimath`.

Extended Capabilities

C/C++ Code Generation

Generate C and C++ code using MATLAB® Coder™.

Usage notes and limitations:

- Variable-sized inputs are only supported when the `SumMode` property of the governing `fimath` is set to `SpecifyPrecision` or `KeepLSB`.
- For variable-sized signals, you might see different results between generated code and MATLAB.
 - In the generated code, the output for variable-sized signals is computed using the `SumMode` property of the governing `fimath`.
 - In MATLAB, the output for variable-sized signals is computed using the `SumMode` property of the governing `fimath` when both inputs are nonscalar. However, if either input is a scalar, MATLAB computes the output using the `ProductMode` of the governing `fimath`.

See Also

`conv`

Introduced in R2009b

convergent

Round toward nearest integer with ties rounding to nearest even integer

Syntax

```
y = convergent(a)
y = convergent(x)
```

Description

`y = convergent(a)` rounds `fi` object `a` to the nearest integer. In the case of a tie, `convergent(a)` rounds to the nearest even integer.

`y = convergent(x)` rounds the elements of `x` to the nearest integer. In the case of a tie, `convergent(x)` rounds to the nearest even integer.

Examples

Use Convergent Rounding on Signed `fi` Object

The following example demonstrates how the `convergent` function affects the `numericType` properties of a signed `fi` object with a word length of 8 and a fraction length of 3.

```
a = fi(pi,1,8,3)
a =
    3.1250

    DataTypeMode: Fixed-point: binary point scaling
    Signedness: Signed
    WordLength: 8
    FractionLength: 3

y = convergent(a)
y =
    3

    DataTypeMode: Fixed-point: binary point scaling
    Signedness: Signed
    WordLength: 6
    FractionLength: 0
```

The following example demonstrates how the `convergent` function affects the `numericType` properties of a signed `fi` object with a word length of 8 and a fraction length of 12.

```
a = fi(0.025,1,8,12)
a =
    0.0249
```

```

        DataTypeMode: Fixed-point: binary point scaling
        Signedness: Signed
        WordLength: 8
        FractionLength: 12

```

```
y = convergent(a)
```

```
y =
    0
```

```

        DataTypeMode: Fixed-point: binary point scaling
        Signedness: Signed
        WordLength: 2
        FractionLength: 0

```

Compare Rounding Methods

The functions `convergent`, `nearest`, and `round` differ in the way they treat values whose least significant digit is 5.

- The `convergent` function rounds ties to the nearest even integer.
- The `nearest` function rounds ties to the nearest integer toward positive infinity.
- The `round` function rounds ties to the nearest integer with greater absolute value.

This example illustrates these differences for a given input, `a`.

```
a = fi([-3.5:3.5]');
y = [a convergent(a) nearest(a) round(a)]
```

```

y=8x4 object
   -3.5000   -4.0000   -3.0000   -4.0000
   -2.5000   -2.0000   -2.0000   -3.0000
   -1.5000   -2.0000   -1.0000   -2.0000
   -0.5000         0         0     -1.0000
    0.5000         0    1.0000    1.0000
    1.5000    2.0000    2.0000    2.0000
    2.5000    2.0000    3.0000    3.0000
    3.5000    3.9999    3.9999    3.9999

```

```

        DataTypeMode: Fixed-point: binary point scaling
        Signedness: Signed
        WordLength: 16
        FractionLength: 13

```

Input Arguments

a — Input `fi` array

scalar | vector | matrix | multidimensional array

Input `fi` array, specified as scalar, vector, matrix, or multidimensional array.

For complex `fi` objects, the imaginary and real parts are rounded independently.

`convergent` does not support `fi` objects with nontrivial slope and bias scaling. Slope and bias scaling is trivial when the slope is an integer power of 2 and the bias is 0.

Data Types: `fi`

Complex Number Support: Yes

x — Input array

scalar | vector | matrix | multidimensional array

Input array, specified as a scalar, vector, matrix, or multidimensional array.

For complex inputs, the real and imaginary parts are rounded independently.

Data Types: `single` | `double` | `int8` | `int16` | `int32` | `int64` | `uint8` | `uint16` | `uint32` | `uint64`

Complex Number Support: Yes

Algorithms

- `y` and `a` have the same `fi` object and `DataType` property.
- When the `DataType` property of `a` is `single`, or `double`, the `numericType` of `y` is the same as that of `a`.
- When the fraction length of `a` is zero or negative, `a` is already an integer, and the `numericType` of `y` is the same as that of `a`.
- When the fraction length of `a` is positive, the fraction length of `y` is 0, its sign is the same as that of `a`, and its word length is the difference between the word length and the fraction length of `a`, plus one bit. If `a` is signed, then the minimum word length of `y` is 2. If `a` is unsigned, then the minimum word length of `y` is 1.

Extended Capabilities

C/C++ Code Generation

Generate C and C++ code using MATLAB® Coder™.

HDL Code Generation

Generate Verilog and VHDL code for FPGA and ASIC designs using HDL Coder™.

See Also

`ceil` | `fix` | `floor` | `nearest` | `round`

Topics

“Precision and Range”

Introduced before R2006a

convertToSingle

Convert double-precision MATLAB code to single-precision MATLAB code

Syntax

```
convertToSingle options fcn_1, ..., fcn_n  
convertToSingle options fcn_1, -args args_1 ,..., fcn_n -args args_n
```

Description

`convertToSingle options fcn_1, ..., fcn_n` generates single-precision MATLAB code from the specified function or functions. When you use this syntax, you must provide a test file that `convertToSingle` can use to determine the properties of the input parameters. To specify the test file, use `coder.config('single')` to create a `coder.SingleConfig` object. Specify the `TestBenchName` property.

`convertToSingle options fcn_1, -args args_1 ,..., fcn_n -args args_n` specifies the properties of the input arguments.

Examples

Convert to Single Precision and Validate Using a Test File

Generate single-precision code from a double-precision function `myfun.m`. Specify a test file for determining the argument properties and for verification of the converted types. Plot the error between the double-precision and single-precision values.

```
scfg = coder.config('single');  
scfg.TestBenchName = 'myfun_test';  
scfg.TestNumerics = true;  
scfg.LogIOForComparisonPlotting = true;  
convertToSingle -config scfg myfun
```

Convert Multiple Functions to Single Precision with the Default Configuration

Convert `myfun1.m` and `myfun2.m` to single precision. Specify that `myfun1` has a double scalar argument and `myfun2` has a 2x3 double argument.

```
convertToSingle -config cfg myfun1 -args {0} myfun2 -args {zeros(2, 3)}
```

Specify Input Argument Properties

Generate single-precision code from a double-precision function, `myfun.m`, whose first argument is double scalar and whose second argument is 2x3 double.

```
convertToSingle myfun -args {0, zeros(2, 3)}
```

Input Arguments

fcn — Function name

character vector

MATLAB function from which to generate single-precision code.

args — Argument properties

cell array of types or example values.

Definition of the size, class, and complexity of the input arguments specified as a cell array of types or example values. To create a type, use `coder.typeof`.

options — options for single-precision conversion

`-config` | `-globals`

Specify one of the following single-conversion options.

`-config` *config_object*

Specify the configuration object to use for conversion of double-precision MATLAB code to single-precision MATLAB code. To create the configuration object, use

```
coder.config('single');
```

If you do not use this option, the conversion uses a default configuration. When you omit `-config`, to specify the properties of the input arguments, use `-args`.

`-globals global_values`

Specify names and initial values for global variables in MATLAB files.

`global_values` is a cell array of global variable names and initial values. The format of `global_values` is:

```
{g1, init1, g2, init2, ..., gn, initn}
```

`gn` is the name of a global variable. `initn` is the initial value. For example:

```
-globals {'g', 5}
```

Alternatively, use this format:

```
-globals {global_var, {type, initial_value}}
```

`type` is a type object. To create the type object, use `coder.typeof`.

If you do not provide initial values for global variables using the `-globals` option, `convertToSingle` checks for the variable in the MATLAB global workspace. If you do not supply an initial value, `convertToSingle` generates an error.

See Also

`coder.SingleConfig` | `coder.config`

Topics

“Generate Single-Precision MATLAB Code”

Introduced in R2015b

copyobj

Make independent copy of quantizer object

Syntax

```
q1 = copyobj(q)
[q1,q2,...] = copyobj(obja,objb,...)
```

Description

`q1 = copyobj(q)` makes a copy of quantizer object `q` and returns it in `q1`.

`[q1,q2,...] = copyobj(obja,objb,...)` copies `obja` into `q1`, `objb` into `q2`, and so on.

Using `copyobj` to copy a quantizer object is not the same as using the command syntax `q1 = q` to copy a quantizer object. Quantizer objects have memory (their read-only properties). When you use `copyobj`, the resulting copy is independent of the original item; it does not share the original object's memory, such as the values of the properties `min`, `max`, `noverflows`, or `noperations`. Using `q1 = q` creates a new object that is an alias for the original and shares the original object's memory, and thus its property values.

Examples

```
q = quantizer([8 7]);
q1 = copyobj(q)
```

See Also

[get](#) | [quantizer](#) | [set](#)

Introduced before R2006a

cordicabs

CORDIC-based absolute value

Syntax

```
r = cordicabs(c)
r = cordicabs(c,niters)
r = cordicabs(c,niters,'ScaleOutput',b)
r = cordicabs(c,'ScaleOutput',b)
```

Description

`r = cordicabs(c)` returns the magnitude of the complex elements of `C`.

`r = cordicabs(c,niters)` performs `niters` iterations of the algorithm.

`r = cordicabs(c,niters,'ScaleOutput',b)` specifies both the number of iterations and, depending on the Boolean value of `b`, whether to scale the output by the inverse CORDIC gain value.

`r = cordicabs(c,'ScaleOutput',b)` scales the output depending on the Boolean value of `b`.

Input Arguments

c

`c` is a vector of complex values.

niters

`niters` is the number of iterations the CORDIC algorithm performs. This argument is optional. When specified, `niters` must be a positive, integer-valued scalar. If you do not specify `niters`, or if you specify a value that is too large, the algorithm uses a maximum value. For fixed-point operation, the maximum number of iterations is the word length of `r` or one less than the word length of `theta`, whichever is smaller. For floating-point operation, the maximum value is 52 for double or 23 for single. Increasing the number of iterations can produce more accurate results but also increases the expense of the computation and adds latency.

Name-Value Pair Arguments

Optional comma-separated pairs of `Name,Value` arguments, where `Name` is the argument name and `Value` is the corresponding value. `Name` must appear inside single quotes (' ').

ScaleOutput

`ScaleOutput` is a Boolean value that specifies whether to scale the output by the inverse CORDIC gain factor. This argument is optional. If you set `ScaleOutput` to `true` or `1`, the output values are multiplied by a constant, which incurs extra computations. If you set `ScaleOutput` to `false` or `0`, the output is not scaled.

Default: `true`

Output Arguments

r

r contains the magnitude values of the complex input values. If the inputs are fixed-point values, **r** is also fixed point (and is always signed, with binary point scaling). All input values must have the same data type. If the inputs are signed, then the word length of **r** is the input word length + 2. If the inputs are unsigned, then the word length of **r** is the input word length + 3. The fraction length of **r** is always the same as the fraction length of the inputs.

Examples

Compare `cordicabs` and `abs` of double values.

```
dblValues = complex(rand(5,4),rand(5,4));
r_dbl_ref = abs(dblValues)
r_dbl_cdc = cordicabs(dblValues)
```

Compute absolute values of fixed-point inputs.

```
fxpValues = fi(dblValues);
r_fxp_cdc = cordicabs(fxpValues)
```

More About

CORDIC

CORDIC is an acronym for COordinate Rotation DIGital Computer. The Givens rotation-based CORDIC algorithm is one of the most hardware-efficient algorithms available because it requires only iterative shift-add operations (see References). The CORDIC algorithm eliminates the need for explicit multipliers. Using CORDIC, you can calculate various functions such as sine, cosine, arc sine, arc cosine, arc tangent, and vector magnitude. You can also use this algorithm for divide, square root, hyperbolic, and logarithmic functions.

Increasing the number of CORDIC iterations can produce more accurate results, but doing so increases the expense of the computation and adds latency.

More About

[1] Volder, JE. "The CORDIC Trigonometric Computing Technique." *IRE Transactions on Electronic Computers*. Vol. EC-8, September 1959, pp. 330-334.

[2] Andraka, R. "A survey of CORDIC algorithm for FPGA based computers." *Proceedings of the 1998 ACM/SIGDA sixth international symposium on Field programmable gate arrays*. Feb. 22-24, 1998, pp. 191-200.

[3] Walther, J.S. "A Unified Algorithm for Elementary Functions." Hewlett-Packard Company, Palo Alto. Spring Joint Computer Conference, 1971, pp. 379-386. (from the collection of the Computer History Museum). www.computer.org/csdl/proceedings/afips/1971/5077/00/50770379.pdf

[4] Schelin, Charles W. "Calculator Function Approximation." *The American Mathematical Monthly*. Vol. 90, No. 5, May 1983, pp. 317-325.

Algorithms

Signal Flow Diagrams

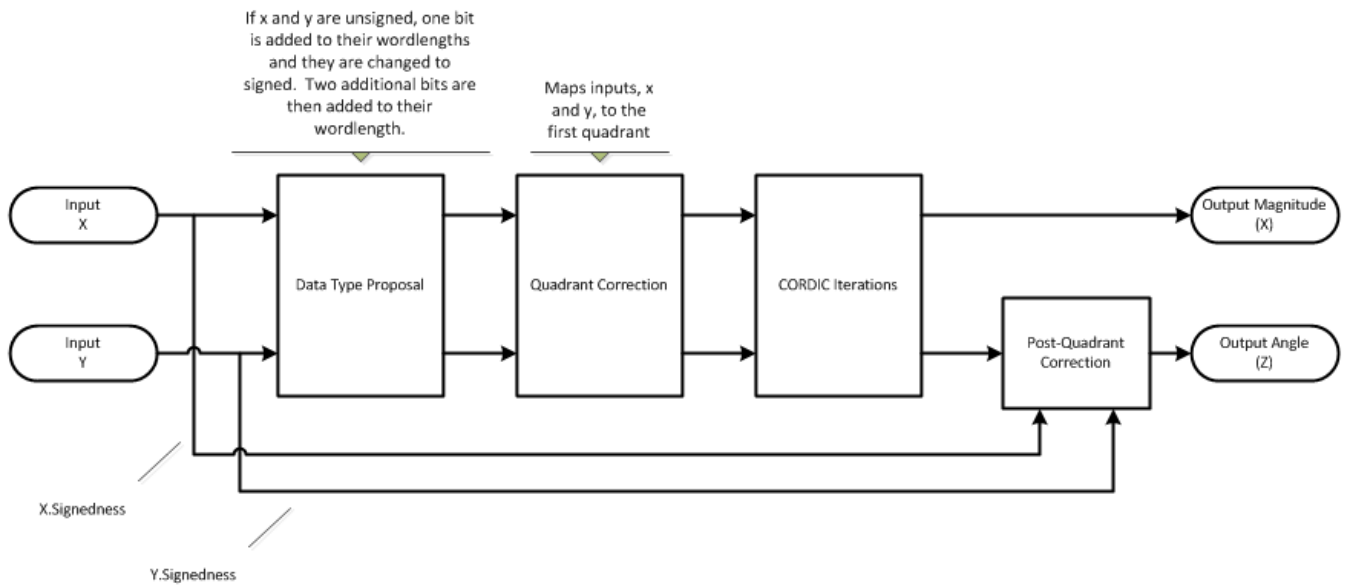

CORDIC Vectorsing Kernel

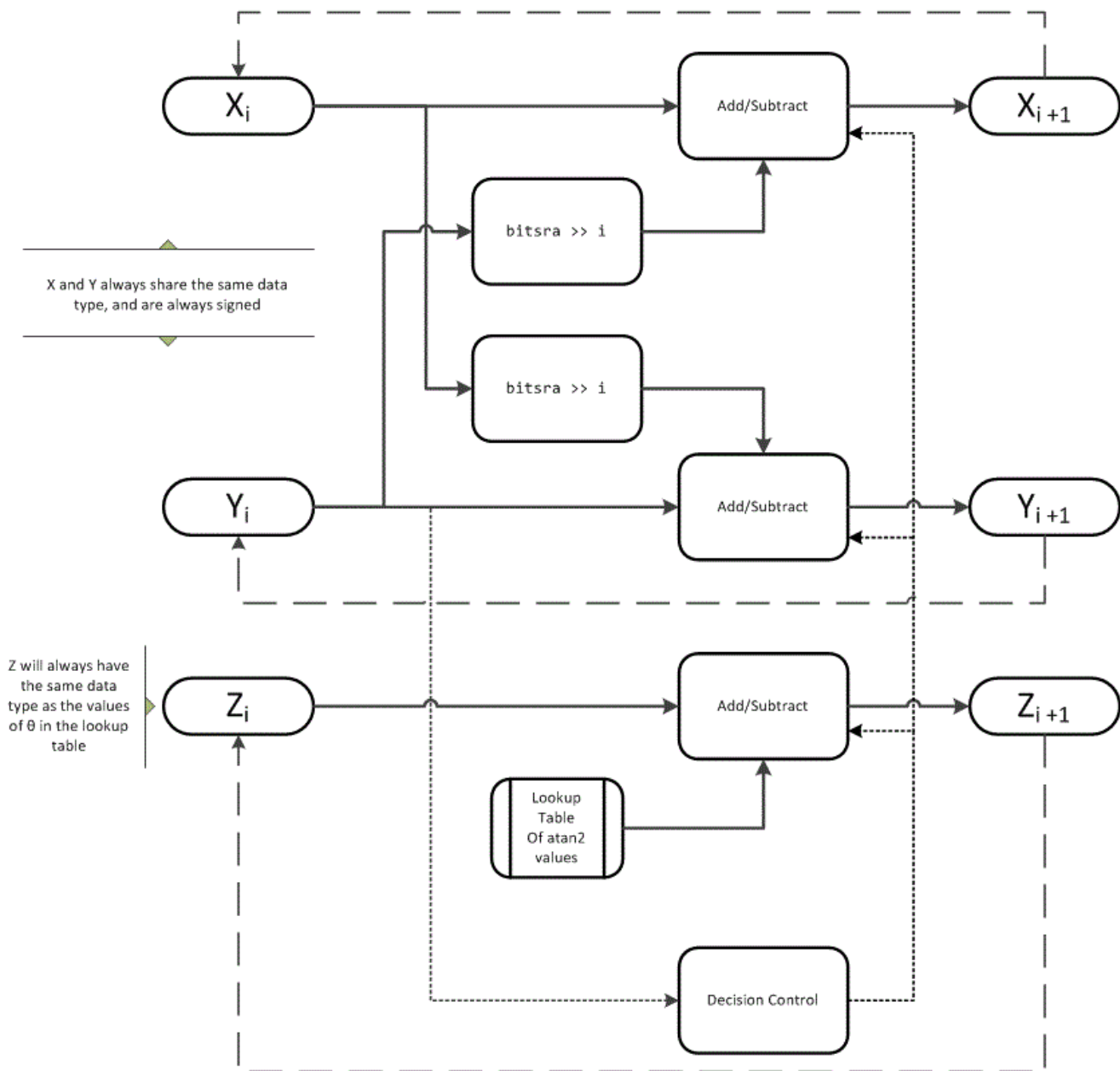

The accuracy of the CORDIC kernel depends on the choice of initial values for X , Y , and Z . This algorithm uses the following initial values:

- x_0 is initialized to the x input value
- y_0 is initialized to the y input value
- z_0 is initialized to 0

fimath Propagation Rules

CORDIC functions discard any local `fimath` attached to the input.

The CORDIC functions use their own internal `fimath` when performing calculations:

- `OverflowAction`—`Wrap`
- `RoundingMethod`—`Floor`

The output has no attached `fimath`.

Extended Capabilities**C/C++ Code Generation**

Generate C and C++ code using MATLAB® Coder™.

Usage notes and limitations:

- Variable-size signals are not supported.
- The number of iterations the CORDIC algorithm performs, `nIters`, must be a constant.

See Also

`abs` | `cordicangle` | `cordiccart2pol`

Introduced in R2011b

cordicacos

CORDIC-based approximation of inverse cosine

Syntax

```
theta = cordicacos(x)
theta = cordicacos(x, niters)
```

Description

`theta = cordicacos(x)` returns the inverse cosine of `x` based on a CORDIC approximation.

`theta = cordicacos(x, niters)` returns the inverse cosine of `x` performing `niters` iterations of the CORDIC algorithm.

Examples

Calculate CORDIC Inverse Cosine

Compute the inverse cosine of a fixed-point `fi` object using a CORDIC implementation.

```
a = fi(-1:.1:1,1,16);
b = cordicacos(a);
plot(a,b);
title('Inverse CORDIC Cosine');
```

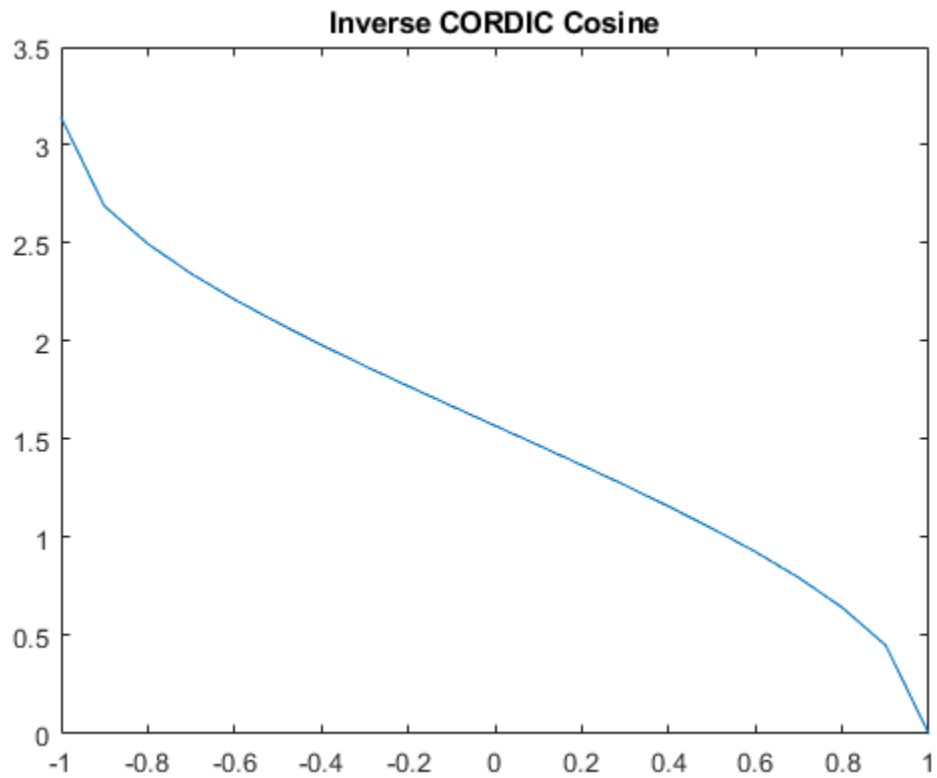

Compare the output of the `cordicacos` function and the `acos` function.

```
c = acos(double(a));  
error = double(b)-c;  
plot(a,error);  
title('Error');
```

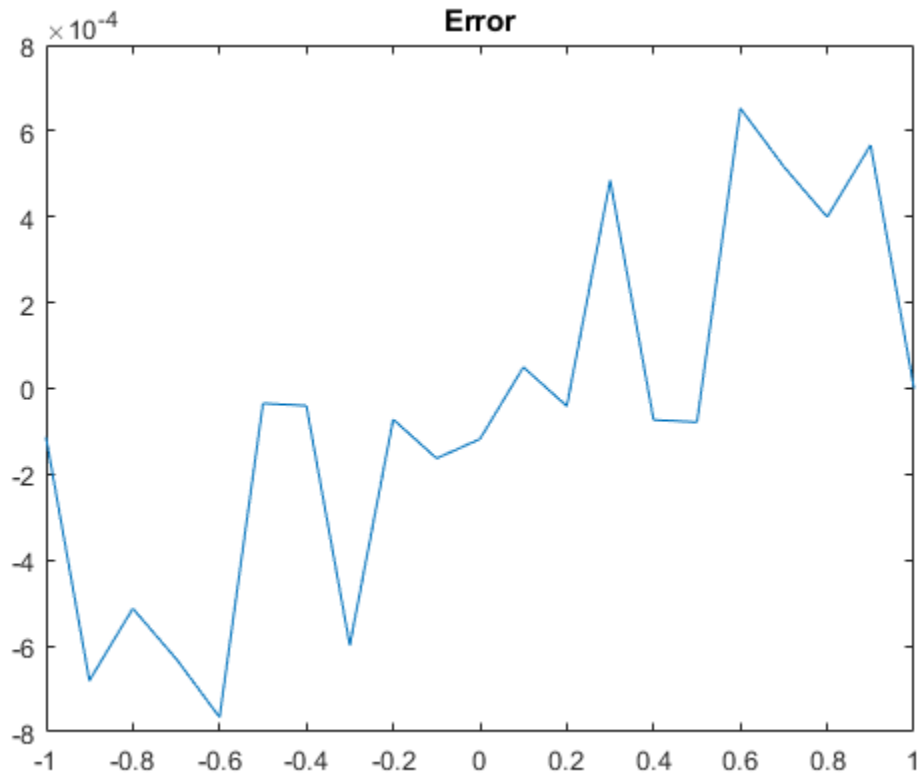

Calculate CORDIC Inverse Cosine with Specified Number of Iterations

Find the inverse cosine of a `fi` object using a CORDIC implementation and specify the number of iterations the CORDIC kernel should perform. Plot the CORDIC approximation of the inverse cosine with varying numbers of iterations.

```
a = fi(-1:.1:1, 1, 16);
for i = 5:5:20
    b = cordicacos(a,i);
    plot(a,b);
    hold on;
end
legend('5 iterations', '10 iterations', '15 iterations', '20 iterations')
```

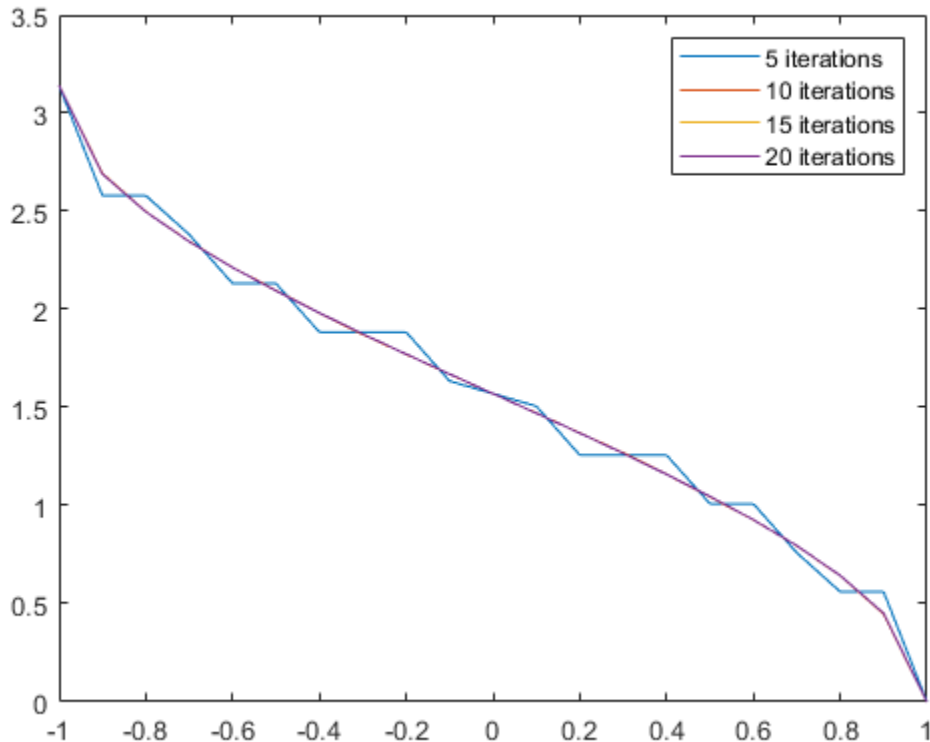

Input Arguments

x — Numeric input

scalar | vector | matrix | multidimensional array

Numeric input, specified as a scalar, vector, matrix, or multidimensional array.

Data Types: single | double | int8 | int16 | int32 | int64 | uint8 | uint16 | uint32 | uint64 | fi

Complex Number Support: Yes

niters — Number of iterations

scalar

The number of iterations that the CORDIC algorithm performs, specified as a positive, integer-valued scalar. If you do not specify `niters`, the algorithm uses a default value. For fixed-point inputs, the default value of `niters` is one less than the word length of the input array, `theta`. For double-precision inputs, the default value of `niters` is 52. For single-precision inputs, the default value is 23.

Data Types: single | double | int8 | int16 | int32 | int64 | uint8 | uint16 | uint32 | uint64 | fi

Output Arguments

theta — Inverse cosine angle values

scalar | vector | matrix | n-dimensional array

Inverse cosine angle values in rad.

See Also

Functions

cordiccos | cordicsin

Introduced in R2018b

cordicangle

CORDIC-based phase angle

Syntax

```
theta = cordicangle(c)
theta = cordicangle(c,niters)
```

Description

`theta = cordicangle(c)` returns the phase angles, in radians, of matrix `c`, which contains complex elements.

`theta = cordicangle(c,niters)` performs `niters` iterations of the algorithm.

Input Arguments

c

Matrix of complex numbers

niters

`niters` is the number of iterations the CORDIC algorithm performs. This argument is optional. When specified, `niters` must be a positive, integer-valued scalar. If you do not specify `niters`, or if you specify a value that is too large, the algorithm uses a maximum value. For fixed-point operation, the maximum number of iterations is the word length of `r` or one less than the word length of `theta`, whichever is smaller. For floating-point operation, the maximum value is 52 for double or 23 for single. Increasing the number of iterations can produce more accurate results but also increases the expense of the computation and adds latency.

Output Arguments

theta

`theta` contains the polar coordinates angle values, which are in the range $[-\pi, \pi]$ radians. If `x` and `y` are floating-point, then `theta` has the same data type as `x` and `y`. Otherwise, `theta` is a fixed-point data type with the same word length as `x` and `y` and with a best-precision fraction length for the $[-\pi, \pi]$ range.

Examples

Phase angle for double-valued input and for fixed-point-valued input.

```
dblRandomVals = complex(rand(5,4), rand(5,4));
theta_dbl_ref = angle(dblRandomVals);
theta_dbl_cdc = cordicangle(dblRandomVals)
fxpRandomVals = fi(dblRandomVals);
theta_fxp_cdc = cordicangle(fxpRandomVals)
```

theta_dbl_cdc =

1.0422	1.0987	1.2536	0.6122
0.5893	0.8874	0.3580	0.2020
0.5840	0.2113	0.8933	0.6355
0.7212	0.2074	0.9820	0.8110
1.3640	0.3288	1.4434	1.1291

theta_fxp_cdc =

1.0422	1.0989	1.2534	0.6123
0.5894	0.8872	0.3579	0.2019
0.5840	0.2112	0.8931	0.6357
0.7212	0.2075	0.9819	0.8110
1.3640	0.3289	1.4434	1.1289

DataTypeMode: Fixed-point: binary point scaling
 Signedness: Signed
 WordLength: 16
 FractionLength: 13

More About

CORDIC

CORDIC is an acronym for COordinate Rotation DIGital Computer. The Givens rotation-based CORDIC algorithm is one of the most hardware-efficient algorithms available because it requires only iterative shift-add operations (see References). The CORDIC algorithm eliminates the need for explicit multipliers. Using CORDIC, you can calculate various functions such as sine, cosine, arc sine, arc cosine, arc tangent, and vector magnitude. You can also use this algorithm for divide, square root, hyperbolic, and logarithmic functions.

Increasing the number of CORDIC iterations can produce more accurate results, but doing so increases the expense of the computation and adds latency.

More About

[1] Volder, JE. "The CORDIC Trigonometric Computing Technique." *IRE Transactions on Electronic Computers*. Vol. EC-8, September 1959, pp. 330-334.

[2] Andraka, R. "A survey of CORDIC algorithm for FPGA based computers." *Proceedings of the 1998 ACM/SIGDA sixth international symposium on Field programmable gate arrays*. Feb. 22-24, 1998, pp. 191-200.

[3] Walther, J.S. "A Unified Algorithm for Elementary Functions." Hewlett-Packard Company, Palo Alto. Spring Joint Computer Conference, 1971, pp. 379-386. (from the collection of the Computer History Museum). www.computer.org/csdl/proceedings/afips/1971/5077/00/50770379.pdf

[4] Schelin, Charles W. "Calculator Function Approximation." *The American Mathematical Monthly*. Vol. 90, No. 5, May 1983, pp. 317-325.

Algorithms

Signal Flow Diagrams

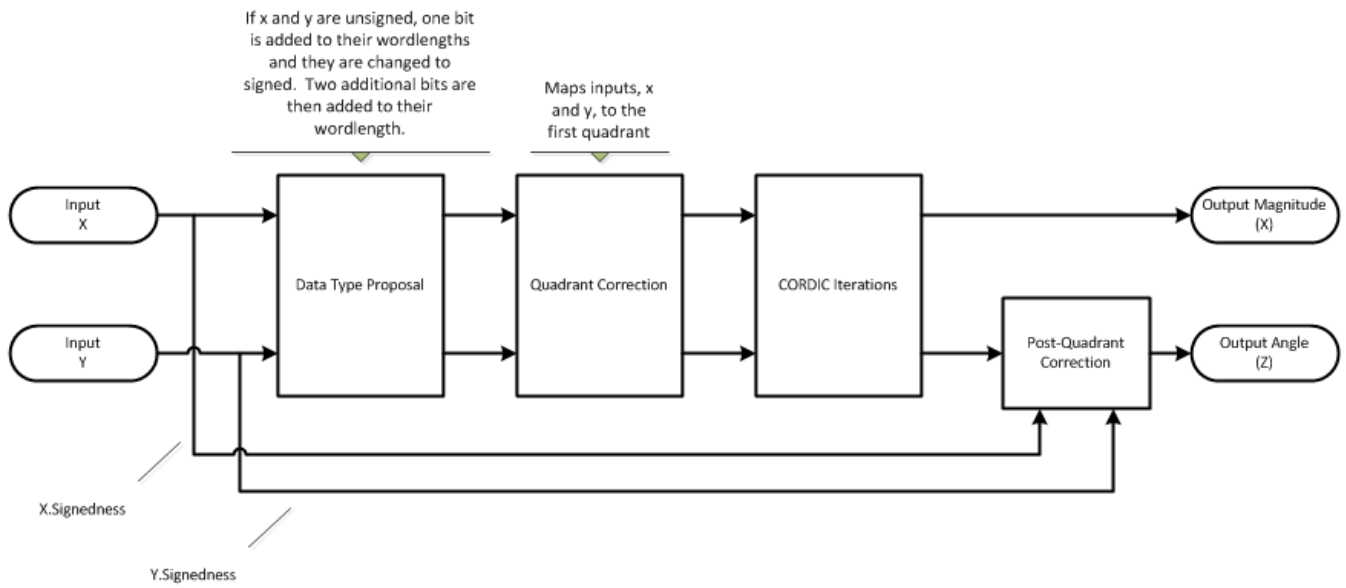

CORDIC Vectorsing Kernel

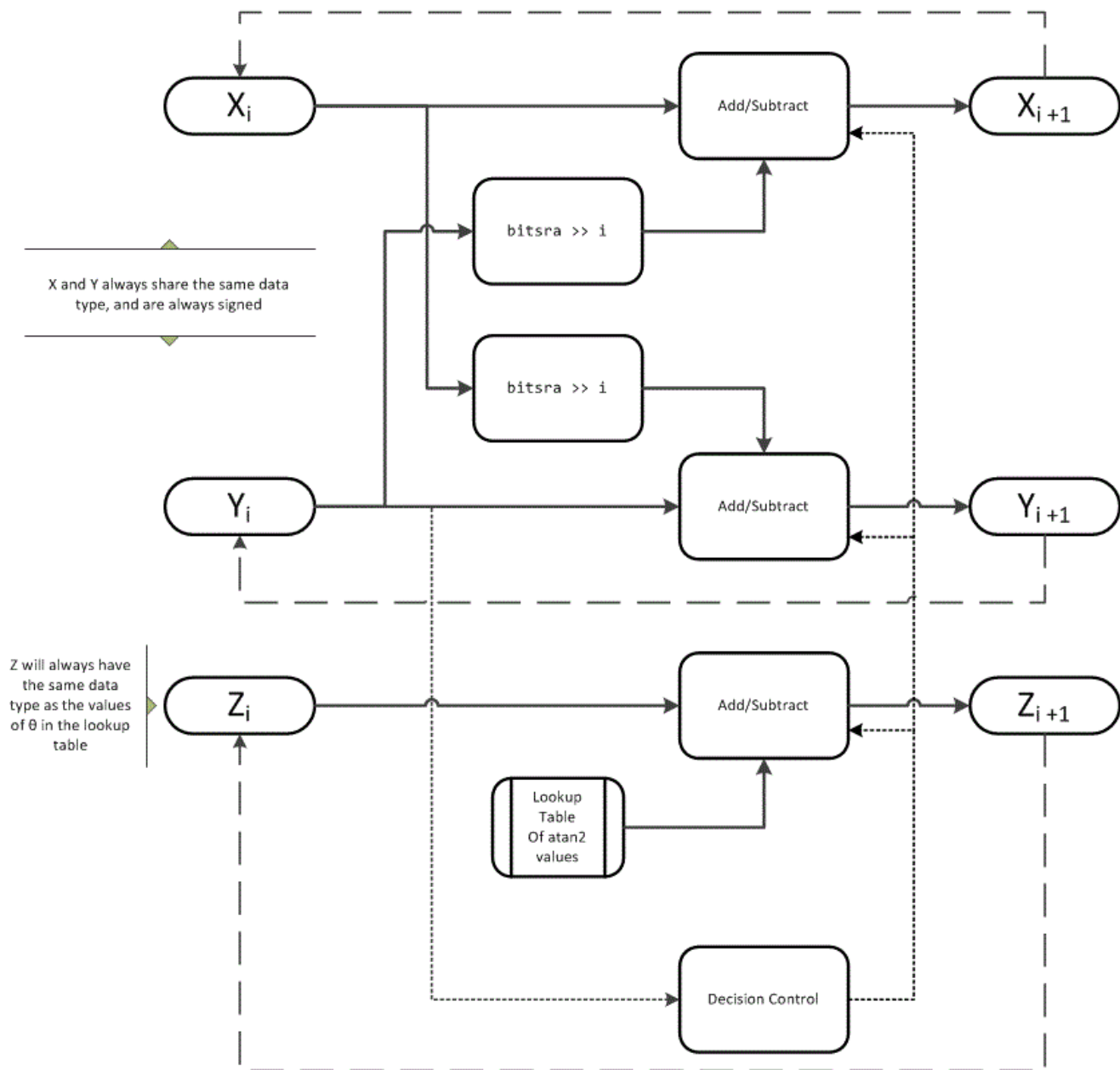

The accuracy of the CORDIC kernel depends on the choice of initial values for X , Y , and Z . This algorithm uses the following initial values:

- x_0 is initialized to the x input value
- y_0 is initialized to the y input value
- z_0 is initialized to 0

fimath Propagation Rules

CORDIC functions discard any local `fimath` attached to the input.

The CORDIC functions use their own internal `fimath` when performing calculations:

- `OverflowAction`—`Wrap`
- `RoundingMethod`—`Floor`

The output has no attached `fimath`.

Extended Capabilities**C/C++ Code Generation**

Generate C and C++ code using MATLAB® Coder™.

Usage notes and limitations:

- Variable-size signals are not supported.
- The number of iterations the CORDIC algorithm performs, `niters`, must be a constant.

See Also

`angle` | `cordicabs` | `cordicatan2` | `cordiccart2pol`

Introduced in R2011b

cordicasin

CORDIC-based approximation of inverse sine

Syntax

```
theta = cordicasin(x)
theta = cordicasin(x, niters)
```

Description

`theta = cordicasin(x)` returns the inverse sine of `x` based on a CORDIC approximation.

`theta = cordicasin(x, niters)` returns the inverse sine of `x` performing `niters` iterations of the CORDIC algorithm.

Examples

Calculate CORDIC Inverse Sine

Compute the inverse Sine of a fixed-point `fi` object using a CORDIC implementation.

```
a = fi(-1:.1:1,1,16);
b = cordicasin(a);
plot(a, b);
title('Inverse CORDIC Sine');
```

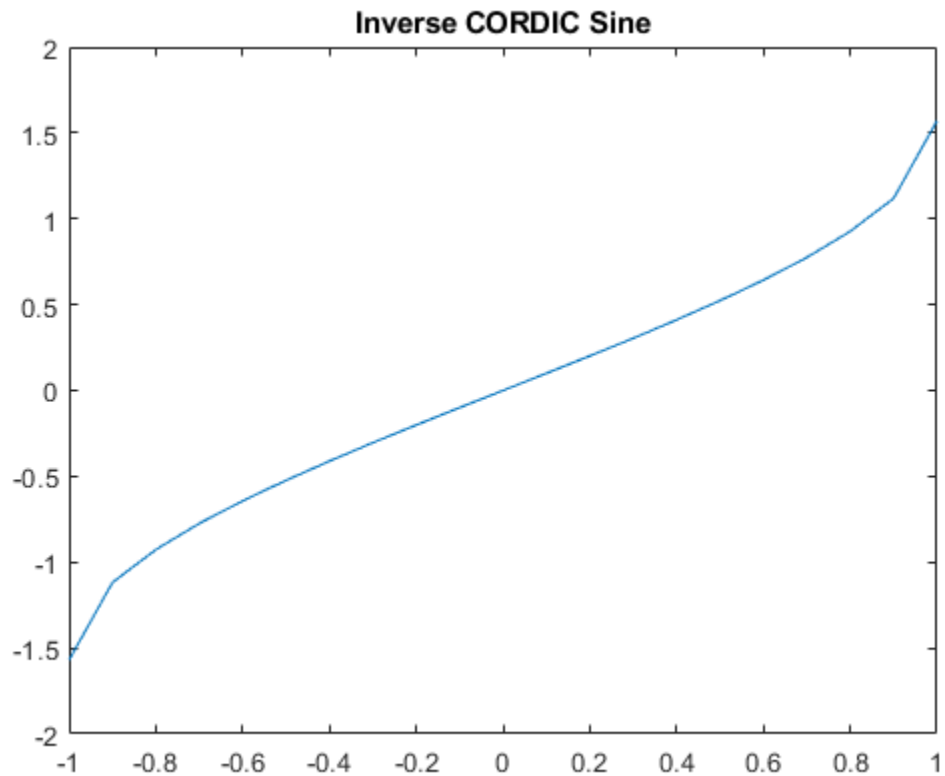

Calculate CORDIC Inverse Sine with Specified Number of Iterations

Find the inverse sine of a `fi` object using a CORDIC implementation and specify the number of iterations the CORDIC kernel should perform. Plot the CORDIC approximation of the inverse sine with varying numbers of iterations.

```
a = fi(-1:.1:1, 1, 16);
for i = 5:5:20
    b = cordicasin(a,i);
    plot(a,b);
    hold on;
end
legend('5 iterations', '10 iterations', '15 iterations', '20 iterations')
```

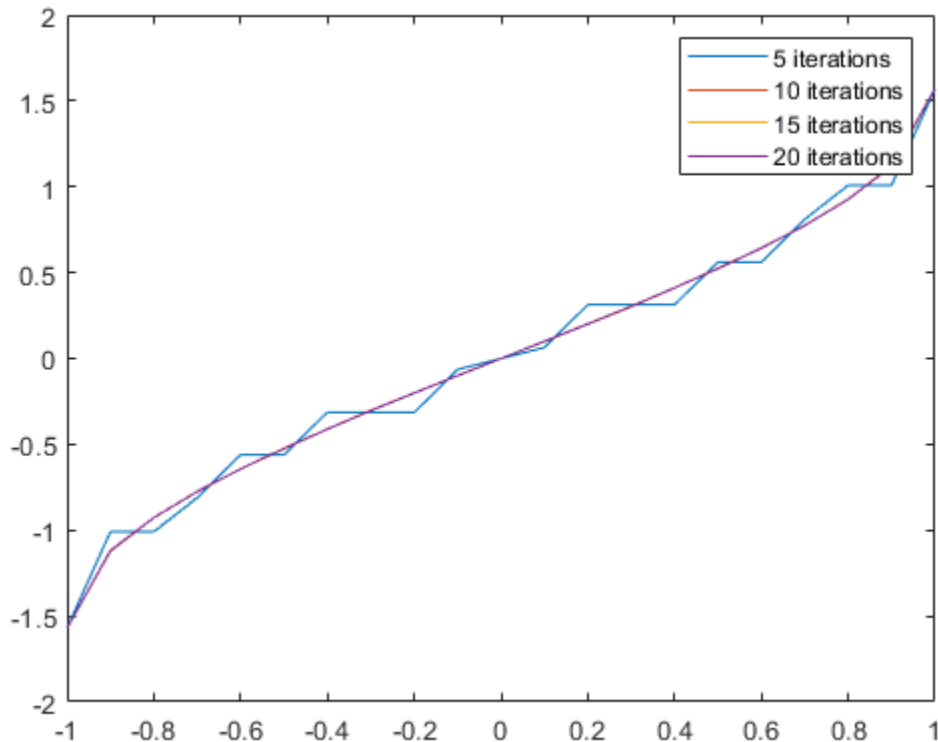
Input Arguments

x — Numeric input

scalar | vector | matrix | multidimensional array

Numeric input, specified as a scalar, vector, matrix, or multidimensional array.

Data Types: single | double | int8 | int16 | int32 | int64 | uint8 | uint16 | uint32 | uint64 | fi

Complex Number Support: Yes

niters — Number of iterations

scalar

The number of iterations that the CORDIC algorithm performs, specified as a positive, integer-valued scalar. If you do not specify `niters`, the algorithm uses a default value. For fixed-point inputs, the default value of `niters` is one less than the word length of the input array, `theta`. For double-precision inputs, the default value of `niters` is 52. For single-precision inputs, the default value is 23.

Data Types: single | double | int8 | int16 | int32 | int64 | uint8 | uint16 | uint32 | uint64 | fi

Output Arguments

theta — Inverse sine angle values

scalar | vector | matrix | n-dimensional array

Inverse sine angle values in rad.

See Also

Functions

cordiccos | cordicsin

Introduced in R2018b

cordicatan2

CORDIC-based four quadrant inverse tangent

Syntax

```
theta = cordicatan2(y,x)
theta = cordicatan2(y,x,niters)
```

Description

`theta = cordicatan2(y,x)` computes the four quadrant arctangent of `y` and `x` using a “CORDIC” on page 4-250 algorithm approximation.

`theta = cordicatan2(y,x,niters)` performs `niters` iterations of the algorithm.

Input Arguments

`y,x`

`y,x` are Cartesian coordinates. `y` and `x` must be the same size. If they are not the same size, at least one value must be a scalar value. Both `y` and `x` must have the same data type.

`niters`

`niters` is the number of iterations the CORDIC algorithm performs. This is an optional argument. When specified, `niters` must be a positive, integer-valued scalar. If you do not specify `niters` or if you specify a value that is too large, the algorithm uses a maximum value. For fixed-point operation, the maximum number of iterations is one less than the word length of `y` or `x`. For floating-point operation, the maximum value is 52 for double or 23 for single. Increasing the number of iterations can produce more accurate results but also increases the expense of the computation and adds latency.

Output Arguments

`theta`

`theta` is the arctangent value, which is in the range $[-\pi, \pi]$ radians. If `y` and `x` are floating-point numbers, then `theta` has the same data type as `y` and `x`. Otherwise, `theta` is a fixed-point data type with the same word length as `y` and `x` and with a best-precision fraction length for the $[-\pi, \pi]$ range.

Examples

Floating-point CORDIC arctangent calculation.

```
theta_cdat2_float = cordicatan2(0.5,-0.5)
```

```
theta_cdat2_float =  
    2.3562
```

Fixed- point CORDIC arctangent calculation.

```
theta_cdat2_fixpt = cordicatan2(fi(0.5,1,16,15),fi(-0.5,1,16,15));
```

```
theta_cdat2_fixpt =  
    2.3562
```

```
    DataTypeMode: Fixed-point: binary point scaling  
    Signedness: Signed  
    WordLength: 16  
    FractionLength: 13
```

More About

CORDIC

CORDIC is an acronym for COordinate Rotation DIgital Computer. The Givens rotation-based CORDIC algorithm is one of the most hardware-efficient algorithms available because it requires only iterative shift-add operations (see References). The CORDIC algorithm eliminates the need for explicit multipliers. Using CORDIC, you can calculate various functions such as sine, cosine, arc sine, arc cosine, arc tangent, and vector magnitude. You can also use this algorithm for divide, square root, hyperbolic, and logarithmic functions.

Increasing the number of CORDIC iterations can produce more accurate results, but doing so increases the expense of the computation and adds latency.

More About

[1] Volder, JE. "The CORDIC Trigonometric Computing Technique." *IRE Transactions on Electronic Computers*. Vol. EC-8, September 1959, pp. 330-334.

[2] Andraka, R. "A survey of CORDIC algorithm for FPGA based computers." *Proceedings of the 1998 ACM/SIGDA sixth international symposium on Field programmable gate arrays*. Feb. 22-24, 1998, pp. 191-200.

[3] Walther, J.S. "A Unified Algorithm for Elementary Functions." Hewlett-Packard Company, Palo Alto. Spring Joint Computer Conference, 1971, pp. 379-386. (from the collection of the Computer History Museum). www.computer.org/csdl/proceedings/afips/1971/5077/00/50770379.pdf

[4] Schelin, Charles W. "Calculator Function Approximation." *The American Mathematical Monthly*. Vol. 90, No. 5, May 1983, pp. 317-325.

Algorithms

Signal Flow Diagrams

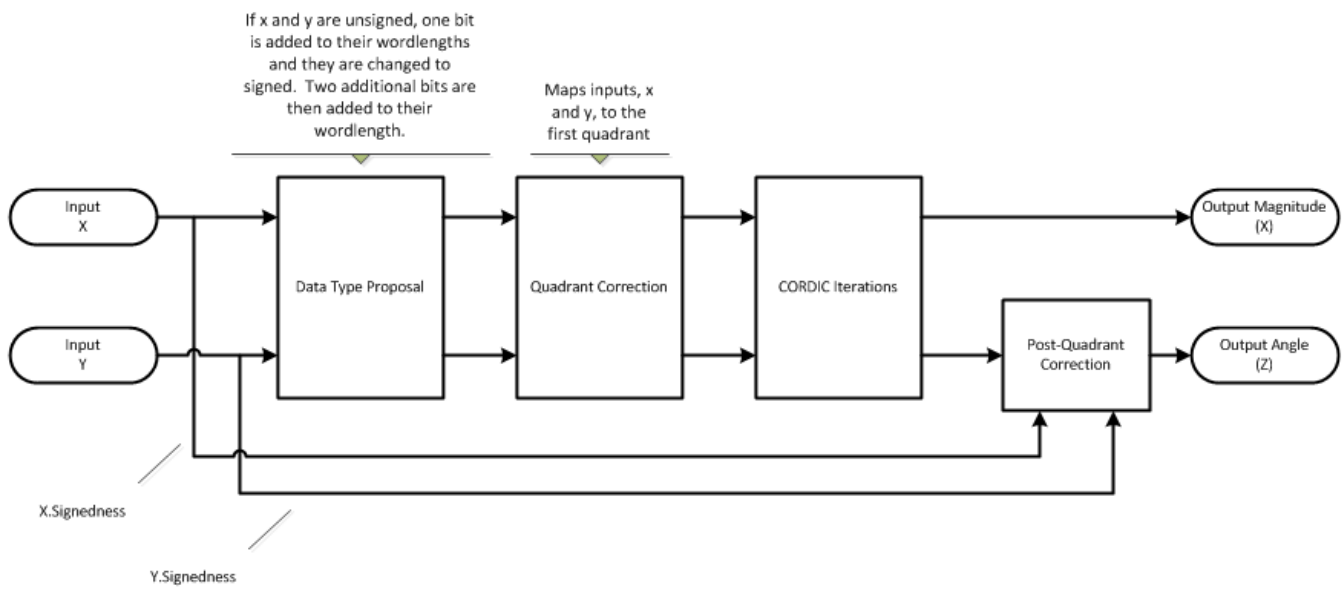

CORDIC Vectorsing Kernel

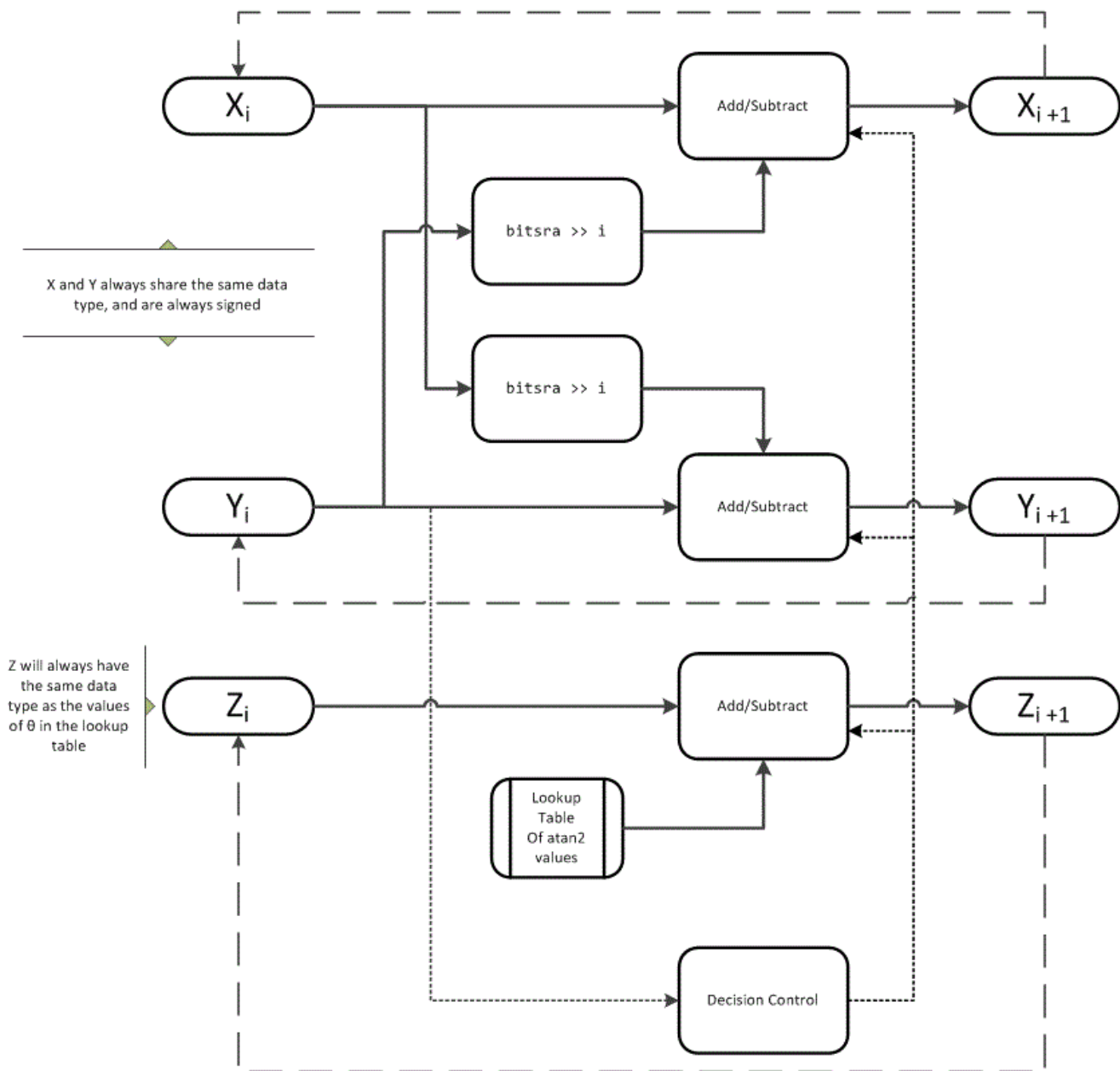

The accuracy of the CORDIC kernel depends on the choice of initial values for X , Y , and Z . This algorithm uses the following initial values:

- x_0 is initialized to the x input value
- y_0 is initialized to the y input value
- z_0 is initialized to 0

fimath Propagation Rules

CORDIC functions discard any local `fimath` attached to the input.

The CORDIC functions use their own internal `fimath` when performing calculations:

- `OverflowAction`—`Wrap`
- `RoundingMethod`—`Floor`

The output has no attached `fimath`.

Extended Capabilities

C/C++ Code Generation

Generate C and C++ code using MATLAB® Coder™.

Usage notes and limitations:

- Variable-size signals are not supported.
- The number of iterations the CORDIC algorithm performs, `nIters`, must be a constant.

See Also

`atan2` | `atan2` | `cordiccos` | `cordicsin`

Topics

“Calculate Fixed-Point Arctangent”

Introduced in R2011b

cordiccart2pol

CORDIC-based approximation of Cartesian-to-polar conversion

Syntax

```
[theta,r] = cordiccart2pol(x,y)
[theta,r] = cordiccart2pol(x,y, niters)
[theta,r] = cordiccart2pol(x,y, niters, 'ScaleOutput',b)
[theta,r] = cordiccart2pol(x,y, 'ScaleOutput',b)
```

Description

`[theta,r] = cordiccart2pol(x,y)` using a CORDIC algorithm approximation, returns the polar coordinates, angle `theta` and radius `r`, of the Cartesian coordinates, `x` and `y`.

`[theta,r] = cordiccart2pol(x,y, niters)` performs `niters` iterations of the algorithm.

`[theta,r] = cordiccart2pol(x,y, niters, 'ScaleOutput',b)` specifies both the number of iterations and, depending on the Boolean value of `b`, whether to scale the `r` output by the inverse CORDIC gain value.

`[theta,r] = cordiccart2pol(x,y, 'ScaleOutput',b)` scales the `r` output by the inverse CORDIC gain value, depending on the Boolean value of `b`.

Input Arguments

`x,y`

`x,y` are Cartesian coordinates. `x` and `y` must be the same size. If they are not the same size, at least one value must be a scalar value. Both `x` and `y` must have the same data type.

`niters`

`niters` is the number of iterations the CORDIC algorithm performs. This argument is optional. When specified, `niters` must be a positive, integer-valued scalar. If you do not specify `niters`, or if you specify a value that is too large, the algorithm uses a maximum value. For fixed-point operation, the maximum number of iterations is the word length of `r` or one less than the word length of `theta`, whichever is smaller. For floating-point operation, the maximum value is 52 for double or 23 for single. Increasing the number of iterations can produce more accurate results but also increases the expense of the computation and adds latency.

Name-Value Pair Arguments

Optional comma-separated pairs of `Name, Value` arguments, where `Name` is the argument name and `Value` is the corresponding value. `Name` must appear inside single quotes (' ').

`ScaleOutput`

`ScaleOutput` is a Boolean value that specifies whether to scale the output by the inverse CORDIC gain factor. This argument is optional. If you set `ScaleOutput` to `true` or `1`, the output values are

multiplied by a constant, which incurs extra computations. If you set `ScaleOutput` to `false` or `0`, the output is not scaled.

Default: `true`

Output Arguments

`theta`

`theta` contains the polar coordinates angle values, which are in the range $[-\pi, \pi]$ radians. If `x` and `y` are floating-point, then `theta` has the same data type as `x` and `y`. Otherwise, `theta` is a fixed-point data type with the same word length as `x` and `y` and with a best-precision fraction length for the $[-\pi, \pi]$ range.

`r`

`r` contains the polar coordinates radius magnitude values. `r` is real-valued and can be a scalar value or have the same dimensions as `theta`. If the inputs `x`, `y` are fixed-point values, `r` is also fixed point (and is always signed, with binary point scaling). Both `x`, `y` input values must have the same data type. If the inputs are signed, then the word length of `r` is the input word length + 2. If the inputs are unsigned, then the word length of `r` is the input word length + 3. The fraction length of `r` is always the same as the fraction length of the `x`, `y` inputs.

Examples

Convert fixed-point Cartesian coordinates to polar coordinates.

```
[thPos,r]=cordiccart2pol(sfi([0.75:-0.25:-1.0],16,15),sfi(0.5,16,15))
```

thPos =

```
0.5881 0.7854 1.1072 1.5708 2.0344 2.3562 2.5535 2.6780
```

```
    DataTypeMode: Fixed-point: binary point scaling
           Signedness: Signed
           WordLength: 16
           FractionLength: 13
```

r =

```
0.9014 0.7071 0.5591 0.5000 0.5591 0.7071 0.9014 1.1180
```

```
    DataTypeMode: Fixed-point: binary point scaling
           Signedness: Signed
           WordLength: 18
           FractionLength: 15
```

```
[thNeg,r]=...
```

```
cordiccart2pol(sfi([0.75:-0.25:-1.0],16,15),sfi(-0.5,16,15))
```

thNeg =

```
-0.5881 -0.7854 -1.1072 -1.5708 -2.0344 -2.3562 -2.5535 -2.6780
```

```
    DataTypeMode: Fixed-point: binary point scaling
```

Signedness: Signed
WordLength: 16
FractionLength: 13

r =

0.9014 0.7071 0.5591 0.5000 0.5591 0.7071 0.9014 1.1180

DataTypeMode: Fixed-point: binary point scaling
Signedness: Signed
WordLength: 18
FractionLength: 15

More About

CORDIC

CORDIC is an acronym for COordinate Rotation DIgital Computer. The Givens rotation-based CORDIC algorithm is one of the most hardware-efficient algorithms available because it requires only iterative shift-add operations (see References). The CORDIC algorithm eliminates the need for explicit multipliers. Using CORDIC, you can calculate various functions such as sine, cosine, arc sine, arc cosine, arc tangent, and vector magnitude. You can also use this algorithm for divide, square root, hyperbolic, and logarithmic functions.

Increasing the number of CORDIC iterations can produce more accurate results, but doing so increases the expense of the computation and adds latency.

More About

[1] Volder, JE. "The CORDIC Trigonometric Computing Technique." *IRE Transactions on Electronic Computers*. Vol. EC-8, September 1959, pp. 330-334.

[2] Andraka, R. "A survey of CORDIC algorithm for FPGA based computers." *Proceedings of the 1998 ACM/SIGDA sixth international symposium on Field programmable gate arrays*. Feb. 22-24, 1998, pp. 191-200.

[3] Walther, J.S. "A Unified Algorithm for Elementary Functions." Hewlett-Packard Company, Palo Alto. Spring Joint Computer Conference, 1971, pp. 379-386. (from the collection of the Computer History Museum). www.computer.org/csdl/proceedings/afips/1971/5077/00/50770379.pdf

[4] Schelin, Charles W. "Calculator Function Approximation." *The American Mathematical Monthly*. Vol. 90, No. 5, May 1983, pp. 317-325.

Algorithms

Signal Flow Diagrams

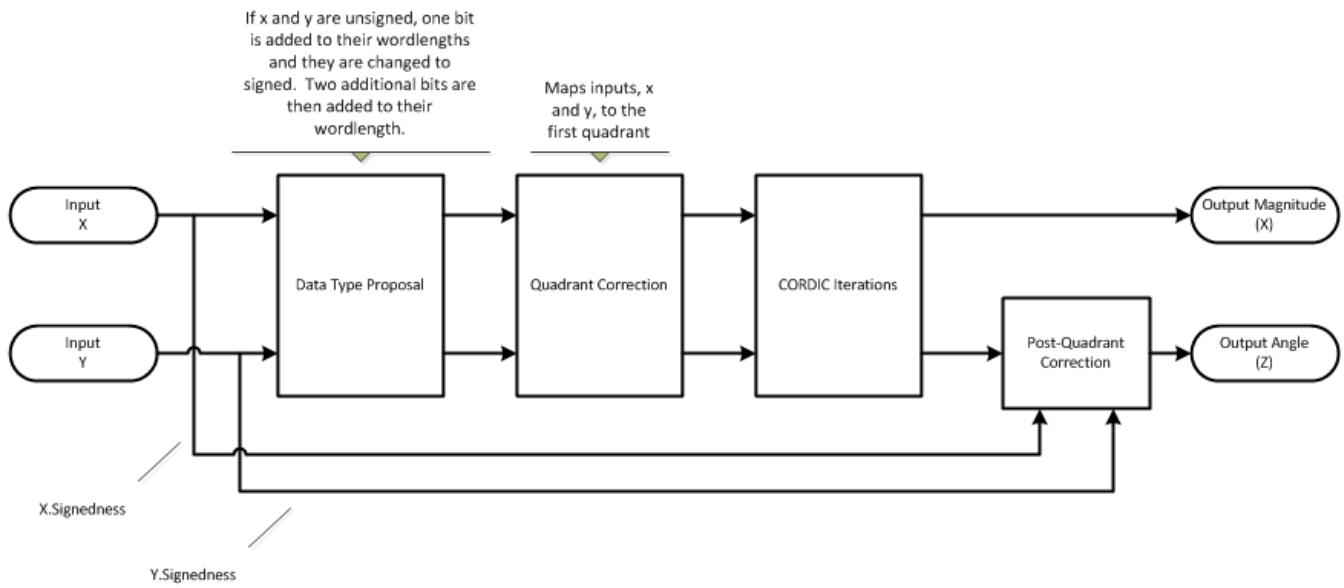

CORDIC Vectorsing Kernel

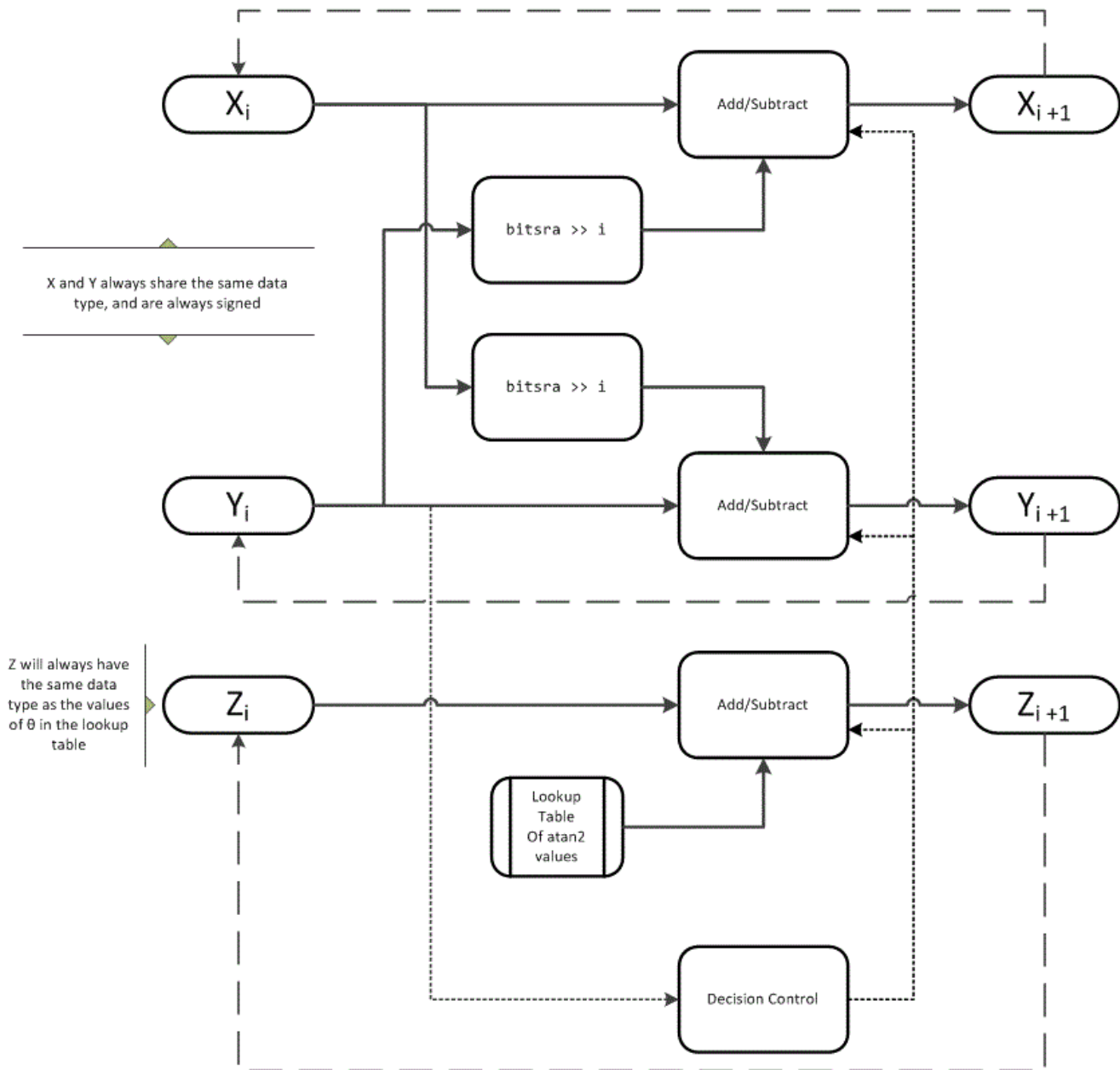

The accuracy of the CORDIC kernel depends on the choice of initial values for X , Y , and Z . This algorithm uses the following initial values:

- x_0 is initialized to the x input value
- y_0 is initialized to the y input value
- z_0 is initialized to 0

fimath Propagation Rules

CORDIC functions discard any local `fimath` attached to the input.

The CORDIC functions use their own internal `fimath` when performing calculations:

- `OverflowAction`—`Wrap`
- `RoundingMethod`—`Floor`

The output has no attached `fimath`.

Extended Capabilities

C/C++ Code Generation

Generate C and C++ code using MATLAB® Coder™.

Usage notes and limitations:

- Variable-size signals are not supported.
- The number of iterations the CORDIC algorithm performs, `nIters`, must be a constant.

See Also

`cart2pol` | `cordicatan2` | `cordicpol2cart`

Introduced in R2011b

cordicexp

CORDIC-based approximation of complex exponential

Syntax

```
y = cordicexp(theta, niters)
```

Description

`y = cordicexp(theta, niters)` computes $\cos(\theta) + j\sin(\theta)$ using a “CORDIC” on page 4-261 algorithm approximation. `y` contains the approximated complex result.

Input Arguments

theta

`theta` can be a signed or unsigned scalar, vector, matrix, or N-dimensional array containing the angle values in radians. All values of `theta` must be real and in the range $[-2\pi, 2\pi)$.

niters

`niters` is the number of iterations the CORDIC algorithm performs. This is an optional argument. When specified, `niters` must be a positive, integer-valued scalar. If you do not specify `niters` or if you specify a value that is too large, the algorithm uses a maximum value. For fixed-point operation, the maximum number of iterations is one less than the word length of `theta`. For floating-point operation, the maximum value is 52 for double or 23 for single. Increasing the number of iterations can produce more accurate results, but it also increases the expense of the computation and adds latency.

Output Arguments

y

`y` is the approximated complex result of the `cordicexp` function. When the input to the function is floating point, the output data type is the same as the input data type. When the input is fixed point, the output has the same word length as the input, and a fraction length equal to the `WordLength - 2`.

Examples

The following example illustrates the effect of the number of iterations on the result of the `cordicexp` approximation.

```

wrdbl = 8;
theta = fi(pi/2, 1, wrdbl);
fprintf('\n\nNITERS\t\tY (SIN)\t\tERROR\t\tLSBs\t\tX (COS)\t\tERROR\t\tLSBs\n');
fprintf('-----\t\t-----\t\t-----\t\t-----\t\t-----\t\t-----\t\t-----\n');
for niters = 1:(wrdbl - 1)
    cis = cordicexp(theta, niters);
    fl = cis.FractionLength;
    x = real(cis);
    y = imag(cis);
    x_dbl = double(x);
    x_err = abs(x_dbl - cos(double(theta)));
    y_dbl = double(y);
    y_err = abs(y_dbl - sin(double(theta)));
    fprintf('%d\t\t%.4f\t\t%.4f\t\t%.1f\t\t%.4f\t\t%.4f\t\t%.1f\n',...
        niters,y_dbl,y_err,(y_err*pow2(fl)),x_dbl,x_err,(x_err*pow2(fl)));
end
fprintf('\n');

```

The output table appears as follows:

NITERS	Y (SIN)	ERROR	LSBs	X (COS)	ERROR	LSBs
-----	-----	-----	-----	-----	-----	-----
1	0.7031	0.2968	19.0	0.7031	0.7105	45.5
2	0.9375	0.0625	4.0	0.3125	0.3198	20.5
3	0.9844	0.0156	1.0	0.0938	0.1011	6.5
4	0.9844	0.0156	1.0	-0.0156	0.0083	0.5
5	1.0000	0.0000	0.0	0.0312	0.0386	2.5
6	1.0000	0.0000	0.0	0.0000	0.0073	0.5
7	1.0000	0.0000	0.0	0.0156	0.0230	1.5

More About

CORDIC

CORDIC is an acronym for COordinate Rotation DIGital Computer. The Givens rotation-based CORDIC algorithm is one of the most hardware-efficient algorithms available because it requires only iterative shift-add operations (see References). The CORDIC algorithm eliminates the need for explicit multipliers. Using CORDIC, you can calculate various functions such as sine, cosine, arc sine, arc cosine, arc tangent, and vector magnitude. You can also use this algorithm for divide, square root, hyperbolic, and logarithmic functions.

Increasing the number of CORDIC iterations can produce more accurate results, but doing so increases the expense of the computation and adds latency.

More About

[1] Volder, JE. "The CORDIC Trigonometric Computing Technique." *IRE Transactions on Electronic Computers*. Vol. EC-8, September 1959, pp. 330-334.

[2] Andraka, R. "A survey of CORDIC algorithm for FPGA based computers." *Proceedings of the 1998 ACM/SIGDA sixth international symposium on Field programmable gate arrays*. Feb. 22-24, 1998, pp. 191-200.

[3] Walther, J.S. "A Unified Algorithm for Elementary Functions." Hewlett-Packard Company, Palo Alto. Spring Joint Computer Conference, 1971, pp. 379-386. (from the collection of the Computer History Museum). www.computer.org/csdl/proceedings/afips/1971/5077/00/50770379.pdf

[4] Schelin, Charles W. "Calculator Function Approximation." *The American Mathematical Monthly*. Vol. 90, No. 5, May 1983, pp. 317-325.

Algorithms

Signal Flow Diagrams

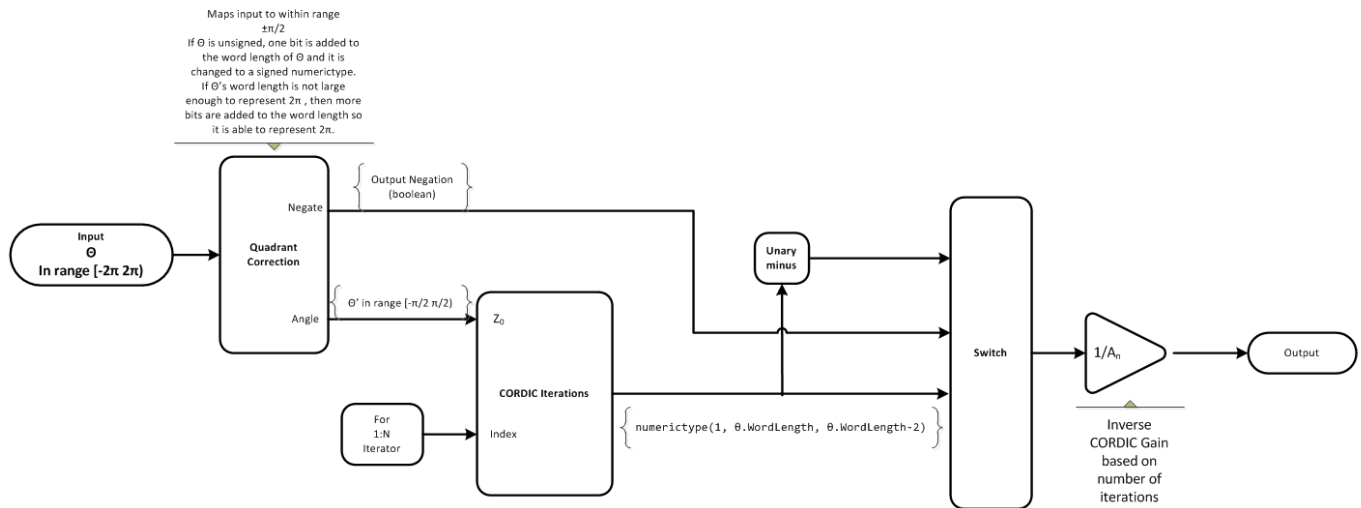

CORDIC Rotation Kernel

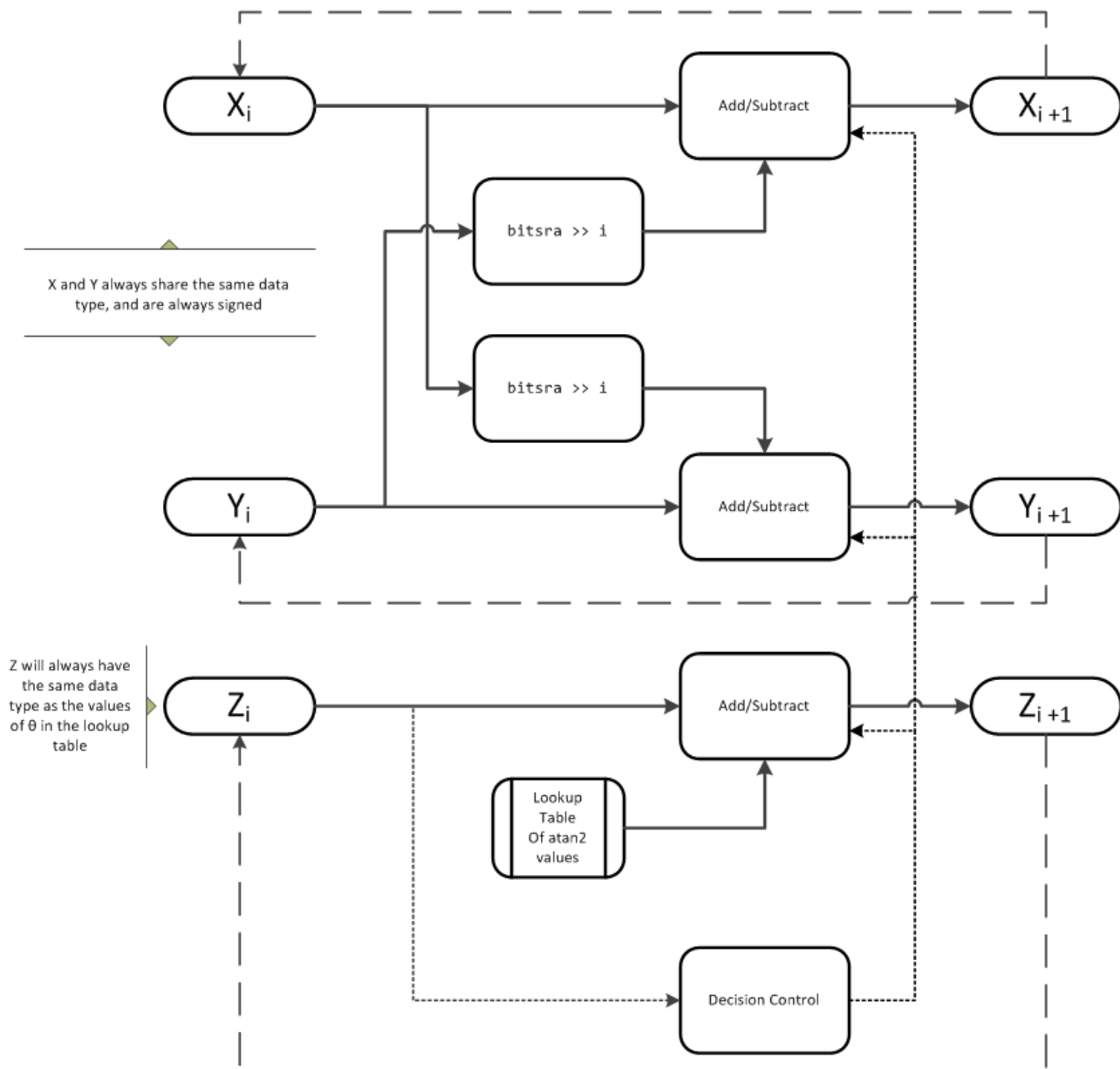

X represents the real part, Y represents the imaginary part, and Z represents theta. The accuracy of the CORDIC rotation kernel depends on the choice of initial values for X , Y , and Z . This algorithm uses the following initial values:

z_0 is initialized to the θ input argument value

x_0 is initialized to $\frac{1}{A_N}$

y_0 is initialized to 0

fimath Propagation Rules

CORDIC functions discard any local `fimath` attached to the input.

The CORDIC functions use their own internal `fimath` when performing calculations:

- `OverflowAction`—`Wrap`
- `RoundingMethod`—`Floor`

The output has no attached `fimath`.

Extended Capabilities**C/C++ Code Generation**

Generate C and C++ code using MATLAB® Coder™.

Usage notes and limitations:

- Variable-size signals are not supported.
- The number of iterations the CORDIC algorithm performs, `nIters`, must be a constant.

See Also

`cordiccos` | `cordicsin` | `cordicsincos`

Topics

“Calculate Fixed-Point Sine and Cosine”

“Calculate Fixed-Point Arctangent”

Introduced in R2010a

cordiccos

CORDIC-based approximation of cosine

Syntax

```
y = cordiccos(theta, niters)
```

Description

y = cordiccos(*theta*, *niters*) computes the cosine of *theta* using a “CORDIC” on page 4-267 algorithm approximation.

Input Arguments

theta

theta can be a signed or unsigned scalar, vector, matrix, or N-dimensional array containing the angle values in radians. All values of *theta* must be real and in the range $[-2\pi, 2\pi)$.

niters

niters is the number of iterations the CORDIC algorithm performs. This is an optional argument. When specified, *niters* must be a positive, integer-valued scalar. If you do not specify *niters* or if you specify a value that is too large, the algorithm uses a maximum value. For fixed-point operation, the maximum number of iterations is one less than the word length of *theta*. For floating-point operation, the maximum value is 52 for double or 23 for single. Increasing the number of iterations can produce more accurate results, but it also increases the expense of the computation and adds latency.

Output Arguments

y

y is the CORDIC-based approximation of the cosine of *theta*. When the input to the function is floating point, the output data type is the same as the input data type. When the input is fixed point, the output has the same word length as the input, and a fraction length equal to the `WordLength - 2`.

Examples

Compare Results of cordiccos and cos Functions

Compare the results produced by various iterations of the `cordiccos` algorithm to the results of the double-precision `cos` function.

```
% Create 1024 points between [0,2*pi)
stepSize = pi/512;
thRadDb1 = 0:stepSize:(2*pi - stepSize);
thRadFxp = sfi(thRadDb1,12);    % signed, 12-bit fixed-point
```

```

cosThRef = cos(double(thRadFxp)); % reference results

% Use 12-bit quantized inputs and vary the number
% of iterations from 2 to 10.
% Compare the fixed-point CORDIC results to the
% double-precision trig function results.
for niters = 2:2:10
    cdcCosTh = cordiccos(thRadFxp,niters);
    errCdcRef = cosThRef - double(cdcCosTh);
end

figure
hold on
axis([0 2*pi -1.25 1.25]);
plot(thRadFxp,cosThRef,'b');
plot(thRadFxp,cdcCosTh,'g');
plot(thRadFxp,errCdcRef,'r');
ylabel('cos(\Theta)');
gca.XTick = 0:pi/2:2*pi;
gca.XTickLabel = {'0','pi/2','pi','3*pi/2','2*pi'};
gca.YTick = -1:0.5:1;
gca.YTickLabel = {'-1.0','-0.5','0','0.5','1.0'};
ref_str = 'Reference: cos(double(\Theta))';
cdc_str = sprintf('12-bit CORDIC cosine; N = %d',niters);
err_str = sprintf('Error (max = %f)', max(abs(errCdcRef)));
legend(ref_str,cdc_str,err_str);

```

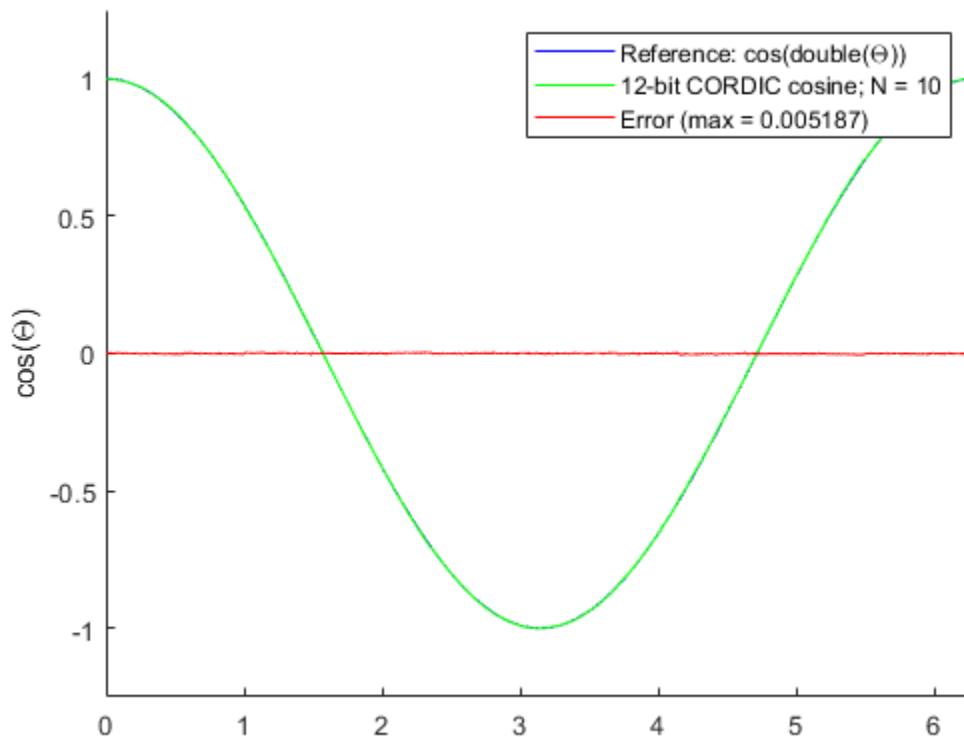

After 10 iterations, the CORDIC algorithm has approximated the cosine of θ to within 0.005187 of the double-precision cosine result.

More About

CORDIC

CORDIC is an acronym for COordinate Rotation DIgital Computer. The Givens rotation-based CORDIC algorithm is one of the most hardware-efficient algorithms available because it requires only iterative shift-add operations (see References). The CORDIC algorithm eliminates the need for explicit multipliers. Using CORDIC, you can calculate various functions such as sine, cosine, arc sine, arc cosine, arc tangent, and vector magnitude. You can also use this algorithm for divide, square root, hyperbolic, and logarithmic functions.

Increasing the number of CORDIC iterations can produce more accurate results, but doing so increases the expense of the computation and adds latency.

More About

[1] Volder, JE. "The CORDIC Trigonometric Computing Technique." *IRE Transactions on Electronic Computers*. Vol. EC-8, September 1959, pp. 330-334.

[2] Andraka, R. "A survey of CORDIC algorithm for FPGA based computers." *Proceedings of the 1998 ACM/SIGDA sixth international symposium on Field programmable gate arrays*. Feb. 22-24, 1998, pp. 191-200.

[3] Walther, J.S. "A Unified Algorithm for Elementary Functions." Hewlett-Packard Company, Palo Alto. Spring Joint Computer Conference, 1971, pp. 379-386. (from the collection of the Computer History Museum). www.computer.org/csdl/proceedings/afips/1971/5077/00/50770379.pdf

[4] Schelin, Charles W. "Calculator Function Approximation." *The American Mathematical Monthly*. Vol. 90, No. 5, May 1983, pp. 317-325.

Algorithms

Signal Flow Diagrams

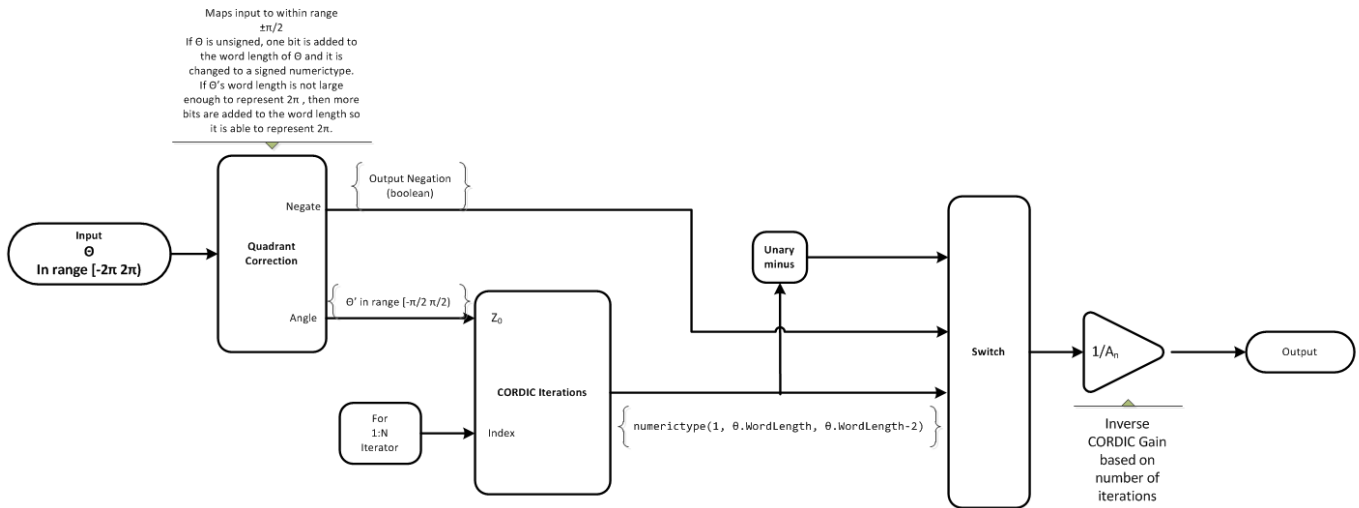

CORDIC Rotation Kernel

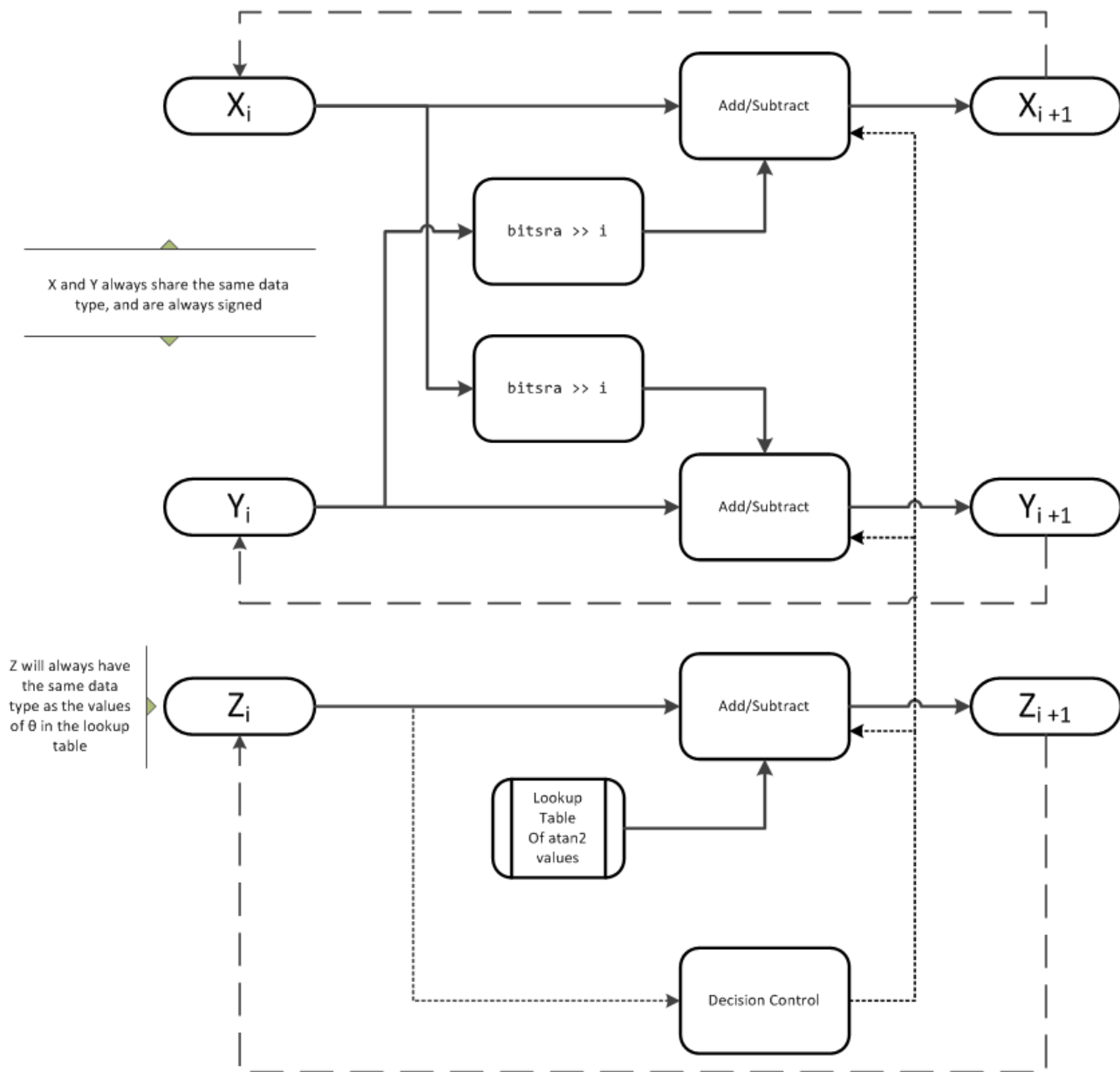

X represents the sine, Y represents the cosine, and Z represents theta. The accuracy of the CORDIC rotation kernel depends on the choice of initial values for X , Y , and Z . This algorithm uses the following initial values:

z_0 is initialized to the θ input argument value

x_0 is initialized to $\frac{1}{A_N}$

y_0 is initialized to 0

fimath Propagation Rules

CORDIC functions discard any local `fimath` attached to the input.

The CORDIC functions use their own internal `fimath` when performing calculations:

- `OverflowAction`—`Wrap`
- `RoundingMethod`—`Floor`

The output has no attached `fimath`.

Extended Capabilities**C/C++ Code Generation**

Generate C and C++ code using MATLAB® Coder™.

Usage notes and limitations:

- Variable-size signals are not supported.
- The number of iterations the CORDIC algorithm performs, `nIters`, must be a constant.

See Also

`cordiccxp` | `cordicsin` | `cordicsincos` | `cos` | `sin`

Topics

“Calculate Fixed-Point Sine and Cosine”

“Calculate Fixed-Point Arctangent”

Introduced in R2010a

cordicpol2cart

CORDIC-based approximation of polar-to-Cartesian conversion

Syntax

```
[x,y] = cordicpol2cart(theta,r)
[x,y] = cordicpol2cart(theta,r,niters)
[x,y] = cordicpol2cart(theta,r,Name,Value)
[x,y] = cordicpol2cart(theta,r,niters,Name,Value)
```

Description

`[x,y] = cordicpol2cart(theta,r)` returns the Cartesian xy coordinates of $r \cdot e^{j\theta}$ using a CORDIC algorithm approximation.

`[x,y] = cordicpol2cart(theta,r,niters)` performs `niters` iterations of the algorithm.

`[x,y] = cordicpol2cart(theta,r,Name,Value)` scales the output depending on the Boolean value of `b`.

`[x,y] = cordicpol2cart(theta,r,niters,Name,Value)` specifies both the number of iterations and `Name, Value` pair for whether to scale the output.

Input Arguments

theta

`theta` can be a signed or unsigned scalar, vector, matrix, or N -dimensional array containing the angle values in radians. All values of `theta` must be in the range $[-2\pi, 2\pi]$.

r

`r` contains the input magnitude values and can be a scalar or have the same dimensions as `theta`. `r` must be real valued.

niters

`niters` is the number of iterations the CORDIC algorithm performs. This argument is optional. When specified, `niters` must be a positive, integer-valued scalar. If you do not specify `niters`, or if you specify a value that is too large, the algorithm uses a maximum value. For fixed-point operation, the maximum number of iterations is the word length of `r` or one less than the word length of `theta`, whichever is smaller. For floating-point operation, the maximum value is 52 for double or 23 for single. Increasing the number of iterations can produce more accurate results but also increases the expense of the computation and adds latency.

Name-Value Pair Arguments

Optional comma-separated pairs of `Name, Value` arguments, where `Name` is the argument name and `Value` is the corresponding value. `Name` must appear inside single quotes (' ').

ScaleOutput

`ScaleOutput` is a Boolean value that specifies whether to scale the output by the inverse CORDIC gain factor. This argument is optional. If you set `ScaleOutput` to `true` or `1`, the output values are multiplied by a constant, which incurs extra computations. If you set `ScaleOutput` to `false` or `0`, the output is not scaled.

Default: `true`

Output Arguments

[*x*, *y*]

[*x*, *y*] contains the approximated Cartesian coordinates. When the input *r* is floating point, the output [*x*, *y*] has the same data type as the input.

When the input *r* is a *signed* integer or fixed point data type, the outputs [*x*, *y*] are signed `fi` objects. These `fi` objects have word lengths that are two bits larger than that of *r*. Their fraction lengths are the same as the fraction length of *r*.

When the input *r* is an *unsigned* integer or fixed point, the outputs [*x*, *y*] are signed `fi` objects. These `fi` objects have word lengths are three bits larger than that of *r*. Their fraction lengths are the same as the fraction length of *r*.

Examples

Run the following code, and evaluate the accuracy of the CORDIC-based Polar-to-Cartesian conversion.

```

wrdLn = 16;
theta = fi(pi/3, 1, wrdLn);
u      = fi( 2.0, 1, wrdLn);

fprintf('\n\nNITERS\tX\t\t ERROR\t LSBs\t\tY\t\t ERROR\t LSBs\n');
fprintf('-----\t-----\t -----\t ----\t\t-----\t -----\t ----\n');
for niters = 1:(wrdLn - 1)
    [x_ref, y_ref] = pol2cart(double(theta),double(u));
    [x_fi, y_fi] = cordicpol2cart(theta, u, niters);
    x_dbl = double(x_fi);
    y_dbl = double(y_fi);
    x_err = abs(x_dbl - x_ref);
    y_err = abs(y_dbl - y_ref);
    fprintf('%d\t%1.4f\t %1.4f\t %1.1f\t\t%1.4f\t %1.4f\t %1.1f\n',...
        niters,x_dbl,x_err,(x_err * pow2(x_fi.FractionLength)),...
        y_dbl,y_err,(y_err * pow2(y_fi.FractionLength)));
end
fprintf('\n');

```

NITERS	X	ERROR	LSBs	Y	ERROR	LSBs
1	1.4142	0.4142	3392.8	1.4142	0.3178	2603.8
2	0.6324	0.3676	3011.2	1.8973	0.1653	1354.2
3	1.0737	0.0737	603.8	1.6873	0.0448	366.8
4	0.8561	0.1440	1179.2	1.8074	0.0753	617.2
5	0.9672	0.0329	269.2	1.7505	0.0185	151.2
6	1.0214	0.0213	174.8	1.7195	0.0126	102.8
7	0.9944	0.0056	46.2	1.7351	0.0031	25.2
8	1.0079	0.0079	64.8	1.7274	0.0046	37.8
9	1.0011	0.0011	8.8	1.7313	0.0007	5.8
10	0.9978	0.0022	18.2	1.7333	0.0012	10.2
11	0.9994	0.0006	5.2	1.7323	0.0003	2.2
12	1.0002	0.0002	1.8	1.7318	0.0002	1.8
13	0.9999	0.0002	1.2	1.7321	0.0000	0.2
14	0.9996	0.0004	3.2	1.7321	0.0000	0.2
15	0.9998	0.0003	2.2	1.7321	0.0000	0.2

More About

CORDIC

CORDIC is an acronym for COordinate Rotation DIGital Computer. The Givens rotation-based CORDIC algorithm is one of the most hardware-efficient algorithms available because it requires only iterative shift-add operations (see References). The CORDIC algorithm eliminates the need for explicit multipliers. Using CORDIC, you can calculate various functions such as sine, cosine, arc sine, arc cosine, arc tangent, and vector magnitude. You can also use this algorithm for divide, square root, hyperbolic, and logarithmic functions.

Increasing the number of CORDIC iterations can produce more accurate results, but doing so increases the expense of the computation and adds latency.

More About

[1] Volder, JE. "The CORDIC Trigonometric Computing Technique." *IRE Transactions on Electronic Computers*. Vol. EC-8, September 1959, pp. 330-334.

[2] Andraka, R. "A survey of CORDIC algorithm for FPGA based computers." *Proceedings of the 1998 ACM/SIGDA sixth international symposium on Field programmable gate arrays*. Feb. 22-24, 1998, pp. 191-200.

[3] Walther, J.S. "A Unified Algorithm for Elementary Functions." Hewlett-Packard Company, Palo Alto. Spring Joint Computer Conference, 1971, pp. 379-386. (from the collection of the Computer History Museum). www.computer.org/csdl/proceedings/afips/1971/5077/00/50770379.pdf

[4] Schelin, Charles W. "Calculator Function Approximation." *The American Mathematical Monthly*. Vol. 90, No. 5, May 1983, pp. 317-325.

Algorithms

Signal Flow Diagrams

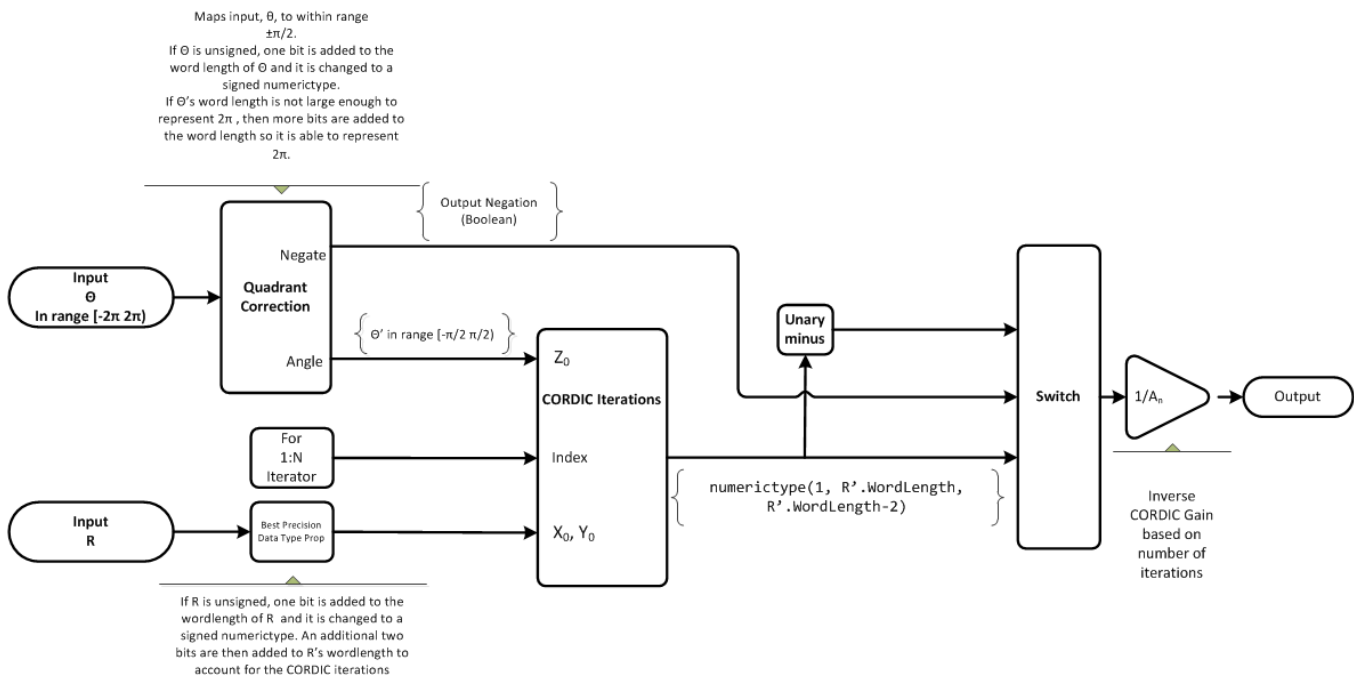

CORDIC Rotation Kernel

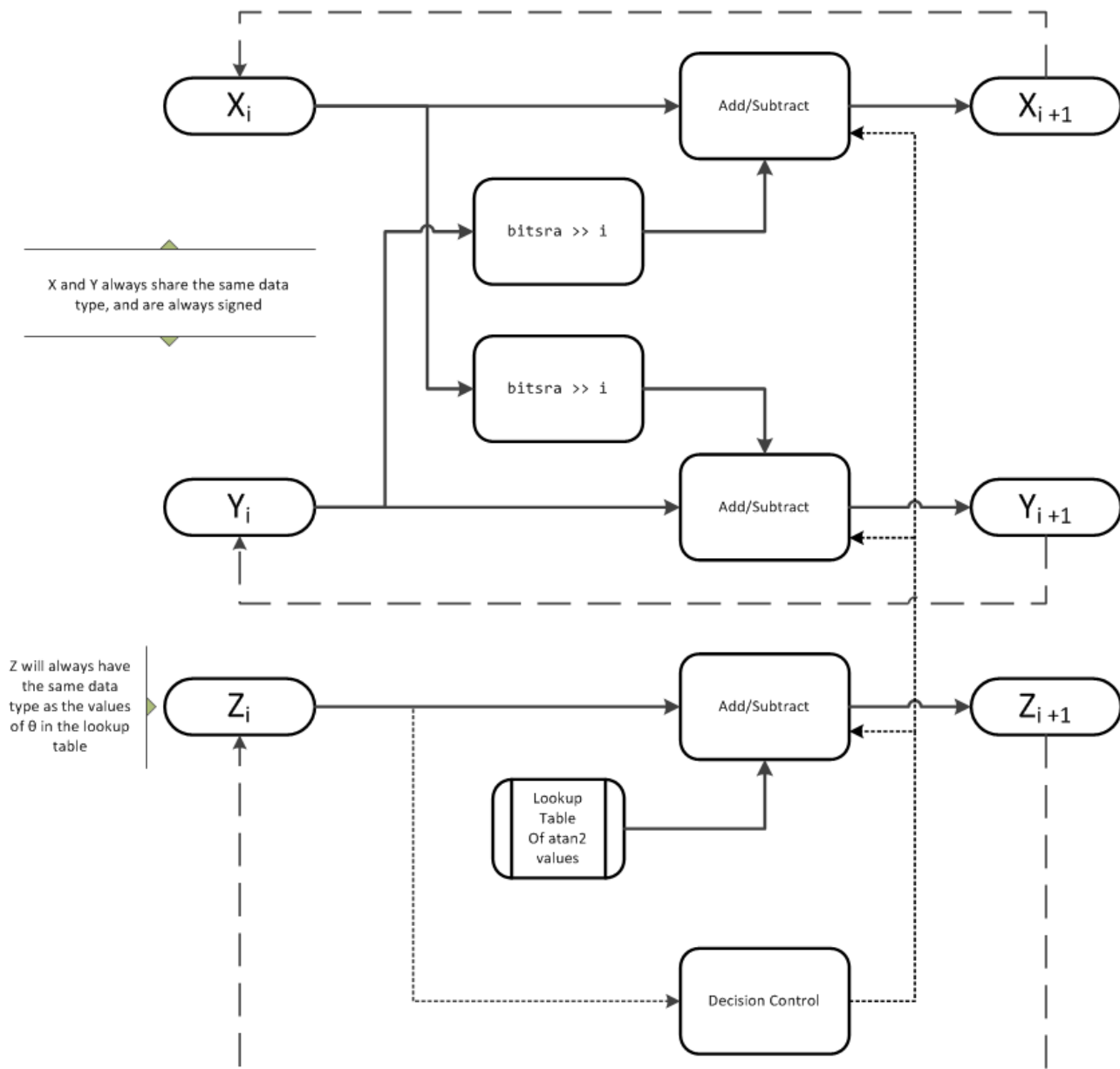

X represents the real part, Y represents the imaginary part, and Z represents theta. This algorithm takes its initial values for X , Y , and Z from the inputs, r and θ .

fimath Propagation Rules

CORDIC functions discard any local `fimath` attached to the input.

The CORDIC functions use their own internal `fimath` when performing calculations:

- OverflowAction—Wrap
- RoundingMethod—Floor

The output has no attached `fimath`.

Extended Capabilities

C/C++ Code Generation

Generate C and C++ code using MATLAB® Coder™.

Usage notes and limitations:

- Variable-size signals are not supported.
- The number of iterations the CORDIC algorithm performs, `niters`, must be a constant.

See Also

`cordicrotate` | `cordicsincos` | `pol2cart`

Introduced in R2011a

cordicrotate

Rotate input using CORDIC-based approximation

Syntax

```
v = cordicrotate(theta,u)
v = cordicrotate(theta,u,niters)
v = cordicrotate(theta,u,Name,Value)
v = cordicrotate(theta,u,niters,Name,Value)
```

Description

`v = cordicrotate(theta,u)` rotates the input `u` by `theta` using a CORDIC algorithm approximation. The function returns the result of $u \cdot e^{j\theta}$.

`v = cordicrotate(theta,u,niters)` performs `niters` iterations of the algorithm.

`v = cordicrotate(theta,u,Name,Value)` scales the output depending on the Boolean value, `b`.

`v = cordicrotate(theta,u,niters,Name,Value)` specifies both the number of iterations and the `Name, Value` pair for whether to scale the output.

Input Arguments

`theta`

`theta` can be a signed or unsigned scalar, vector, matrix, or N -dimensional array containing the angle values in radians. All values of `theta` must be in the range $[-2\pi, 2\pi)$.

`u`

`u` can be a signed or unsigned scalar value or have the same dimensions as `theta`. `u` can be real or complex valued.

`niters`

`niters` is the number of iterations the CORDIC algorithm performs. This argument is optional. When specified, `niters` must be a positive, integer-valued scalar. If you do not specify `niters`, or if you specify a value that is too large, the algorithm uses a maximum value. For fixed-point operation, the maximum number of iterations is the word length of `u` or one less than the word length of `theta`, whichever is smaller. For floating-point operation, the maximum value is 52 for double or 23 for single. Increasing the number of iterations can produce more accurate results, but it also increases the expense of the computation and adds latency.

Name-Value Pair Arguments

Optional comma-separated pairs of `Name, Value` arguments, where `Name` is the argument name and `Value` is the corresponding value. `Name` must appear inside single quotes (' ').

ScaleOutput

`ScaleOutput` is a Boolean value that specifies whether to scale the output by the inverse CORDIC gain factor. This argument is optional. If you set `ScaleOutput` to `true` or `1`, the output values are multiplied by a constant, which incurs extra computations. If you set `ScaleOutput` to `false` or `0`, the output is not scaled.

Default: `true`

Output Arguments

v

`v` contains the approximated result of the CORDIC rotation algorithm. When the input `u` is floating point, the output `v` has the same data type as the input.

When the input `u` is a *signed* integer or fixed point data type, the output `v` is a signed `fi` object. This `fi` object has a word length that is two bits larger than that of `u`. Its fraction length is the same as the fraction length of `u`.

When the input `u` is an *unsigned* integer or fixed point, the output `v` is a signed `fi` object. This `fi` object has a word length that is three bits larger than that of `u`. Its fraction length is the same as the fraction length of `u`.

Examples

Run the following code, and evaluate the accuracy of the CORDIC-based complex rotation.

```
wrdLn = 16;
theta = fi(-pi/3, 1, wrdLn);
u      = fi(0.25 - 7.1i, 1, wrdLn);
uTeTh = double(u) .* exp(1i * double(theta));

fprintf('\n\nNITERS\tReal\t ERROR\t LSBs\t\tImag\tERROR\tLSBs\n');
fprintf('-----\t-----\t -----\t ----\t\t\t-----\t-----\t----\n');
for niters = 1:(wrdLn - 1)
    v_fi = cordicrotate(theta, u, niters);
    v_dbl = double(v_fi);
    x_err = abs(real(v_dbl) - real(uTeTh));
    y_err = abs(imag(v_dbl) - imag(uTeTh));
    fprintf('%d\t%1.4f\t %1.4f\t %1.1f\t\t%1.4f\t %1.4f\t %1.1f\n', ...
        niters, real(v_dbl), x_err, (x_err * pow2(v_fi.FractionLength)), ...
        imag(v_dbl), y_err, (y_err * pow2(v_fi.FractionLength)));
end
fprintf('\n');
```

The output table appears as follows:

NITERS	Real	ERROR	LSBs	Imag	ERROR	LSBs
1	-4.8438	1.1800	4833.5	-5.1973	1.4306	5859.8
2	-6.6567	0.6329	2592.5	-2.4824	1.2842	5260.2
3	-5.8560	0.1678	687.5	-4.0227	0.2560	1048.8
4	-6.3098	0.2860	1171.5	-3.2649	0.5018	2055.2
5	-6.0935	0.0697	285.5	-3.6528	0.1138	466.2

6	-5.9766	0.0472	193.5	-3.8413	0.0746	305.8
7	-6.0359	0.0121	49.5	-3.7476	0.0191	78.2
8	-6.0061	0.0177	72.5	-3.7947	0.0280	114.8
9	-6.0210	0.0028	11.5	-3.7710	0.0043	17.8
10	-6.0286	0.0048	19.5	-3.7590	0.0076	31.2
11	-6.0247	0.0009	3.5	-3.7651	0.0015	6.2
12	-6.0227	0.0011	4.5	-3.7683	0.0017	6.8
13	-6.0237	0.0001	0.5	-3.7666	0.0001	0.2
14	-6.0242	0.0004	1.5	-3.7656	0.0010	4.2
15	-6.0239	0.0001	0.5	-3.7661	0.0005	2.2

More About

CORDIC

CORDIC is an acronym for COordinate Rotation DIGital Computer. The Givens rotation-based CORDIC algorithm is one of the most hardware-efficient algorithms available because it requires only iterative shift-add operations (see References). The CORDIC algorithm eliminates the need for explicit multipliers. Using CORDIC, you can calculate various functions such as sine, cosine, arc sine, arc cosine, arc tangent, and vector magnitude. You can also use this algorithm for divide, square root, hyperbolic, and logarithmic functions.

Increasing the number of CORDIC iterations can produce more accurate results, but doing so increases the expense of the computation and adds latency.

More About

[1] Volder, JE. "The CORDIC Trigonometric Computing Technique." *IRE Transactions on Electronic Computers*. Vol. EC-8, September 1959, pp. 330-334.

[2] Andraka, R. "A survey of CORDIC algorithm for FPGA based computers." *Proceedings of the 1998 ACM/SIGDA sixth international symposium on Field programmable gate arrays*. Feb. 22-24, 1998, pp. 191-200.

[3] Walther, J.S. "A Unified Algorithm for Elementary Functions." Hewlett-Packard Company, Palo Alto. Spring Joint Computer Conference, 1971, pp. 379-386. (from the collection of the Computer History Museum). www.computer.org/csdl/proceedings/afips/1971/5077/00/50770379.pdf

[4] Schelin, Charles W. "Calculator Function Approximation." *The American Mathematical Monthly*. Vol. 90, No. 5, May 1983, pp. 317-325.

Algorithms

Signal Flow Diagrams

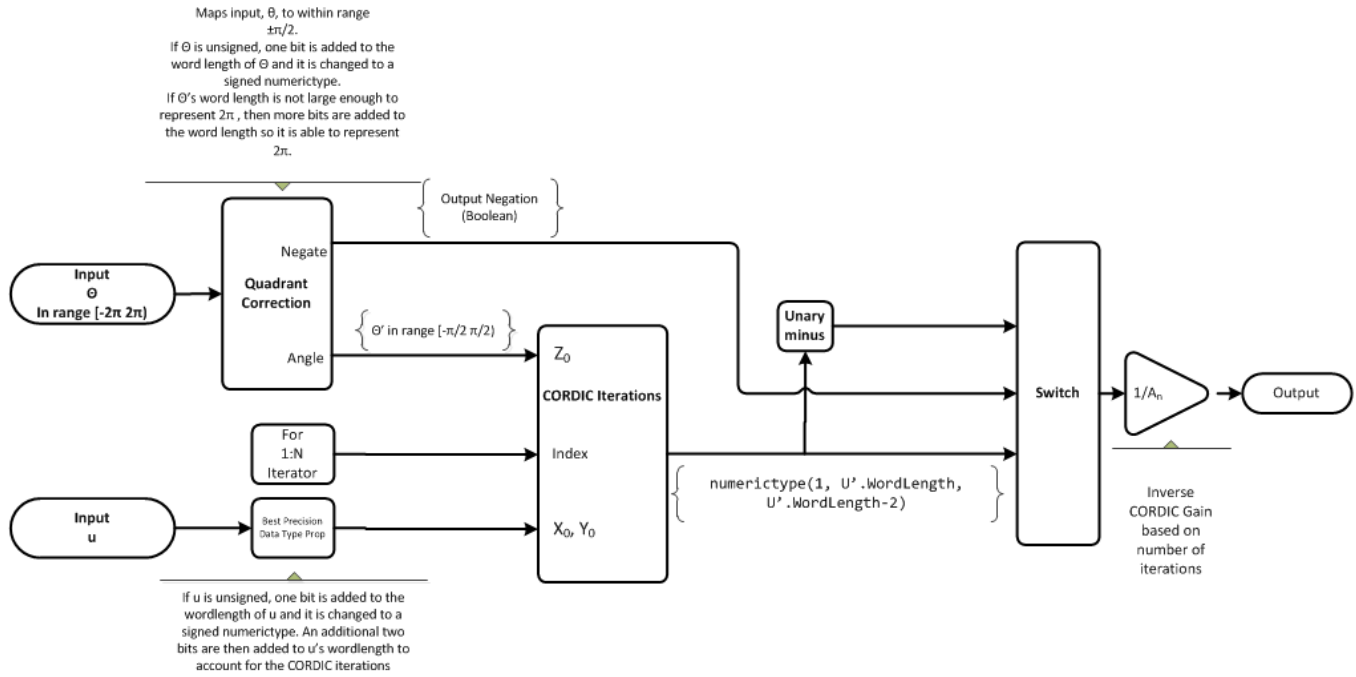

CORDIC Rotation Kernel

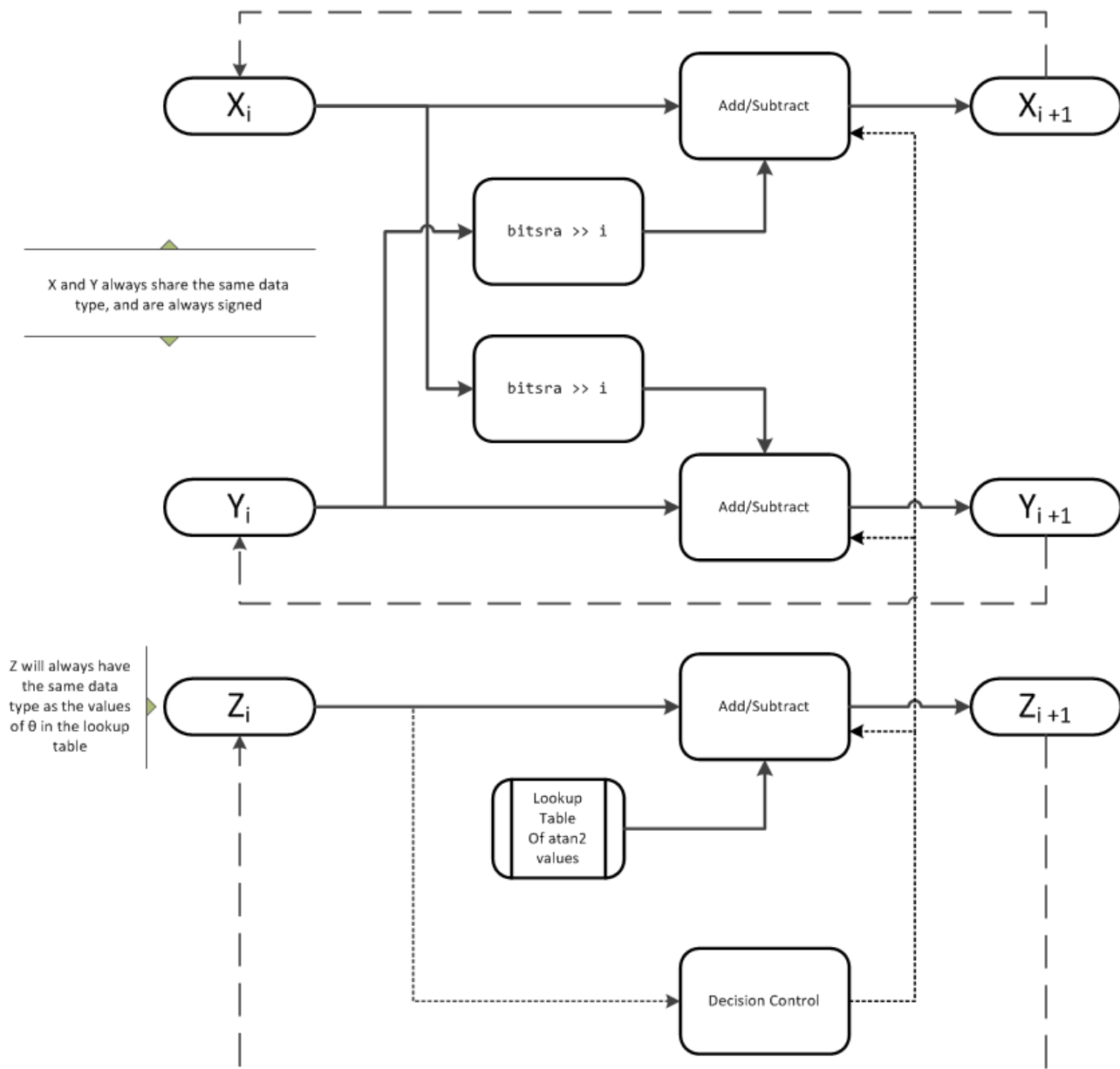

X represents the real part, Y represents the imaginary part, and Z represents theta. This algorithm takes its initial values for X , Y , and Z from the inputs, u and θ .

fimath Propagation Rules

CORDIC functions discard any local `fimath` attached to the input.

The CORDIC functions use their own internal `fimath` when performing calculations:

- `OverflowAction—Wrap`
- `RoundingMethod—Floor`

The output has no attached `fimath`.

Extended Capabilities

C/C++ Code Generation

Generate C and C++ code using MATLAB® Coder™.

Usage notes and limitations:

- Variable-size signals are not supported.
- The number of iterations the CORDIC algorithm performs, `niters`, must be a constant.

See Also

`cordicexp` | `cordicpol2cart`

Introduced in R2011a

cordicsin

CORDIC-based approximation of sine

Syntax

```
y = cordicsin(theta,niters)
```

Description

`y = cordicsin(theta,niters)` computes the sine of `theta` using a “CORDIC” on page 4-285 algorithm approximation.

Input Arguments

theta

`theta` can be a signed or unsigned scalar, vector, matrix, or N-dimensional array containing the angle values in radians. All values of `theta` must be real and in the range $[-2\pi, 2\pi)$.

niters

`niters` is the number of iterations the CORDIC algorithm performs. This is an optional argument. When specified, `niters` must be a positive, integer-valued scalar. If you do not specify `niters` or if you specify a value that is too large, the algorithm uses a maximum value. For fixed-point operation, the maximum number of iterations is one less than the word length of `theta`. For floating-point operation, the maximum value is 52 for double or 23 for single. Increasing the number of iterations can produce more accurate results, but it also increases the expense of the computation and adds latency.

Output Arguments

y

`y` is the CORDIC-based approximation of the sine of `theta`. When the input to the function is floating point, the output data type is the same as the input data type. When the input is fixed point, the output has the same word length as the input, and a fraction length equal to the `WordLength - 2`.

Examples

Compare Results of cordicsin and sin Functions

Compare the results produced by various iterations of the `cordicsin` algorithm to the results of the double-precision `sin` function.

```
% Create 1024 points between [0, 2*pi)
stepSize = pi/512;
thRadDb1 = 0:stepSize:(2*pi - stepSize);
thRadFxp = sfi(thRadDb1, 12);           % signed, 12-bit fixed point
```

```

sinThRef = sin(double(thRadFxp));    % reference results

% Use 12-bit quantized inputs and vary the number of iterations
% from 2 to 10.
% Compare the fixed-point cordicsin function results to the
% results of the double-precision sin function.

for niters = 2:2:10
    cdcSinTh = cordicsin(thRadFxp, niters);
    errCdcRef = sinThRef - double(cdcSinTh);
end

figure
hold on
axis([0 2*pi -1.25 1.25])
plot(thRadFxp, sinThRef, 'b');
plot(thRadFxp, cdcSinTh, 'g');
plot(thRadFxp, errCdcRef, 'r');
ylabel('sin(\Theta)');
gca.XTick = 0:pi/2:2*pi;
gca.XTickLabel = {'0', 'pi/2', 'pi', '3*pi/2', '2*pi'};
gca.YTick = -1:0.5:1;
gca.YTickLabel = {'-1.0', '-0.5', '0', '0.5', '1.0'};
ref_str = 'Reference: sin(double(\Theta))';
cdc_str = sprintf('12-bit CORDIC sine; N = %d', niters);
err_str = sprintf('Error (max = %f)', max(abs(errCdcRef)));
legend(ref_str, cdc_str, err_str);

```

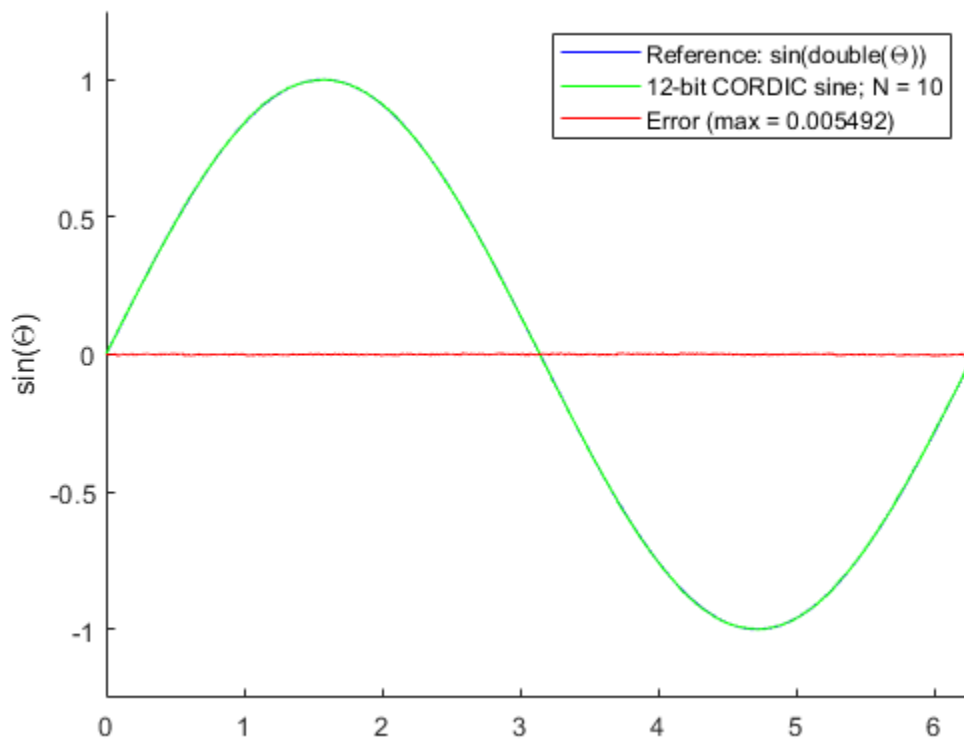

After 10 iterations, the CORDIC algorithm has approximated the sine of θ to within 0.005492 of the double-precision sine result.

More About

CORDIC

CORDIC is an acronym for COordinate Rotation DIgital Computer. The Givens rotation-based CORDIC algorithm is one of the most hardware-efficient algorithms available because it requires only iterative shift-add operations (see References). The CORDIC algorithm eliminates the need for explicit multipliers. Using CORDIC, you can calculate various functions such as sine, cosine, arc sine, arc cosine, arc tangent, and vector magnitude. You can also use this algorithm for divide, square root, hyperbolic, and logarithmic functions.

Increasing the number of CORDIC iterations can produce more accurate results, but doing so increases the expense of the computation and adds latency.

More About

[1] Volder, JE. "The CORDIC Trigonometric Computing Technique." *IRE Transactions on Electronic Computers*. Vol. EC-8, September 1959, pp. 330-334.

[2] Andraka, R. "A survey of CORDIC algorithm for FPGA based computers." *Proceedings of the 1998 ACM/SIGDA sixth international symposium on Field programmable gate arrays*. Feb. 22-24, 1998, pp. 191-200.

[3] Walther, J.S. "A Unified Algorithm for Elementary Functions." Hewlett-Packard Company, Palo Alto. Spring Joint Computer Conference, 1971, pp. 379-386. (from the collection of the Computer History Museum). www.computer.org/csdl/proceedings/afips/1971/5077/00/50770379.pdf

[4] Schelin, Charles W. "Calculator Function Approximation." *The American Mathematical Monthly*. Vol. 90, No. 5, May 1983, pp. 317-325.

Algorithms

Signal Flow Diagrams

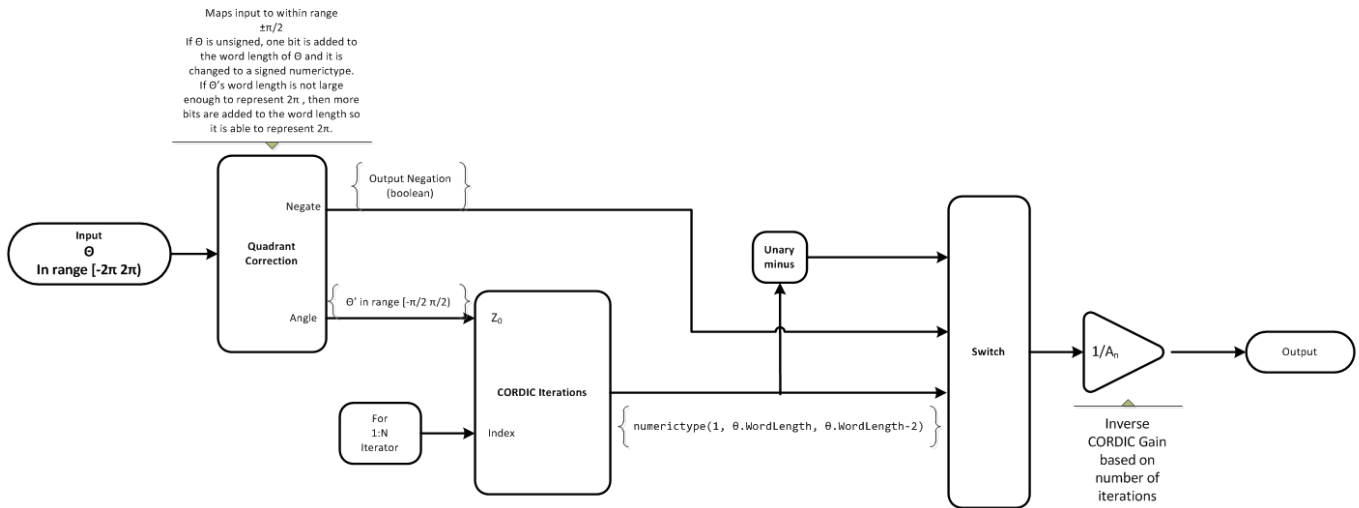

CORDIC Rotation Kernel

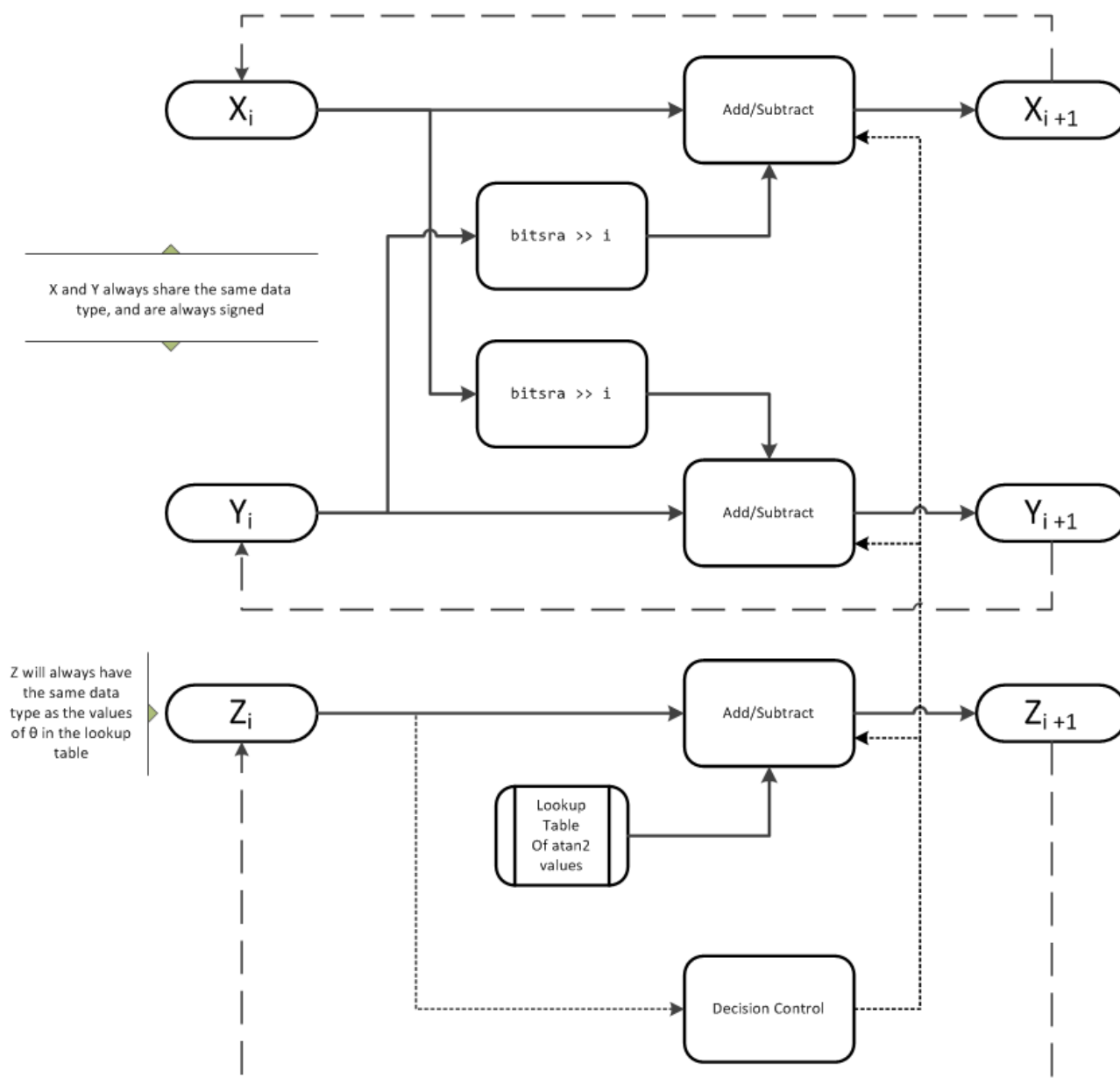

X represents the sine, Y represents the cosine, and Z represents theta. The accuracy of the CORDIC rotation kernel depends on the choice of initial values for X , Y , and Z . This algorithm uses the following initial values:

z_0 is initialized to the θ input argument value

x_0 is initialized to $\frac{1}{A_N}$

y_0 is initialized to 0

fimath Propagation Rules

CORDIC functions discard any local `fimath` attached to the input.

The CORDIC functions use their own internal `fimath` when performing calculations:

- `OverflowAction`—`Wrap`
- `RoundingMethod`—`Floor`

The output has no attached `fimath`.

Extended Capabilities**C/C++ Code Generation**

Generate C and C++ code using MATLAB® Coder™.

Usage notes and limitations:

- Variable-size signals are not supported.
- The number of iterations the CORDIC algorithm performs, `nIters`, must be a constant.

See Also

`cordiccxp` | `cordiccos` | `cordicsincos` | `cos` | `sin`

Topics

“Calculate Fixed-Point Sine and Cosine”

“Calculate Fixed-Point Arctangent”

Introduced in R2010a

cordicsincos

CORDIC-based approximation of sine and cosine

Syntax

```
[y, x] = cordicsincos(theta, niters)
```

Description

`[y, x] = cordicsincos(theta, niters)` computes the sine and cosine of `theta` using a “CORDIC” on page 4-290 algorithm approximation. `y` contains the approximated sine result, and `x` contains the approximated cosine result.

Input Arguments

`theta`

`theta` can be a signed or unsigned scalar, vector, matrix, or N-dimensional array containing the angle values in radians. All values of `theta` must be real and in the range $[-2\pi, 2\pi]$. When `theta` has a fixed-point data type, it must be signed.

`niters`

`niters` is the number of iterations the CORDIC algorithm performs. This is an optional argument. When specified, `niters` must be a positive, integer-valued scalar. If you do not specify `niters` or if you specify a value that is too large, the algorithm uses a maximum value. For fixed-point operation, the maximum number of iterations is one less than the word length of `theta`. For floating-point operation, the maximum value is 52 for double or 23 for single. Increasing the number of iterations can produce more accurate results, but it also increases the expense of the computation and adds latency.

Output Arguments

`y`

CORDIC-based approximated sine of `theta`. When the input to the function is floating point, the output data type is the same as the input data type. When the input is fixed point, the output has the same word length as the input, and a fraction length equal to the `WordLength - 2`.

`x`

CORDIC-based approximated cosine of `theta`. When the input to the function is floating point, the output data type is the same as the input data type. When the input is fixed point, the output has the same word length as the input, and a fraction length equal to the `WordLength - 2`.

Examples

The following example illustrates the effect of the number of iterations on the result of the `cordicsincos` approximation.

```

wrdLn = 8;
theta = fi(pi/2, 1, wrdLn);
fprintf('\n\nNITERS\t\tY (SIN)\t ERROR\t LSBs\t\tX (COS)\t ERROR\t LSBs\n');
fprintf('-----\t\t-----\t -----\t ----\t\t-----\t -----\t ----\n');
for niters = 1:(wrdLn - 1)
    [y, x] = cordicsincos(theta, niters);
    y_FL = y.FractionLength;
    y_dbl = double(y);
    x_dbl = double(x);
    y_err = abs(y_dbl - sin(double(theta)));
    x_err = abs(x_dbl - cos(double(theta)));
    fprintf(' %d\t\t%1.4f\t %1.4f\t %1.1f\t\t%1.4f\t %1.4f\t %1.1f\n', ...
        niters, y_dbl, y_err, (y_err * pow2(y_FL)), x_dbl, x_err, ...
        (x_err * pow2(y_FL)));
end
fprintf('\n');

```

The output table appears as follows:

NITERS	Y (SIN)	ERROR	LSBs	X (COS)	ERROR	LSBs
-----	-----	-----	----	-----	-----	----
1	0.7031	0.2968	19.0	0.7031	0.7105	45.5
2	0.9375	0.0625	4.0	0.3125	0.3198	20.5
3	0.9844	0.0156	1.0	0.0938	0.1011	6.5
4	0.9844	0.0156	1.0	-0.0156	0.0083	0.5
5	1.0000	0.0000	0.0	0.0312	0.0386	2.5
6	1.0000	0.0000	0.0	0.0000	0.0073	0.5
7	1.0000	0.0000	0.0	0.0156	0.0230	1.5

More About

CORDIC

CORDIC is an acronym for COordinate Rotation DIGital Computer. The Givens rotation-based CORDIC algorithm is one of the most hardware-efficient algorithms available because it requires only iterative shift-add operations (see References). The CORDIC algorithm eliminates the need for explicit multipliers. Using CORDIC, you can calculate various functions such as sine, cosine, arc sine, arc cosine, arc tangent, and vector magnitude. You can also use this algorithm for divide, square root, hyperbolic, and logarithmic functions.

Increasing the number of CORDIC iterations can produce more accurate results, but doing so increases the expense of the computation and adds latency.

More About

[1] Volder, JE. "The CORDIC Trigonometric Computing Technique." *IRE Transactions on Electronic Computers*. Vol. EC-8, September 1959, pp. 330-334.

[2] Andraka, R. "A survey of CORDIC algorithm for FPGA based computers." *Proceedings of the 1998 ACM/SIGDA sixth international symposium on Field programmable gate arrays*. Feb. 22-24, 1998, pp. 191-200.

[3] Walther, J.S. "A Unified Algorithm for Elementary Functions." Hewlett-Packard Company, Palo Alto. Spring Joint Computer Conference, 1971, pp. 379-386. (from the collection of the Computer History Museum). www.computer.org/csdl/proceedings/afips/1971/5077/00/50770379.pdf

[4] Schelin, Charles W. "Calculator Function Approximation." *The American Mathematical Monthly*. Vol. 90, No. 5, May 1983, pp. 317-325.

Algorithms

Signal Flow Diagrams

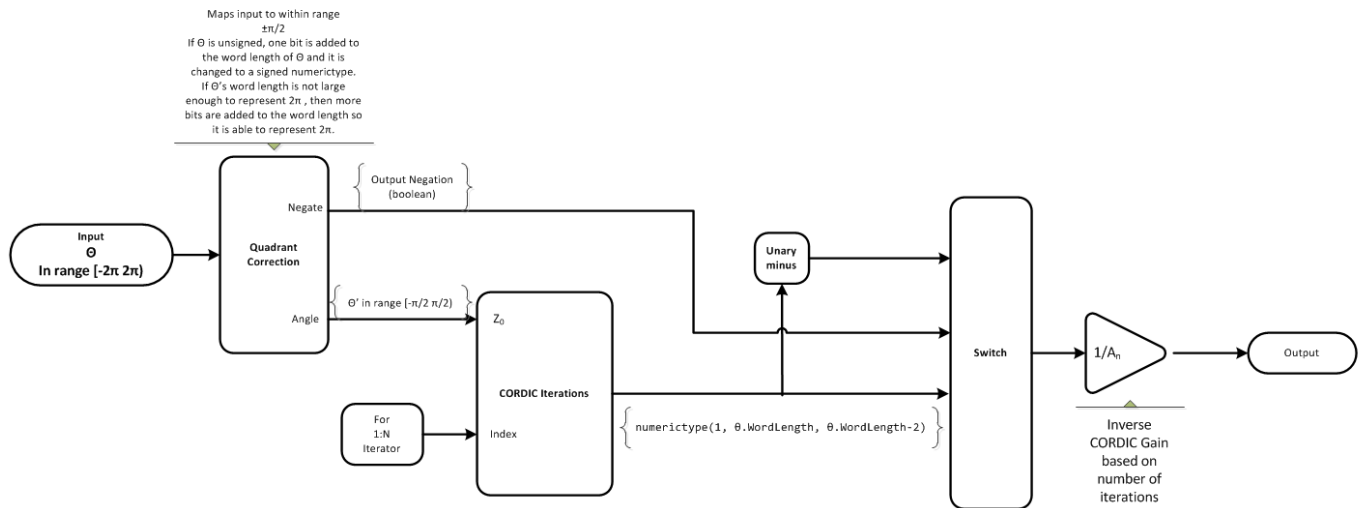

CORDIC Rotation Kernel

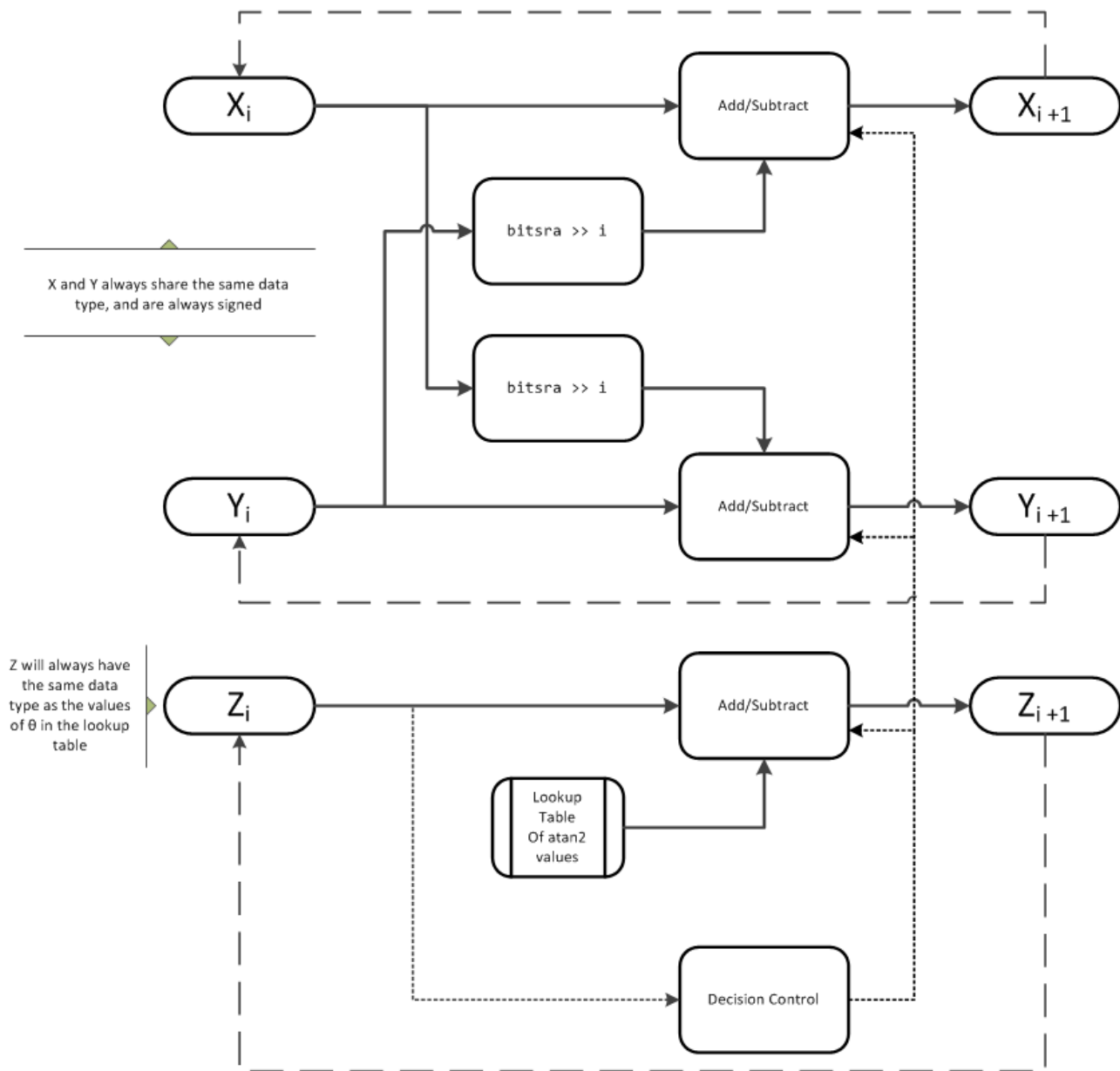

X represents the sine, Y represents the cosine, and Z represents theta. The accuracy of the CORDIC rotation kernel depends on the choice of initial values for X , Y , and Z . This algorithm uses the following initial values:

z_0 is initialized to the θ input argument value

x_0 is initialized to $\frac{1}{A_N}$

y_0 is initialized to 0

fimath Propagation Rules

CORDIC functions discard any local `fimath` attached to the input.

The CORDIC functions use their own internal `fimath` when performing calculations:

- `OverflowAction`—`Wrap`
- `RoundingMethod`—`Floor`

The output has no attached `fimath`.

Extended Capabilities

C/C++ Code Generation

Generate C and C++ code using MATLAB® Coder™.

Usage notes and limitations:

- Variable-size signals are not supported.
- The number of iterations the CORDIC algorithm performs, `nIters`, must be a constant.

See Also

`cordiccxp` | `cordiccos` | `cordicsin`

Topics

“Calculate Fixed-Point Sine and Cosine”

“Calculate Fixed-Point Arctangent”

Introduced in R2010a

cordicsqrt

CORDIC-based approximation of square root

Syntax

```
y=cordicsqrt(u)
y=cordicsqrt(u, niters)
y=cordicsqrt( ____, 'ScaleOutput', B)
```

Description

`y=cordicsqrt(u)` computes the square root of `u` using a CORDIC algorithm implementation.

`y=cordicsqrt(u, niters)` computes the square root of `u` by performing `niters` iterations of the CORDIC algorithm.

`y=cordicsqrt(____, 'ScaleOutput', B)` scales the output depending on the Boolean value of `B`.

Examples

Calculate the CORDIC Square Root

Find the square root of `fi` object `x` using a CORDIC implementation.

```
x = fi(1.6,1,12);
y = cordicsqrt(x)
```

```
y =
    1.2646
```

```
        DataTypeMode: Fixed-point: binary point scaling
        Signedness: Signed
        WordLength: 12
        FractionLength: 10
```

Because you did not specify `niters`, the function performs the maximum number of iterations, `x.WordLength - 1`.

Compute the difference between the results of the `cordicsqrt` function and the double-precision `sqrt` function.

```
err = abs(sqrt(double(x))-double(y))
err = 1.0821e-04
```

Calculate the CORDIC Square Root With a Specified Number of Iterations

Compute the square root of `x` with three iterations of the CORDIC kernel.

```

x = fi(1.6,1,12);
y = cordicsqrt(x,3)

y =
    1.2646

    DataTypeMode: Fixed-point: binary point scaling
    Signedness: Signed
    WordLength: 12
    FractionLength: 10

```

Compute the difference between the results of the `cordicsqrt` function and the double-precision `sqrt` function.

```

err = abs(sqrt(double(x))-double(y))

err = 1.0821e-04

```

Calculate the CORDIC Square Root Without Scaling the Output

```

x = fi(1.6,1,12);
y = cordicsqrt(x, 'ScaleOutput', 0)

y =
    1.0479

    DataTypeMode: Fixed-point: binary point scaling
    Signedness: Signed
    WordLength: 12
    FractionLength: 10

```

The output, `y`, was not scaled by the inverse CORDIC gain factor.

Compare Results of `cordicsqrt` and `sqrt` Functions

Compare the results produced by 10 iterations of the `cordicsqrt` algorithm to the results of the double-precision `sqrt` function.

```

% Create 500 points between [0, 2)
stepSize = 2/500;
Xdbl = 0:stepSize:2;
XFxp = fi(Xdbl, 1, 12); % signed, 12-bit fixed-point
sqrtXRef = sqrt(double(XFxp)); % reference results

% Use 12-bit quantized inputs and set the number
% of iterations to 10.
% Compare the fixed-point CORDIC results to the
% double-precision sqrt function results.

nitters = 10;
cdcSqrtX = cordicsqrt(XFxp, nitters);
errCdcRef = sqrtXRef - double(cdcSqrtX);
figure

```

```

hold on
axis([0 2 -.5 1.5])
plot(XFxp, sqrtXRef, 'b')
plot(XFxp, cdcSqrtX, 'g')
plot(XFxp, errCdcRef, 'r')
ylabel('Sqrt(x)')
gca.XTick = 0:0.25:2;
gca.XTickLabel = {'0', '0.25', '0.5', '0.75', '1', '1.25', '1.5', '1.75', '2'};
gca.YTick = -.5:.25:1.5;
gca.YTickLabel = {'-0.5', '-0.25', '0', '0.25', '0.5', '0.75', '1', '1.25', '1.5'};
ref_str = 'Reference: sqrt(double(X))';
cdc_str = sprintf('12-bit CORDIC square root; N = %d', niters);
err_str = sprintf('Error (max = %f)', max(abs(errCdcRef)));
legend(ref_str, cdc_str, err_str, 'Location', 'southeast')

```

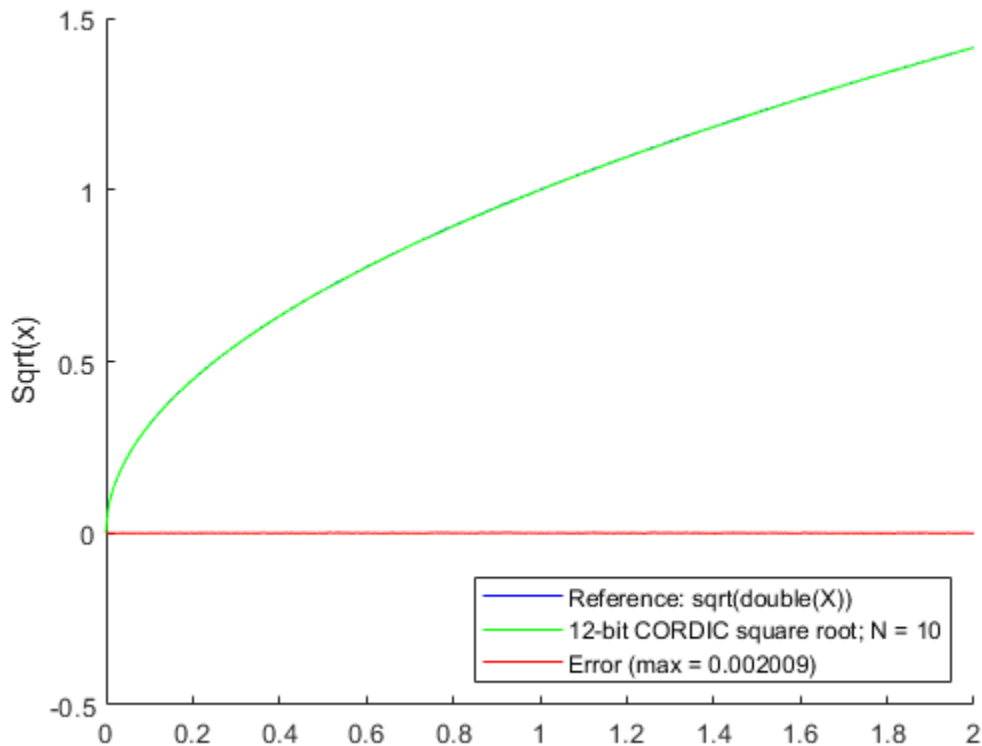

Input Arguments

u — Data input array

scalar | vector | matrix | multidimensional array

Data input array, specified as a positive scalar, vector, matrix, or multidimensional array of fixed-point or built-in data types. When the input array contains values between 0.5 and 2, the algorithm is most accurate. A pre- and post-normalization process is performed on input values outside of this range. For more information on this process, see “Pre- and Post-Normalization” on page 4-299.

Data Types: fi|single | double | int8 | int16 | int32 | int64 | uint8 | uint16 | uint32 | uint64

niters — Number of iterations

scalar

The number of iterations that the CORDIC algorithm performs, specified as a positive, integer-valued scalar. If you do not specify `niters`, the algorithm uses a default value. For fixed-point inputs, the default value of `niters` is `u.WordLength - 1`. For floating-point inputs, the default value of `niters` is 52 for double precision; 23 for single precision.

Data Types: fi|single | double | int8 | int16 | int32 | int64 | uint8 | uint16 | uint32 | uint64

Name-Value Pair Arguments

Specify optional comma-separated pairs of `Name`, `Value` arguments. `Name` is the argument name and `Value` is the corresponding value. `Name` must appear inside quotes. You can specify several name and value pair arguments in any order as `Name1, Value1, ..., NameN, ValueN`.

Example: `y= cordicsqrt(x, 'ScaleOutput', 0)`

ScaleOutput — Whether to scale the output

true (default) | false

Boolean value that specifies whether to scale the output by the inverse CORDIC gain factor. If you set `ScaleOutput` to `true` or `1`, the output values are multiplied by a constant, which incurs extra computations. If you set `ScaleOutput` to `false` or `0`, the output is not scaled.

Data Types: logical

Output Arguments

y — Output array

scalar | vector | matrix | multidimensional array

Output array, returned as a scalar, vector, matrix, or multidimensional array.

More About

CORDIC

CORDIC is an acronym for COordinate Rotation DIgital Computer. The Givens rotation-based CORDIC algorithm is one of the most hardware-efficient algorithms available because it requires only iterative shift-add operations (see References). The CORDIC algorithm eliminates the need for explicit multipliers. Using CORDIC, you can calculate various functions such as sine, cosine, arc sine, arc cosine, arc tangent, and vector magnitude. You can also use this algorithm for divide, square root, hyperbolic, and logarithmic functions.

Increasing the number of CORDIC iterations can produce more accurate results, but doing so increases the expense of the computation and adds latency.

Algorithms

Signal Flow Diagrams

Fraction bits are added to the data type of u in order to represent $u \pm .25$.
 u is then normalized to within the range $[-.5, .2)$.
 If needed, bits are then added to the word length of u to prevent overflows during the CORDIC iterations.

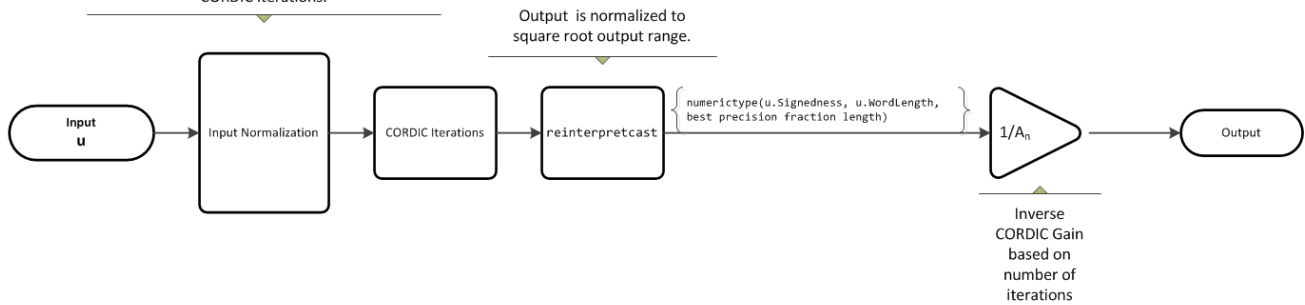

For further details on the pre- and post-normalization process, see “Pre- and Post-Normalization” on page 4-299.

CORDIC Hyperbolic Kernel

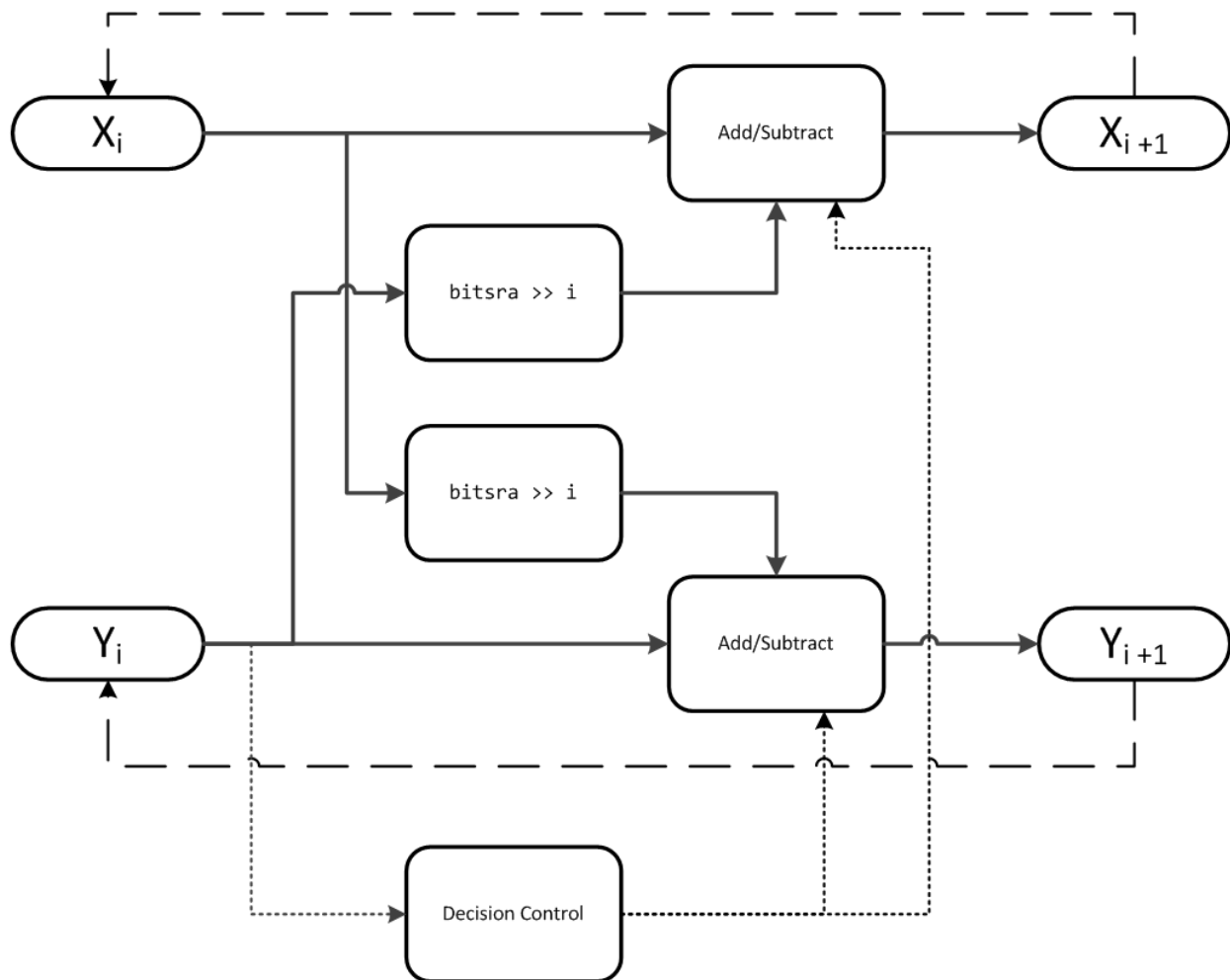

X is initialized to $u' + .25$, and Y is initialized to $u' - .25$, where u' is the normalized function input.

With repeated iterations of the CORDIC hyperbolic kernel, X approaches $A_N\sqrt{u'}$, where A_N represents the CORDIC gain. Y approaches θ .

Pre- and Post-Normalization

For input values outside of the range of $[0.5, 2)$ a pre- and post-normalization process occurs. This process performs bitshifts on the input array before passing it to the CORDIC kernel. The result is then shifted back into the correct output range during the post-normalization stage. For more details on this process see "Overcoming Algorithm Input Range Limitations" in "Compute Square Root Using CORDIC".

fimath Propagation Rules

CORDIC functions discard any local `fimath` attached to the input.

The CORDIC functions use their own internal `fimath` when performing calculations:

- `OverflowAction—Wrap`
- `RoundingMethod—Floor`

The output has no attached `fimath`.

References

- [1] Volder, JE. "The CORDIC Trigonometric Computing Technique." *IRE Transactions on Electronic Computers*. Vol. EC-8, September 1959, pp. 330-334.
- [2] Andraka, R. "A survey of CORDIC algorithm for FPGA based computers." *Proceedings of the 1998 ACM/SIGDA sixth international symposium on Field programmable gate arrays*. Feb. 22-24, 1998, pp. 191-200.
- [3] Walther, J.S. "A Unified Algorithm for Elementary Functions." Hewlett-Packard Company, Palo Alto. Spring Joint Computer Conference, 1971, pp. 379-386. (from the collection of the Computer History Museum). www.computer.org/csdl/proceedings/afips/1971/5077/00/50770379.pdf
- [4] Schelin, Charles W. "Calculator Function Approximation." *The American Mathematical Monthly*. Vol. 90, No. 5, May 1983, pp. 317-325.

Extended Capabilities

C/C++ Code Generation

Generate C and C++ code using MATLAB® Coder™.

Usage notes and limitations:

- Variable-size signals are not supported.
- The number of iterations the CORDIC algorithm performs, `niters`, must be a constant.

See Also

`sqrt`

Topics

"Compute Square Root Using CORDIC"

Introduced in R2014a

cordictanh

CORDIC-based hyperbolic tangent

Syntax

```
T = cordictanh(theta)
T = cordictanh(theta, niters)
```

Description

`T = cordictanh(theta)` returns the hyperbolic tangent of `theta`.

`T = cordictanh(theta, niters)` returns the hyperbolic tangent of `theta` by performing `niters` iterations of the CORDIC algorithm.

Examples

Compute CORDIC Hyperbolic Tangent

Find the hyperbolic tangent of `fi` object `theta` using a CORDIC implementation with the default number of iterations.

```
theta = fi(-2*pi:.1:2*pi-.1);
T_cordic = cordictanh(theta);
```

Plot the hyperbolic tangent of `theta` using the `tanh` function and its CORDIC approximation.

```
T = tanh(double(theta));
plot(theta, T_cordic);
hold on;
plot(theta, T);
legend('CORDIC approximation of tanh', 'tanh');
xlabel('theta');
ylabel('tanh(theta)');
```

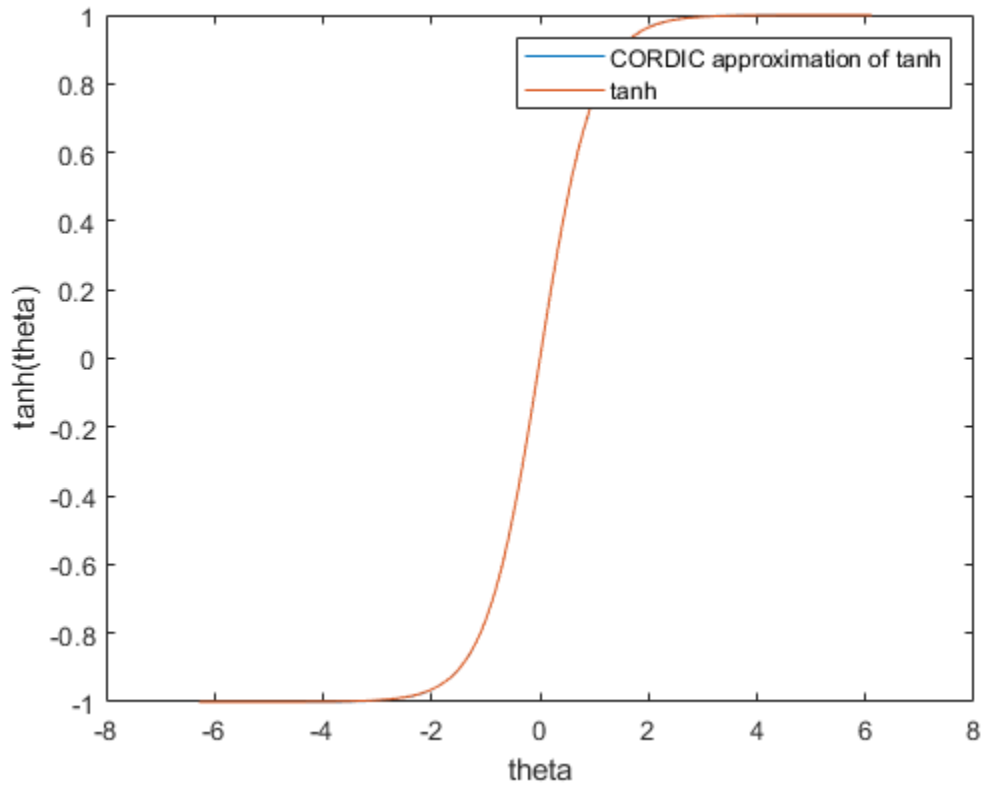

Compute the difference between the results of the cordictanh function and the tanh function.

```
figure;  
err = abs(T - double(T_cordic));  
plot(theta, err);  
xlabel('theta');  
ylabel('error');
```

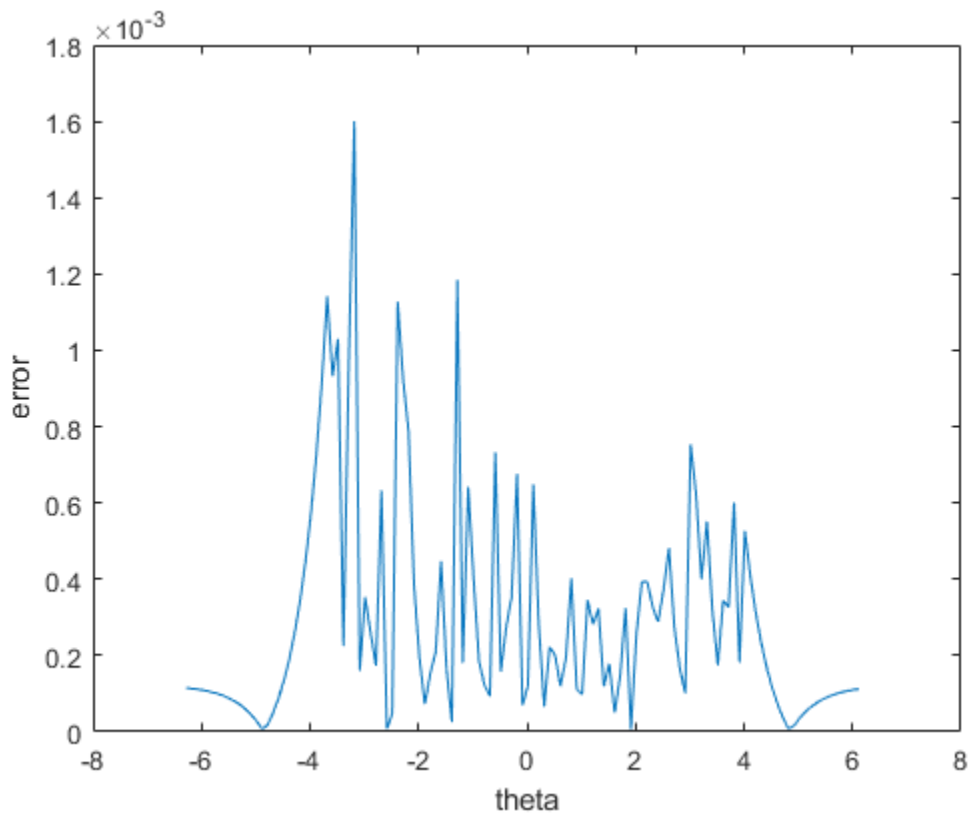
Compute CORDIC Hyperbolic Tangent with Specified Number of Iterations

Find the hyperbolic tangent of `fi` object `theta` using a CORDIC implementation and specify the number of iterations the CORDIC kernel should perform. Plot the CORDIC approximation of the hyperbolic tangent of `theta` with varying numbers of iterations.

```
theta = fi(-2*pi:.1:2*pi-.1);
for niters = 5:10:25
T_cordic = cordictanh(theta, niters);
plot(theta, T_cordic);
hold on;
end
xlabel('theta');
ylabel('tanh(theta)');
legend('5 iterations', '15 iterations', '25 iterations', 'Location', 'southeast');
```

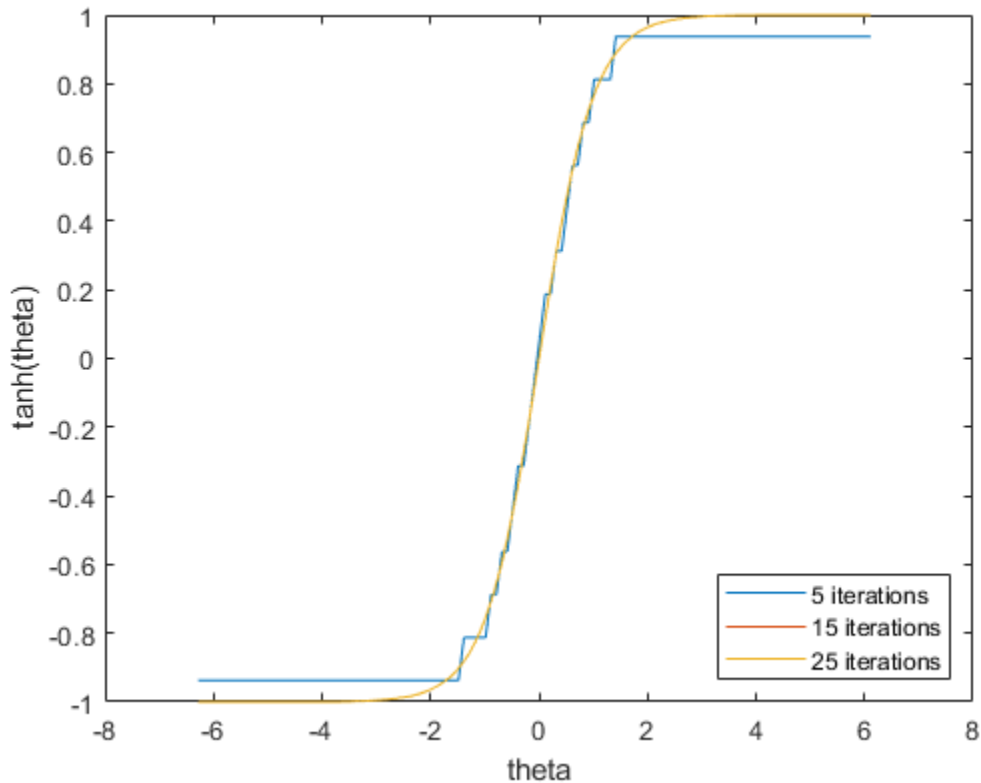

Input Arguments

theta — angle values

scalar | vector | matrix | n-dimensional array

Angle values in radians specified as a scalar, vector, matrix, or N-dimensional array.

Data Types: single | double | int8 | int16 | int32 | int64 | uint8 | uint16 | uint32 | uint64 | fi

niters — Number of iterations

scalar

The number of iterations that the CORDIC algorithm performs, specified as a positive, integer-valued scalar. If you do not specify `niters`, the algorithm uses a default value. For fixed-point inputs, the default value of `niters` is one less than the word length of the input array, `theta`. For double-precision inputs, the default value of `niters` is 52. For single-precision inputs, the default value is 23.

Data Types: single | double | int8 | int16 | int32 | int64 | uint8 | uint16 | uint32 | uint64 | fi

Output Arguments

T — Output array

scalar | vector | matrix | n-dimensional array

T is the CORDIC-based approximation of the hyperbolic tangent of theta. When the input to the function is floating point, the output data type is the same as the input data type. When the input is fixed point, the output has the same word length as the input, and a fraction length equal to the `WordLength - 2`.

See Also

`cordicatan2` | `cordiccos` | `cordicsin` | `tanh`

Introduced in R2017b

COS

Cosine of `fi` object

Syntax

```
y = cos(theta)
```

Description

`y = cos(theta)` returns the cosine on page 4-307 of `fi` input `theta` using a table-lookup algorithm.

Input Arguments

`theta`

`theta` can be a real-valued, signed or unsigned scalar, vector, matrix, or N-dimensional array containing the fixed-point angle values in radians. Valid data types of `theta` are:

- `fi` single
- `fi` double
- `fi` fixed-point with binary point scaling
- `fi` scaled double with binary point scaling

Output Arguments

`y`

`y` is the cosine of `theta`. `y` is a signed, fixed-point number in the range [-1,1]. It has a 16-bit word length and 15-bit fraction length (`numericType(1,16,15)`).

Examples

Calculate the cosine of fixed-point input values.

```
theta = fi([0,pi/4,pi/3,pi/2,(2*pi)/3,(3*pi)/4,pi])
theta =
    0    0.7854    1.0472    1.5708    2.0944    2.3562    3.1416
      DataTypeMode: Fixed-point: binary point scaling
      Signedness: Signed
      WordLength: 16
      FractionLength: 13
```

```
y = cos(theta)
```

```
y =
```

```
1.0000  0.7072  0.4999  0.0001 -0.4999 -0.7070 -1.0000
```

```
DataTypeMode: Fixed-point: binary point scaling
Signedness: Signed
WordLength: 16
FractionLength: 15
```

More About

Cosine

The cosine of angle Θ is defined as

$$\cos(\theta) = \frac{e^{i\theta} + e^{-i\theta}}{2}$$

Algorithms

The `cos` function computes the cosine of fixed-point input using an 8-bit lookup table as follows:

- 1 Perform a modulo 2π , so the input is in the range $[0, 2\pi)$ radians.
- 2 Cast the input to a 16-bit stored integer value, using the 16 most-significant bits.
- 3 Compute the table index, based on the 16-bit stored integer value, normalized to the full `uint16` range.
- 4 Use the 8 most-significant bits to obtain the first value from the table.
- 5 Use the next-greater table value as the second value.
- 6 Use the 8 least-significant bits to interpolate between the first and second values, using nearest-neighbor linear interpolation.

fimath Propagation Rules

The `cos` function ignores and discards any `fimath` attached to the input, `theta`. The output, `y`, is always associated with the default `fimath`.

Extended Capabilities

C/C++ Code Generation

Generate C and C++ code using MATLAB® Coder™.

See Also

`angle` | `atan2` | `cordiccos` | `cordicsin` | `cos` | `sin`

Topics

“Calculate Fixed-Point Sine and Cosine”

Introduced in R2012a

ctranspose

Complex conjugate transpose of `fi` object

Syntax

`ctranspose(a)`

Description

This function accepts `fi` objects as inputs.

`ctranspose(a)` returns the complex conjugate transpose of `fi` object `a`. It is also called for the syntax `a'`.

Extended Capabilities

C/C++ Code Generation

Generate C and C++ code using MATLAB® Coder™.

HDL Code Generation

Generate Verilog and VHDL code for FPGA and ASIC designs using HDL Coder™.

See Also

Introduced before R2006a

CustomFloat

Numeric object with a custom floating-point data type

Description

Use a `CustomFloat` object to define a floating-point numeric data type with specified word length and mantissa length. Floating-point data types defined by a `CustomFloat` object adhere to the IEEE 754-2008 standard. For more information on floating-point data types, see “Floating-Point Numbers”.

Creation

Syntax

```
x = CustomFloat(v)
x = CustomFloat(v, type)
x = CustomFloat(v, WordLength, MantissaLength)
x = CustomFloat(v, WordLength, MantissaLength, 'typecast')
x = CustomFloat(cf)
```

Description

`x = CustomFloat(v)` returns a `CustomFloat` object with value `v`. The output object has the same word length, mantissa length, and exponent length as input `v`.

`x = CustomFloat(v, type)` returns a `CustomFloat` object with value `v` and floating-point type specified by `type`.

`x = CustomFloat(v, WordLength, MantissaLength)` returns a `CustomFloat` object with the specified word length and mantissa length.

`x = CustomFloat(v, WordLength, MantissaLength, 'typecast')` returns a `CustomFloat` object with the bit pattern of `v` and the specified mantissa length. The word length must match the word length of the input `v`.

`x = CustomFloat(cf)` returns a `CustomFloat` object with value and data type properties of `CustomFloat` object `cf`.

Input Arguments

v — Value of object

scalar | vector | matrix | multi-dimensional array

The value of the `CustomFloat` object, specified as a scalar, vector, matrix, or multi-dimensional array.

Data Types: half | single | double | int8 | int16 | int32 | int64 | uint8 | uint16 | uint32 | uint64 | fi

type — Floating-point type of object

'double' | 'single' | 'half'

Floating-point data type of CustomFloat object, specified as either 'double', 'single', or 'half'.

The properties of these types are summarized in the following table.

Type	Word Length	Mantissa Length
double	64	52
single	32	23
half	16	10

Data Types: char

cf — Custom floating-point type

CustomFloat object

Custom floating-point type, specified as a CustomFloat object.

Properties**ExponentBias — Offset value for the exponent**

scalar integer

Scalar integer representing the offset value for the exponent.

This property cannot be changed directly, however you can change this property by changing the WordLength and MantissaLength properties, which influence the ExponentLength property. The ExponentBias for a floating-point data type is computed through the following equation:

$$\text{ExponentBias} = 2^{e-1} - 1 \quad (4-6)$$

where e represents the ExponentLength.

Data Types: double

ExponentLength — Number of bits representing the exponent

scalar integer less than 31

Number of bits representing the exponent. You cannot edit this property directly, however you can change the exponent length by changing the MantissaLength and WordLength properties.

The ExponentLength, MantissaLength, and WordLength properties are related through the following equation:

$$\text{WordLength} = 1 + \text{MantissaLength} + \text{ExponentLength} \quad (4-7)$$

ExponentLength must be less than 31 bits.

Data Types: double

MantissaLength — Number of bits representing the mantissa

scalar integer

Number of bits representing the mantissa, specified as a scalar integer.

The `ExponentLength`, `MantissaLength`, and `WordLength` properties are related through the following equation.

$$\text{WordLength} = 1 + \text{MantissaLength} + \text{ExponentLength} \quad (4-8)$$

Note `ExponentLength` must be less than 31 bits.

Example: `custfloat.MantissaLength = 14;`

Data Types: `single` | `double` | `int8` | `int16` | `int32` | `int64` | `uint8` | `uint16` | `uint32` | `uint64` | `fi`

WordLength — Total number of bits in the data type

scalar integer

Total number of bits in the data type, specified as a scalar integer.

The `ExponentLength`, `MantissaLength`, and `WordLength` properties are related through the following equation.

$$\text{WordLength} = 1 + \text{MantissaLength} + \text{ExponentLength} \quad (4-9)$$

Note `ExponentLength` must be less than 31 bits.

Example: `custfloat.WordLength = 28;`

Data Types: `single` | `double` | `int8` | `int16` | `int32` | `int64` | `uint8` | `uint16` | `uint32` | `uint64` | `fi`

Object Functions

Math and Arithmetic

<code>abs</code>	Absolute value and complex magnitude
<code>ceil</code>	Round toward positive infinity
<code>complex</code>	Create complex array
<code>conj</code>	Complex conjugate
<code>cosh</code>	Hyperbolic cosine
<code>exp</code>	Exponential
<code>fix</code>	Round toward zero
<code>floor</code>	Round toward negative infinity
<code>fma</code>	Multiply and add using fused multiply add approach
<code>hypot</code>	Square root of sum of squares (hypotenuse)
<code>ldivide</code>	Left array division
<code>log</code>	Natural logarithm
<code>log2</code>	Base 2 logarithm and floating-point number dissection
<code>log10</code>	Common logarithm (base 10)
<code>minus</code>	Subtraction
<code>mod</code>	Remainder after division (modulo operation)

mtimes	Matrix multiplication
ndims	Number of array dimensions
plus	Add numbers, append strings
pow10	Base 10 power and scale half-precision numbers
pow2	Base 2 power and scale floating-point numbers
power	Element-wise power
rdivide	Right array division
real	Real part of complex number
rem	Remainder after division
round	Round to nearest decimal or integer
rsqrt	Reciprocal square root
sqrt	Square root
tanh	Hyperbolic tangent
times	Multiplication
uminus	Unary minus
uplus	Unary plus

Data Types

bin	Unsigned binary representation of stored integer of fi object
double	Double-precision arrays
fi	Construct fixed-point numeric object
int8	8-bit signed integer arrays
int16	16-bit signed integer arrays
int32	32-bit signed integer arrays
int64	64-bit signed integer arrays
isnan	Determine which array elements are NaN
isreal	Determine whether array uses complex storage
single	Single-precision arrays
uint8	8-bit unsigned integer arrays
uint16	16-bit unsigned integer arrays
uint32	32-bit unsigned integer arrays
uint64	64-bit unsigned integer arrays

Relational and Logical Operators

eq	Determine equality
ge	Determine greater than or equal to
gt	Determine greater than
le	Determine less than or equal to
lt	Determine less than
ne	Determine inequality

Array and Matrix Operations

cat	Concatenate arrays
ctranspose	Complex conjugate transpose
horzcat	Horizontal concatenation for heterogeneous arrays
isfinite	Determine which array elements are finite
isinf	Determine which array elements are infinite
norm	Vector and matrix norms
numel	Number of array elements
reshape	Reshape array

size Array size
transpose Transpose vector or matrix
vertcat Vertical concatenation for heterogeneous arrays

Language Fundamentals

disp Display value of variable

Examples

Create a CustomFloat Object

This example shows how to create a CustomFloat object.

```
v = pi;
x = CustomFloat(v)
```

```
x =
    3.1416
```

```

      Data Type: Floating-point: Double-precision
      WordLength: 64
      MantissaLength: 52
      ExponentLength: 11
      ExponentBias: 1023
```

Because the input to the CustomFloat constructor was a double, the data type of the CustomFloat object, x, is also a double. If the value passed in to the CustomFloat function is a single, then the resulting CustomFloat object will also have a single-precision floating-point data type.

```
v = single(pi);
x = CustomFloat(v)
```

```
x =
    3.1416
```

```

      Data Type: Floating-point: Single-precision
      WordLength: 32
      MantissaLength: 23
      ExponentLength: 8
      ExponentBias: 127
```

Create a Half-Precision CustomFloat Object

To create a CustomFloat object with a specified floating-point data type, specify the data type as the second argument in the CustomFloat function.

```
v = pi;
x = CustomFloat(v, 'half')
```

```
x =
    3.1406
```

```
    Data Type: Floating-point: Half-precision
    WordLength: 16
    MantissaLength: 10
    ExponentLength: 5
    ExponentBias: 15
```

Create a CustomFloat Object with Specified Word Length and Mantissa Length

Specify a word length and a mantissa length in the CustomFloat function.

```
v = pi;
wl = 16;
ml = 4;
x = CustomFloat(v,wl,ml)

x =
    3.1250
```

```
    Data Type: Floating-point: Custom-precision
    WordLength: 16
    MantissaLength: 4
    ExponentLength: 11
    ExponentBias: 1023
```

Compare the difference between the double-precision value and the value of the CustomFloat object as you change the mantissa length.

```
err = zeros(1,12);
for ml = 1:12
    x = CustomFloat(v,wl,ml);
    err(ml) = v-double(x);
end

plot(err);
title('Error: v - double(x)');
ylabel('Error');
xlabel('Mantissa Length');
```

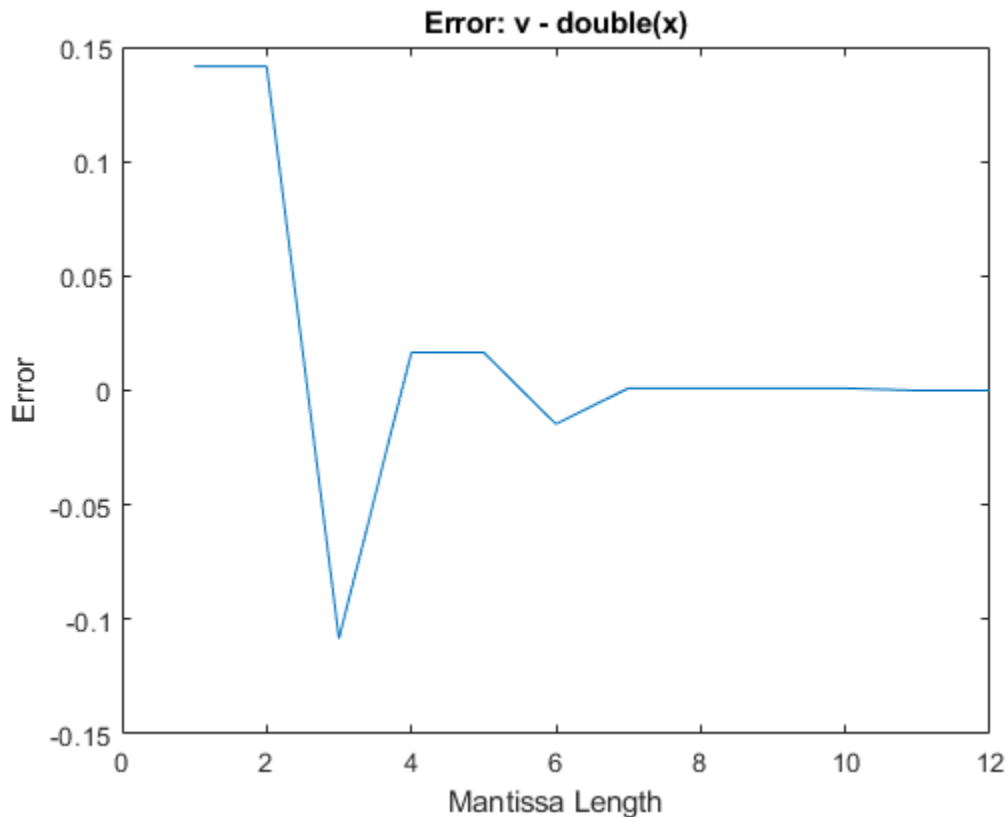

Typecast a Value to a New CustomFloat Data Type

Using the 'typecast' input argument, the CustomFloat function creates a CustomFloat object with the bit pattern of the input value, and the specified word length and mantissa length.

Define a single-precision value. Single-precision floating-point data types have a 32-bit word length and 23-bit mantissa length. View the binary representation of the single-precision value.

```
v = single(pi);
bit_pattern = bin(CustomFloat(v))

bit_pattern =
'01000000010010010000111111011011'
```

Define a CustomFloat object that has the same bit pattern as the input value, but has a different mantissa length.

```
x = CustomFloat(v, 32, 20, 'typecast')

x =
    50.1239
```

```
Data Type: Floating-point: Custom-precision
WordLength: 32
```

```
MantissaLength: 20
ExponentLength: 11
ExponentBias: 1023
```

View the binary representation of the CustomFloat object, and compare it to the bit pattern of the single-precision input value.

```
bit_pattern2 = bin(x)

bit_pattern2 =
'0100000001001001000011111011011'

same = strcmp(bit_pattern, bit_pattern2)

same = logical
      1
```

Limitations

The following functions, which support custom floating-point inputs, do not support complex custom floating-point inputs.

- `ceil`
- `cosh`
- `exp`
- `fix`
- `floor`
- `ge`
- `gt`
- `hypot`
- `le`
- `log`
- `log10`
- `log2`
- `lt`
- `mod`
- `pow10`
- `pow2`
- `power`
- `rem`
- `round`
- `rsqrt`
- `sqrt`
- `tanh`

See Also

double | half | single

Topics

“Floating-Point Numbers”

Introduced in R2020a

DataTypeWorkflow.findDecoupledSubsystems

Get a list of subsystems to replace with an approximation

Syntax

```
systemsToApproximate = DataTypeWorkflow.findDecoupledSubsystems(system)
```

Description

`systemsToApproximate = DataTypeWorkflow.findDecoupledSubsystems(system)` returns a table containing all of the subsystems in the system specified by `system` created by the Fixed-Point Tool during the preparation stage of conversion.

When converting a model to fixed point using the Fixed-Point Tool, when you click **Prepare**, the tool finds any blocks that are not supported for conversion. When the tool finds these blocks, it isolates the block by placing it in a subsystem surrounded by Data Type Conversion blocks. After converting the rest of the system to fixed point, use this function to get a list of all the subsystems you must replace. You can use the Lookup Table Optimizer to generate a lookup table approximation of the subsystems containing the unsupported blocks.

Examples

Replace Unsupported Blocks with a Lookup Table Approximation

In this example, you replace a block that is not supported for fixed-point conversion, with a lookup table approximation.

Open the model.

```
open_system('ex_fixed_point_workflow_lutapprox')
```

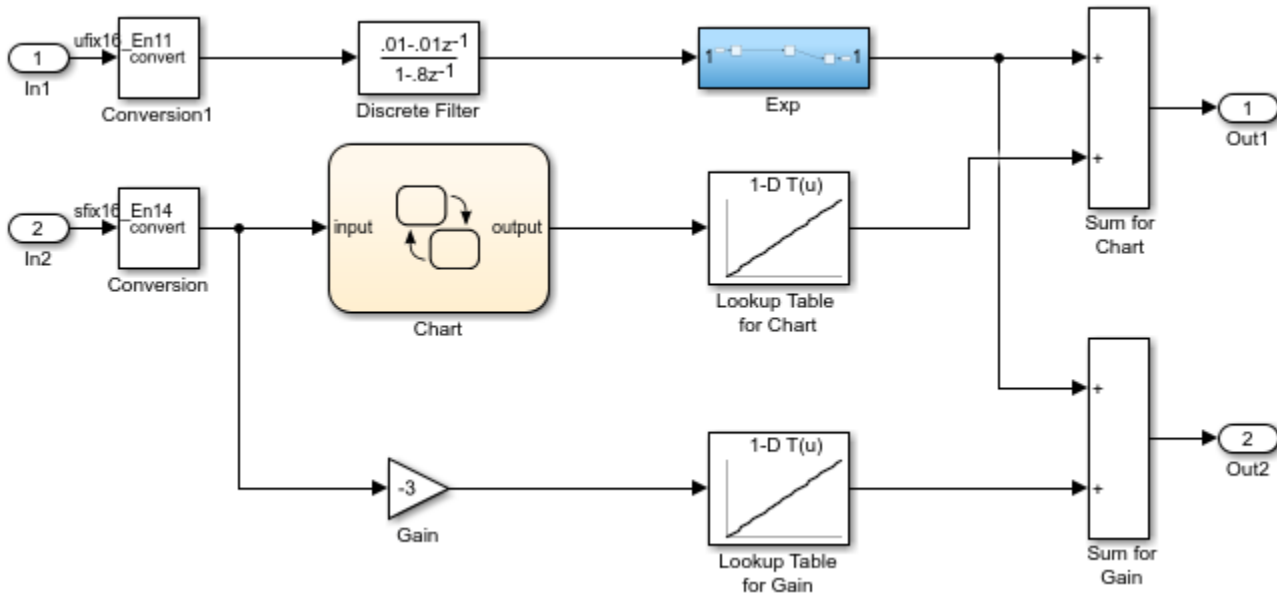
The Controller Subsystem in the model uses fixed-point data types, except in the Exp subsystem. This subsystem was created by the Fixed-Point Tool during the preparation stage of the conversion. In this example, you use the Lookup Table Optimizer to replace this subsystem with a lookup table approximation.

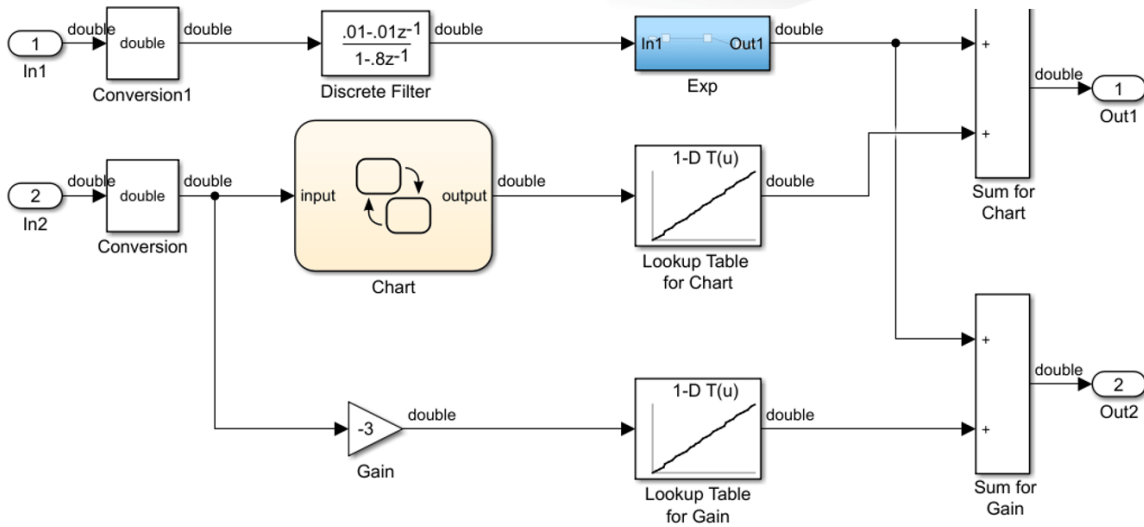
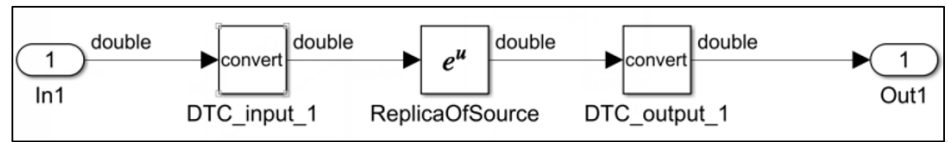

Identify the subsystems that you need to replace using the `DataTypeWorkflow.findDecoupledSubsystems` function.

```
decoupled = DataTypeWorkflow.findDecoupledSubsystems(gcs)
```

decoupled =

1x2 table

ID	BlockPath
1	{'ex_fixed_point_workflow_lutapprox/Controller Subsystem/Exp'}

To replace the functions, open the Lookup Table Optimizer. In the Simulink **Apps** tab, select **Lookup Table Optimizer**.

On the **Objective** page of the Lookup Table Optimizer, select **Simulink Block**. Click **Next**.

Under **Block Information**, copy and paste the path to the decoupled subsystem created by the Fixed-Point Tool.

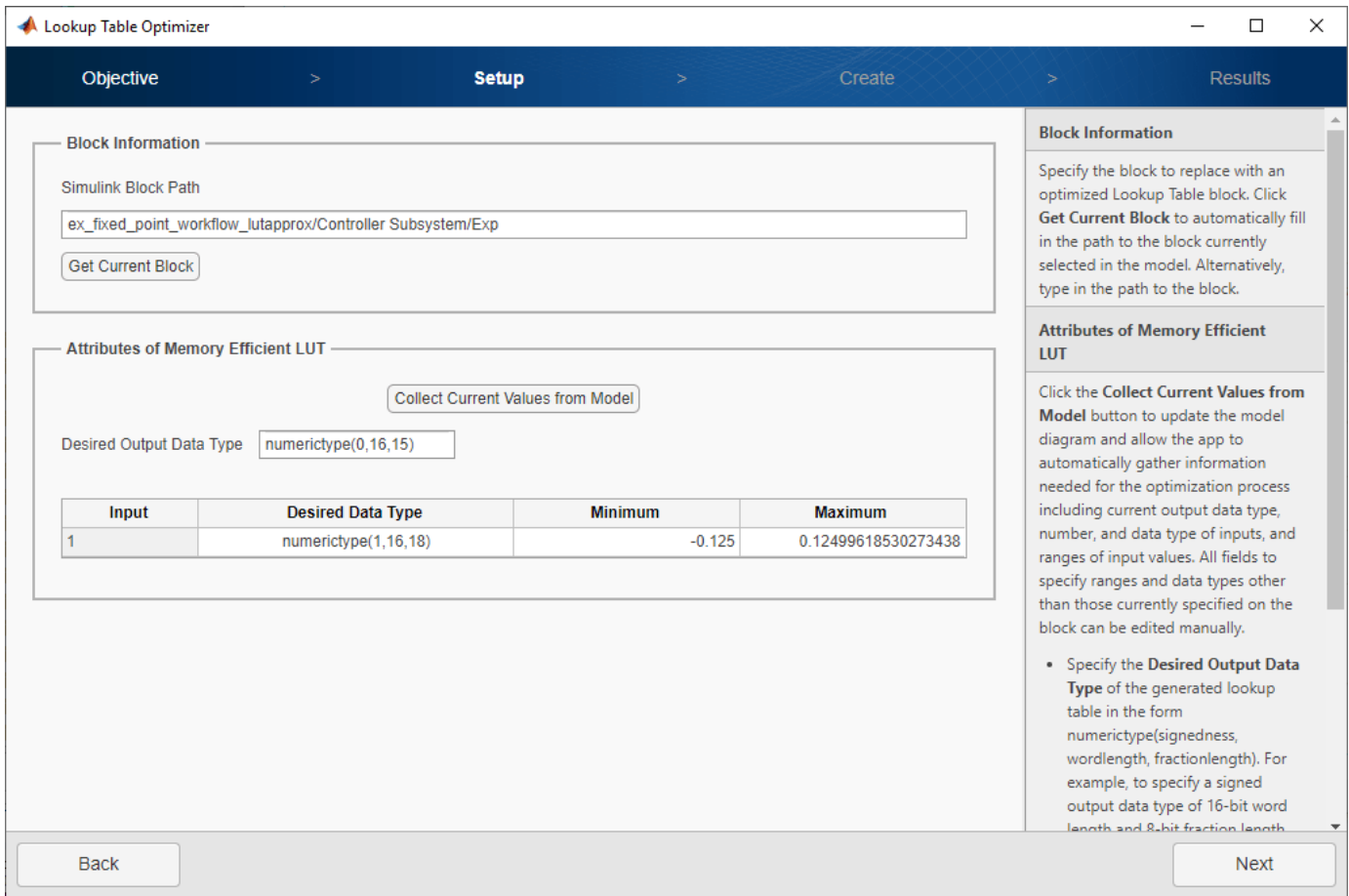

Continue through the steps of the Lookup Table Optimizer to generate the lookup table approximation.

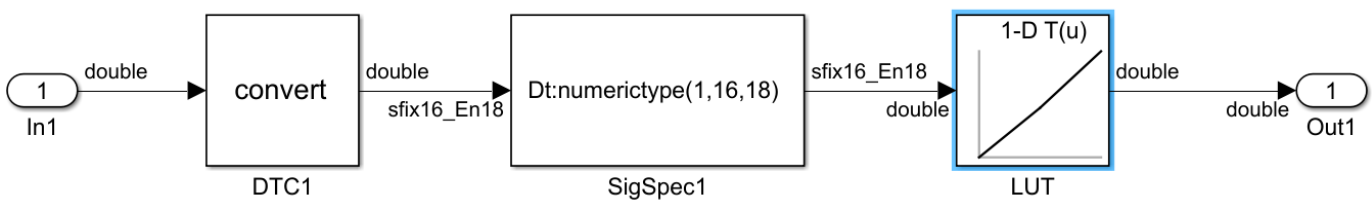

Input Arguments

system — System containing the decoupled subsystems

character vector

System containing the decoupled subsystems, specified as a character vector.

Output Arguments

systemsToApproximate — Subsystems to approximate with a lookup table

table

A list of the subsystems decoupled from the model by the Fixed-Point Tool to approximate, returned as a table.

See Also

`DataTypeWorkflow.Converter` | **Lookup Table Optimizer**

Topics

“Convert Floating-Point Model to Fixed Point”

“Use the Fixed-Point Tool to Prepare a System for Conversion”

Introduced in R2019a

dec

Unsigned decimal representation of stored integer of `fi` object

Syntax

`b = dec(a)`

Description

`b = dec(a)` returns the stored integer of `fi` object `a` in unsigned decimal format as a character vector.

Fixed-point numbers can be represented as

$$\text{real-worldvalue} = 2^{-\text{fractionlength}} \times \text{storedinteger}$$

or, equivalently as

$$\text{real-worldvalue} = (\text{slope} \times \text{storedinteger}) + \text{bias}$$

The stored integer is the raw binary number, in which the binary point is assumed to be at the far right of the word.

Examples

View Stored Integer of `fi` Object in Unsigned Decimal Format

Create a signed `fi` object with values `-1` and `1`, a word length of 8 bits, and a fraction length of 7 bits.

```
a = fi([-1 1], 1, 8, 7)
```

```
a=1x2 object
-1.0000    0.9922
```

```
    DataTypeMode: Fixed-point: binary point scaling
    Signedness: Signed
    WordLength: 8
    FractionLength: 7
```

Find the unsigned decimal representation of the stored integers of `fi` object `a`.

```
b = dec(a)
```

```
b =
'128    127'
```

Input Arguments

a — **fi object to view in unsigned decimal format**

fi object

Input fi object to view in unsigned decimal format.

Data Types: fi

See Also

bin | hex | oct | sdec | storedInteger

Introduced before R2006a

denormalmax

Largest denormalized quantized number for `quantizer` object

Syntax

```
x = denormalmax(q)
```

Description

`x = denormalmax(q)` is the largest positive denormalized quantized number where `q` is a `quantizer` object. Anything larger than `x` is a normalized number. Denormalized numbers apply only to floating-point format. When `q` represents fixed-point numbers, this function returns `eps(q)`.

Examples

```
q = quantizer('float',[6 3]);  
x = denormalmax(q)  
  
x =  
  
    0.1875
```

Algorithms

When `q` is a floating-point `quantizer` object,

```
denormalmax(q) = realmin(q) - denormalmin(q)
```

When `q` is a fixed-point `quantizer` object,

```
denormalmax(q) = eps(q)
```

See Also

`denormalmin` | `eps` | `quantizer`

Introduced before R2006a

denormalmin

Smallest denormalized quantized number for `quantizer` object

Syntax

```
x = denormalmin(q)
```

Description

`x = denormalmin(q)` is the smallest positive denormalized quantized number where `q` is a `quantizer` object. Anything smaller than `x` underflows to zero with respect to the `quantizer` object `q`. Denormalized numbers apply only to floating-point format. When `q` represents a fixed-point number, `denormalmin` returns `eps(q)`.

Examples

```
q = quantizer('float',[6 3]);  
x = denormalmin(q)
```

```
x =
```

```
0.0625
```

Algorithms

When `q` is a floating-point `quantizer` object,

$$x = 2^{E_{min} - f}$$

where E_{min} is equal to `exponentmin(q)`.

When `q` is a fixed-point `quantizer` object,

$$x = \text{eps}(q) = 2^{-f}$$

where f is equal to `fractionlength(q)`.

See Also

`denormalmax` | `eps` | `quantizer`

Introduced before R2006a

divide

Package: embedded

Divide two `fi` objects

Syntax

```
c = divide(T,a,b)
```

Description

`c = divide(T,a,b)` performs division on the elements of `a` by the elements of `b`. The result `c` has the numeric type specified by numeric type object `T`.

Examples

Divide Two `fi` Objects

This example shows how to control the precision of the `divide` function.

Create an unsigned `fi` object with an 80-bit word length and 2^{-83} scaling, which puts the leading 1 of the representation into the most significant bit. Initialize the object with value 0.1, and examine the binary representation.

```
P = fipref('NumberDisplay', 'bin',...
         'NumericTypeDisplay', 'short',...
         'FimathDisplay', 'none');
a = fi(0.1, 0, 80, 83)

a =
110011001100110011001100110011001100110011001100110011001100110011010000000000000000000000000000000
    numerictype(0,80,83)
```

Notice that the infinite repeating representation is truncated after 52 bits, because the mantissa of an IEEE® standard double-precision floating-point number has 52 bits.

Contrast the above to calculating 1/10 in fixed-point arithmetic with the quotient set to the same numeric type as before.

```
T = numerictype('Signed', false,...
               'WordLength', 80,...
               'FractionLength', 83);
a = fi(1);
b = fi(10);
c = divide(T, a, b);
c.bin

ans =
'110011001100110011001100110011001100110011001100110011001100110011001100110011001100110011001101'
```

Notice that when you use the `divide` function, the quotient is calculated to the full 80 bits, regardless of the precision of `a` and `b`. Thus, the `fi` object `c` represents 1/10 more precisely than a IEEE® standard double-precision floating-point number can.

Input Arguments

T — Numeric type of the output

`numericType` object

Numeric type of the output, specified as a `numericType` object.

a — Numerator

scalar | vector | matrix | multidimensional array

Numerator, specified as a scalar, vector, matrix, or multidimensional array.

`a` and `b` must have the same dimensions unless one is a scalar. If either `a` or `b` is scalar, then `c` has the dimensions of the nonscalar object.

Data Types: `single` | `double` | `int8` | `int16` | `int32` | `int64` | `uint8` | `uint16` | `uint32` | `uint64` | `logical` | `fi`

Complex Number Support: Yes

b — Denominator

scalar | vector | matrix | multidimensional array

Denominator, specified as a real scalar, vector, matrix, or multidimensional array.

`a` and `b` must have the same dimensions unless one is a scalar. If either `a` or `b` is scalar, then `c` has the dimensions of the nonscalar object.

Data Types: `single` | `double` | `int8` | `int16` | `int32` | `int64` | `uint8` | `uint16` | `uint32` | `uint64` | `logical` | `fi`

Complex Number Support: Yes

Output Arguments

c — Quotient

scalar | vector | matrix | multidimensional array

Solution, returned as a scalar, vector, matrix, or multidimensional array. When `a` and `b` are the same size, `c` is the same dimensions as `a` and `b`. If either `a` or `b` is scalar, then `c` has the dimensions of the nonscalar object.

Algorithms

If `a` and `b` are both `fi` objects, `c` has the same `fimath` object as `a`. If `c` has a `fi` Fixed data type, and any one of the inputs have `fi` floating point data types, then the `fi` floating point is converted into a fixed-point value. Intermediate quantities are calculated using the `fimath` object of `a`.

If either `a` or `b` is a `fi` object, and the other is a MATLAB built-in numeric type, then the built-in object is cast to the word length of the `fi` object, preserving best-precision fraction length. Intermediate quantities are calculated using the `fimath` object of the input `fi` object.

If *a* and *b* are both MATLAB built-in doubles, then *c* is the floating-point quotient *a./b*, and `numericType T` is ignored.

Data Type Propagation Rules

For syntaxes for which Fixed-Point Designer software uses the `numericType` object *T*, the `divide` function follows the data type propagation rules listed in the following table. In most cases, floating-point data types are propagated. This allows you to write code that can be used with both fixed-point and floating-point inputs.

Data Type of Input <code>fi</code> Objects <i>a</i> and <i>b</i>		Data Type of <code>numericType</code> Object <i>T</i>	Data Type of Output <i>c</i>
Built-in double	Built-in double	Any	Built-in double
<code>fi Fixed</code>	<code>fi Fixed</code>	<code>fi Fixed</code>	Data type of <code>numericType</code> object <i>T</i>
<code>fi Fixed</code>	<code>fi Fixed</code>	<code>fi double</code>	<code>fi double</code>
<code>fi Fixed</code>	<code>fi Fixed</code>	<code>fi single</code>	<code>fi single</code>
<code>fi Fixed</code>	<code>fi Fixed</code>	<code>fi ScaledDouble</code>	<code>fi ScaledDouble</code> with properties of <code>numericType</code> object <i>T</i>
<code>fi double</code>	<code>fi double</code>	<code>fi Fixed</code>	<code>fi double</code>
<code>fi double</code>	<code>fi double</code>	<code>fi double</code>	<code>fi double</code>
<code>fi double</code>	<code>fi double</code>	<code>fi single</code>	<code>fi single</code>
<code>fi double</code>	<code>fi double</code>	<code>fi ScaledDouble</code>	<code>fi double</code>
<code>fi single</code>	<code>fi single</code>	<code>fi Fixed</code>	<code>fi single</code>
<code>fi single</code>	<code>fi single</code>	<code>fi double</code>	<code>fi double</code>
<code>fi single</code>	<code>fi single</code>	<code>fi single</code>	<code>fi single</code>
<code>fi single</code>	<code>fi single</code>	<code>fi ScaledDouble</code>	<code>fi single</code>
<code>fi ScaledDouble</code>	<code>fi ScaledDouble</code>	<code>fi Fixed</code>	If either input <i>a</i> or <i>b</i> is of type <code>fi ScaledDouble</code> , then output <i>c</i> is of type <code>fi ScaledDouble</code> with properties of <code>numericType</code> object <i>T</i> .
<code>fi ScaledDouble</code>	<code>fi ScaledDouble</code>	<code>fi double</code>	<code>fi double</code>
<code>fi ScaledDouble</code>	<code>fi ScaledDouble</code>	<code>fi single</code>	<code>fi single</code>
<code>fi ScaledDouble</code>	<code>fi ScaledDouble</code>	<code>fi ScaledDouble</code>	If either input <i>a</i> or <i>b</i> is of type <code>fi ScaledDouble</code> , then output <i>c</i> is of type <code>fi ScaledDouble</code> with properties of <code>numericType</code> object <i>T</i> .

Extended Capabilities

C/C++ Code Generation

Generate C and C++ code using MATLAB® Coder™.

Usage notes and limitations:

- Any non-`fi` input must be constant; that is, its value must be known at compile time so that it can be cast to a `fi` object.
- Complex and imaginary divisors are not supported.
- Code generation does not support the syntax `T.divide(a,b)`.

HDL Code Generation

Generate Verilog and VHDL code for FPGA and ASIC designs using HDL Coder™.

- For HDL Code generation, the divisor must be a constant and a power of two.
- Non-`fi` inputs must be constant; that is, their values must be known at compile time so that they can be cast to `fi` objects.
- Complex and imaginary divisors are not supported.
- Code generation in MATLAB does not support the syntax `T.divide(a,b)`.

See Also

`add` | `fi` | `fimath` | `mpy` | `mrdivide` | `numericType` | `rdivide` | `sub` | `sum`

Introduced before R2006a

double

Double-precision floating-point real-world value of `fi` object

Syntax

```
b = double(a)
```

Description

`b = double(a)` returns the real-world value of a `fi` object in double-precision floating point format.

Fixed-point numbers can be represented as

$$real\text{-}worldvalue = 2^{-fractionlength} \times storedinteger$$

or, equivalently as

$$real\text{-}worldvalue = (slope \times storedinteger) + bias$$

Examples

View Stored Integer of `fi` Object in Double-Precision Format

Create a signed `fi` object with values -1 and 1, a word length of 8 bits, and a fraction length of 7 bits.

```
a = fi([-1 1], 1, 8, 7)
```

```
a=1x2 object
```

```
-1.0000    0.9922
```

```
      DataTypeMode: Fixed-point: binary point scaling
      Signedness: Signed
      WordLength: 8
      FractionLength: 7
```

Find the double-precision floating-point real-world value of the stored integers of `fi` object `a`.

```
b = double(a)
```

```
b = 1x2
```

```
-1.0000    0.9922
```

Input Arguments

a — `fi` object to view in double-precision floating-point

`fi` object

Input `fi` object to view in double-precision floating-point.

Data Types: `fi`

Extended Capabilities

C/C++ Code Generation

Generate C and C++ code using MATLAB® Coder™.

Usage notes and limitations:

- For the automated workflow, do not use explicit double or single casts in your MATLAB algorithm to insulate functions that do not support fixed-point data types. The automated conversion tool does not support these casts. Instead of using casts, supply a replacement function. For more information, see “Function Replacements”.

See Also

`single`

Introduced before R2006a

eps

Quantized relative accuracy for `fi` or `quantizer` objects

Syntax

```
d = eps(a)
d = eps(q)
```

Description

`d = eps(a)` returns the value of the least significant bit value of the `fi` object `a`. The result of this function is equivalent to that given by the Fixed-Point Designer function `lsb`.

`d = eps(q)` returns the value of the least significant bit of the value of the `quantizer` object `q`.

Examples

Quantized Relative Accuracy of `fi` Object

```
a = fi(pi, 1, 8)
eps(a)

ans =

    0.1250
```

Quantization Level of `quantizer` Object

```
q = quantizer('fixed',[6 3]);
eps(q)

ans =

    0.1250
```

Input Arguments

a — Input `fi` object

`fi` object

Input `fi` object.

Data Types: `fi`

q — Input `quantizer` object

`quantizer` object

Input `quantizer` object.

Extended Capabilities

C/C++ Code Generation

Generate C and C++ code using MATLAB® Coder™.

Usage notes and limitations:

- Code generation supports scalar fixed-point signals only.
- Code generation supports scalar, vector, and matrix, `fi` single and `fi` double signals.

HDL Code Generation

Generate Verilog and VHDL code for FPGA and ASIC designs using HDL Coder™.

- Supported for scalar fixed-point signals only.
- Supported for scalar, vector, and matrix, `fi` single and `fi` double signals.

See Also

`fi` | `intmax` | `intmin` | `lowerbound` | `lsb` | `quantizer` | `range` | `realmax` | `realmin` | `upperbound`

Introduced before R2006a

eq

Determine whether real-world values of two `fi` objects are equal

Syntax

```
c = eq(a,b)
a == b
```

Description

`c = eq(a,b)` is called for the syntax `a == b` when `a` or `b` is a `fi` object. `a` and `b` must have the same dimensions unless one is a scalar. A scalar can be compared with another object of any size.

`a == b` does an element-by-element comparison between `a` and `b` and returns a matrix of the same size with elements set to 1 where the relation is true, and 0 where the relation is false.

In relational operations comparing a floating-point value to a fixed-point value, the floating-point value is cast to the same word length and signedness as the `fi` object, with best-precision scaling.

Examples

Compare Two `fi` Objects

Use the `isequal` function to determine if two `fi` objects have the same real-world value.

```
a = fi(pi);
b = fi(pi, 1, 32);
a == b

ans = logical
     0
```

Input `a` has a 16-bit word length, while input `b` has a 32-bit word length. The `eq` function returns 0 because the two `fi` objects do not have the same real-world value.

Compare a Double to a `fi` Object

When comparing a double to a `fi` object, the double is cast to the same word length and signedness of the `fi` object.

```
a = fi(pi);
b = pi;
a == b

ans = logical
     1
```

The `eq` function casts `b` to the same word length as `a`, and returns 1. This behavior allows relational operations to work between `fi` objects and floating-point constants without introducing floating-point values in generated code.

Extended Capabilities

C/C++ Code Generation

Generate C and C++ code using MATLAB® Coder™.

Usage notes and limitations:

- Fixed-point signals with different biases are not supported.

HDL Code Generation

Generate Verilog and VHDL code for FPGA and ASIC designs using HDL Coder™.

See Also

`ge` | `gt` | `isequal` | `le` | `lt` | `ne`

Introduced before R2006a

errmean

Mean of quantization error

Syntax

```
m = errmean(q)
```

Description

`m = errmean(q)` returns the mean of a uniformly distributed random quantization error that arises from quantizing a signal by quantizer object `q`.

Note The results are not exact when the signal precision is close to the precision of the quantizer.

Examples

Find `m`, the mean of the quantization error for quantizer `q`:

```
q = quantizer;  
m = errmean(q)  
  
m =  
  
-1.525878906250000e-05
```

Now compare `m` to `m_est`, the sample mean from a Monte Carlo experiment:

```
r = realmax(q);  
u = 2*r*rand(1000,1)-r; % Original signal  
y = quantize(q,u); % Quantized signal  
e = y - u; % Error  
m_est = mean(e) % Estimate of the error mean  
  
m_est =  
  
-1.526738835715480e-05
```

See Also

[errpdf](#) | [errvar](#) | [quantize](#)

Introduced in R2008a

errpdf

Probability density function of quantization error

Syntax

```
[f,x] = errpdf(q)  
f = errpdf(q,x)
```

Description

`[f,x] = errpdf(q)` returns the probability density function `f` evaluated at the values in `x`. The vector `x` contains the uniformly distributed random quantization errors that arise from quantizing a signal by quantizer object `q`.

`f = errpdf(q,x)` returns the probability density function `f` evaluated at the values in vector `x`.

Note The results are not exact when the signal precision is close to the precision of the quantizer.

Examples

Compute the PDF of the quantization error

```
q = quantizer('nearest',[4 3]);  
[f,x] = errpdf(q);  
subplot(211)  
plot(x,f)  
title('Computed PDF of the quantization error.')
```

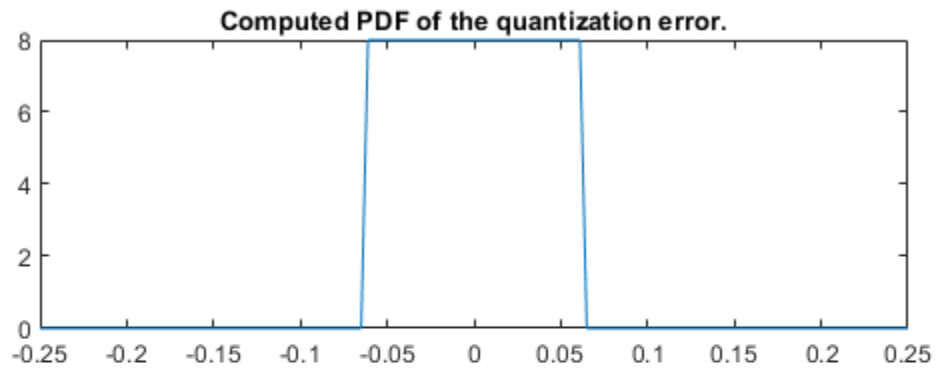

The output plot shows the probability density function of the quantization error. Compare this result to a plot of the sample probability density function from a Monte Carlo experiment:

```
r = realmax(q);  
u = 2*r*rand(10000,1)-r; % Original signal  
y = quantize(q,u);      % Quantized signal  
e = y - u;              % Error  
subplot(212)  
hist(e,20)  
gca.xlim = [min(x) max(x)];  
title('Estimate of the PDF of the quantization error.')
```

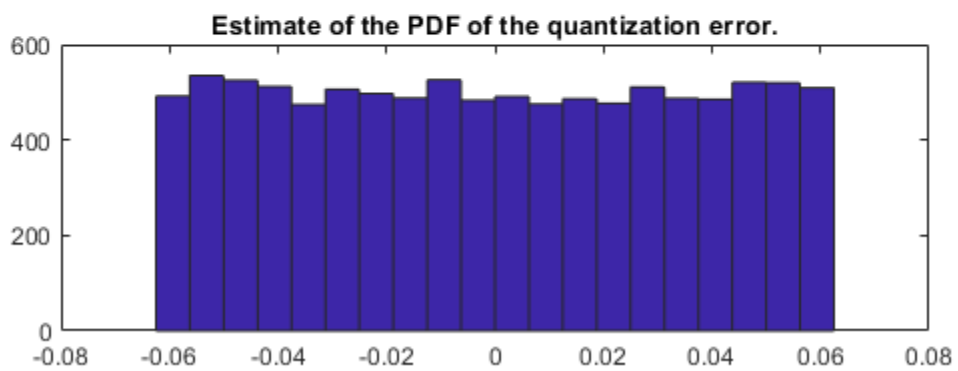
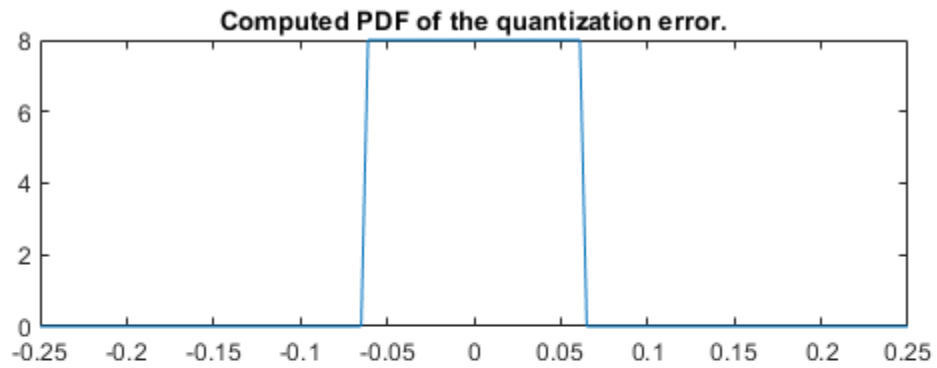

See Also

`errmean` | `errvar` | `quantize`

Introduced in R2008a

errvar

Variance of quantization error

Syntax

```
v = errvar(q)
```

Description

`v = errvar(q)` returns the variance of a uniformly distributed random quantization error that arises from quantizing a signal by quantizer object `q`.

Note The results are not exact when the signal precision is close to the precision of the quantizer.

Examples

Find `v`, the variance of the quantization error for quantizer object `q`:

```
q = quantizer;  
v = errvar(q)
```

```
v =
```

```
7.761021455128987e-11
```

Now compare `v` to `v_est`, the sample variance from a Monte Carlo experiment:

```
r = realmax(q);  
u = 2*r*rand(1000,1)-r; % Original signal  
y = quantize(q,u); % Quantized signal  
e = y - u; % Error  
v_est = var(e) % Estimate of the error variance
```

```
v_est =
```

```
7.686538499583834e-11
```

See Also

[errmean](#) | [errpdf](#) | [quantize](#)

Introduced in R2008a

exponentbias

Exponent bias for quantizer object

Syntax

```
b = exponentbias(q)
```

Description

`b = exponentbias(q)` returns the exponent bias of the quantizer object `q`. For fixed-point quantizer objects, `exponentbias(q)` returns 0.

Examples

```
q = quantizer('double');  
b = exponentbias(q)
```

```
b =
```

```
1023
```

Algorithms

For floating-point quantizer objects,

$$b = 2^{e-1} - 1$$

where $e = \text{eps}(q)$, and `exponentbias` is the same as the exponent maximum.

For fixed-point quantizer objects, $b = 0$ by definition.

See Also

`eps` | `exponentlength` | `exponentmax` | `exponentmin`

Introduced before R2006a

exponentlength

Exponent length of quantizer object

Syntax

```
e = exponentlength(q)
```

Description

`e = exponentlength(q)` returns the exponent length of quantizer object `q`. When `q` is a fixed-point quantizer object, `exponentlength(q)` returns 0. This is useful because exponent length is valid whether the quantizer object mode is floating point or fixed point.

Examples

```
q = quantizer('double');  
e = exponentlength(q)
```

```
e =
```

```
    11
```

Algorithms

The exponent length is part of the format of a floating-point quantizer object `[w e]`. For fixed-point quantizer objects, $e = 0$ by definition.

See Also

`eps` | `exponentbias` | `exponentmax` | `exponentmin`

Introduced before R2006a

exponentmax

Maximum exponent for quantizer object

Syntax

```
exponentmax(q)
```

Description

`exponentmax(q)` returns the maximum exponent for quantizer object `q`. When `q` is a fixed-point quantizer object, it returns 0.

Examples

```
q = quantizer('double');  
exponentmax(q)
```

```
ans =
```

```
1023
```

Algorithms

For floating-point quantizer objects,

$$E_{max} = 2^{e-1} - 1$$

For fixed-point quantizer objects, $E_{max} = 0$ by definition.

See Also

`eps` | `exponentbias` | `exponentlength` | `exponentmin`

Introduced before R2006a

exponentmin

Minimum exponent for quantizer object

Syntax

```
emin = exponentmin(q)
```

Description

`emin = exponentmin(q)` returns the minimum exponent for quantizer object `q`. If `q` is a fixed-point quantizer object, `exponentmin` returns 0.

Examples

```
q = quantizer('double');  
emin = exponentmin(q)
```

```
emin =  
-1022
```

Algorithms

For floating-point quantizer objects,

$$E_{min} = -2^{e-1} + 2$$

For fixed-point quantizer objects, $E_{min} = 0$.

See Also

`eps` | `exponentbias` | `exponentlength` | `exponentmax`

Introduced before R2006a

eye

Create identity matrix with fixed-point properties

Syntax

```
I = eye('like',p)
I = eye(n,'like',p)
I = eye(n,m,'like',p)
I = eye(sz,'like',p)
```

Description

`I = eye('like',p)` returns the scalar 1 with the same fixed-point properties and complexity (real or complex) as the prototype argument, `p`. The output, `I`, contains the same `numericType` and `fimath` properties as `p`.

`I = eye(n,'like',p)` returns an `n`-by-`n` identity matrix like `p`, with ones on the main diagonal and zeros elsewhere.

`I = eye(n,m,'like',p)` returns an `n`-by-`m` identity matrix like `p`.

`I = eye(sz,'like',p)` returns an array like `p`, where the size vector, `sz`, defines `size(I)`.

Examples

Create Identity Matrix with Fixed-Point Properties

Create a prototype `fi` object, `p`.

```
p = fi([],1,16,14);
```

Create a 3-by-4 identity matrix with the same fixed-point properties as `p`.

```
I = eye(3,4,'like',p)
```

```
I=3×4 object
```

```
    1     0     0     0
    0     1     0     0
    0     0     1     0
```

```
    DataTypeMode: Fixed-point: binary point scaling
    Signedness: Signed
    WordLength: 16
    FractionLength: 14
```

Create Identity Matrix with Attached fimath

Create a signed `fi` object with word length of 16, fraction length of 15 and `OverflowAction` set to `Wrap`.

```
format long
p = fi([],1,16,15,'OverflowAction','Wrap');
```

Create a 2-by-2 identity matrix with the same `numericType` properties as `p`.

```
X = eye(2,'like',p)
```

```
X=2x2 object
    0.999969482421875          0
           0    0.999969482421875

    DataTypeMode: Fixed-point: binary point scaling
    Signedness: Signed
    WordLength: 16
    FractionLength: 15

    RoundingMethod: Nearest
    OverflowAction: Wrap
    ProductMode: FullPrecision
    SumMode: FullPrecision
```

1 cannot be represented by the data type of `p`, so the value saturates. The output `fi` object `X` has the same `numericType` and `fimath` properties as `p`.

Input Arguments

n — Size of first dimension of **I**

integer value

Size of first dimension of **I**, specified as an integer value.

- If `n` is the only integer input argument, then **I** is a square `n`-by-`n` identity matrix.
- If `n` is 0, then **I** is an empty matrix.
- If `n` is negative, then it is treated as 0.

Data Types: `single` | `double` | `int8` | `int16` | `int32` | `int64` | `uint8` | `uint16` | `uint32` | `uint64`

m — Size of second dimension of **I**

integer value

Size of second dimension of **I**, specified as an integer value.

- If `m` is 0, then **I** is an empty matrix.
- If `m` is negative, then it is treated as 0.

Data Types: `single` | `double` | `int8` | `int16` | `int32` | `int64` | `uint8` | `uint16` | `uint32` | `uint64`

sz — Size of **I**

row vector of no more than two integer values

Size of **I**, specified as a row vector of no more than two integer values.

- If an element of **sz** is 0, then **I** is an empty matrix.
- If an element of **sz** is negative, then the element is treated as 0.

Data Types: single | double | int8 | int16 | int32 | int64 | uint8 | uint16 | uint32 | uint64

p — Prototype

fi object | numeric variable

Prototype, specified as a **fi** object or numeric variable.

If the value 1 overflows the numeric type of **p**, the output saturates regardless of the specified **OverflowAction** property of the attached **fimath**. All subsequent operations performed on the output obey the rules of the attached **fimath**.

Data Types: fi | single | double | int8 | int16 | int32 | int64 | uint8 | uint16 | uint32 | uint64

Tips

Using the `b = cast(a, 'like', p)` syntax to specify data types separately from algorithm code allows you to:

- Reuse your algorithm code with different data types.
- Keep your algorithm uncluttered with data type specifications and switch statements for different data types.
- Improve readability of your algorithm code.
- Switch between fixed-point and floating-point data types to compare baselines.
- Switch between variations of fixed-point settings without changing the algorithm code.

See Also

ones | zeros

Topics

“Implement FIR Filter Algorithm for Floating-Point and Fixed-Point Types using cast and zeros”
“Manual Fixed-Point Conversion Best Practices”

Introduced in R2015a

fi

Construct fixed-point numeric object

Description

To assign a fixed-point data type to a number or variable, create a `fi` object using the `fi` constructor. You can specify numeric attributes and math rules in the constructor or using the `numericType` and `fimath` objects.

Creation

Syntax

```
a = fi
a = fi(v)
a = fi(v,s)
a = fi(v,s,w)
a = fi(v,s,w,f)
a = fi(v,s, w,slope,bias)
a = fi(v,s, w,slopeadjustmentfactor, fixedexponent, bias)
a = fi(v,T)
a = fi( ___, F)
a = fi( ___, Name, Value)
```

Description

`a = fi` returns a `fi` object with no value, 16-bit word length, and 15-bit fraction length.

`a = fi(v)` returns a fixed-point object with value `v` and default property values.

`a = fi(v,s)` returns a fixed-point object with signedness (signed or unsigned) `s`.

`a = fi(v,s,w)` creates a fixed-point object with word length specified by `w`.

`a = fi(v,s,w,f)` creates a fixed-point object with fraction length specified by `f`.

`a = fi(v,s, w,slope,bias)` creates a fixed-point object using slope and bias scaling.

`a = fi(v,s, w,slopeadjustmentfactor, fixedexponent, bias)` creates a fixed-point object using slope and bias scaling.

`a = fi(v,T)` creates a fixed-point object with value `v`, and numeric type properties, `T`.

`a = fi(___, F)` creates a fixed-point object with math settings specified by `fimath` object `F`.

`a = fi(___, Name, Value)` creates a fixed-point object with property values specified by one or more `Name, Value` pair arguments. `Name` must appear inside single quotes (' '). You can specify several name-value pair arguments in any order as `Name1, Value1, . . . , NameN, ValueN`.

Input Arguments

v – Value

scalar | vector | matrix | multi-dimensional array

Value of the `fi` object, specified as a scalar, vector, matrix, or multidimensional array.

The value of the output `fi` object is the value of the input quantized to the data type specified in the `fi` constructor.

You can specify the non-finite values `-Inf`, `Inf`, and `NaN` as the value only if you fully specify the numeric type of the `fi` object. When `fi` is specified as a fixed-point numeric type,

- `NaN` maps to `0`.
- When the `'OverflowAction'` property of the `fi` object is set to `'Wrap'`, `-Inf`, and `Inf` map to `0`.
- When the `'OverflowAction'` property of the `fi` object is set to `'Saturate'`, `Inf` maps to the largest representable value, and `-Inf` maps to the smallest representable value.

Data Types: `single` | `double` | `int8` | `int16` | `int32` | `int64` | `uint8` | `uint16` | `uint32` | `uint64` | `logical` | `fi`

s – Signedness

1 (default) | 0

Signedness of the `fi` object, specified as a boolean. A value of `1`, or `true`, indicates a signed data type. A value of `0`, or `false`, indicates an unsigned data type.

Data Types: `logical`

w – Word length

16 (default) | scalar integer

Word length, in bits, of the `fi` object, specified as a scalar integer.

The `fi` object has a word length limit of 65535 bits.

Data Types: `single` | `double` | `int8` | `int16` | `int32` | `int64` | `uint8` | `uint16` | `uint32` | `uint64` | `logical`

f – Fraction length

15 (default) | scalar integer

Fraction length, in bits, of the `fi` object, specified as a scalar integer. If you do not specify a fraction length, the `fi` object automatically uses the fraction length that gives the best precision while avoiding overflow for the specified value, word length, and signedness.

Data Types: `single` | `double` | `int8` | `int16` | `int32` | `int64` | `uint8` | `uint16` | `uint32` | `uint64` | `logical`

slope – Slope

scalar integer

Slope of the scaling, specified as a scalar integer. The following equation represents the real-world value of a slope bias scaled number.

$$real - worldvalue = (slope \times integer) + bias$$

Data Types: single | double | int8 | int16 | int32 | int64 | uint8 | uint16 | uint32 | uint64 | logical

bias — Bias

scalar

Bias of the scaling, specified as a scalar. The following equation represents the real-world value of a slope bias scaled number.

$$real - worldvalue = (slope \times integer) + bias$$

Data Types: single | double | int8 | int16 | int32 | int64 | uint8 | uint16 | uint32 | uint64 | logical

slopeadjustmentfactor — Slope adjustment factor

scalar integer

The slope adjustment factor of a slope bias scaled number. The following equation demonstrates the relationship between the slope, fixed exponent, and slope adjustment factor.

$$slope = slopeadjustmentfactor \times 2^{fixedexponent}$$

Data Types: single | double | int8 | int16 | int32 | int64 | uint8 | uint16 | uint32 | uint64 | logical

fixedexponent — Fixed exponent

scalar integer

The fixed exponent of a slope bias scaled number. The following equation demonstrates the relationship between the slope, fixed exponent, and slope adjustment factor.

$$slope = slopeadjustmentfactor \times 2^{fixedexponent}$$

Data Types: single | double | int8 | int16 | int32 | int64 | uint8 | uint16 | uint32 | uint64 | logical

T — Numeric type properties

numeric type object

Numeric type properties of the `fi` object, specified as a `numeric type` object. For more information, see `numeric type`.

F — Fixed-point math properties

`fi math` object

Fixed-point math properties of the `fi` object, specified as a `fi math` object. For more information, see `fi math`.

Properties

“fi Object Properties”

Examples

Create a `fi` object

Create a signed `fi` object with a value of `pi`, a word length of eight bits, and a fraction length of 3 bits.

```
a = fi(pi,1,8,3)
```

```
a =  
    3.1250
```

```
        DataTypeMode: Fixed-point: binary point scaling  
        Signedness: Signed  
        WordLength: 8  
        FractionLength: 3
```

Create an Array of `fi` Objects

Create an array of `fi` objects with 16-bit word length and 12-bit fraction length.

```
a = fi((magic(3)/10), 1, 16, 12)
```

```
a=3x3 object  
    0.8000    0.1001    0.6001  
    0.3000    0.5000    0.7000  
    0.3999    0.8999    0.2000
```

```
        DataTypeMode: Fixed-point: binary point scaling  
        Signedness: Signed  
        WordLength: 16  
        FractionLength: 12
```

Create a `fi` object with Default Word Length and Fraction Length

When you specify only the value and the signedness of the `fi` object, the word length defaults to 16 bits, and the fraction length is set to achieve the best precision possible without overflow.

```
a = fi(pi, 1)
```

```
a =  
    3.1416
```

```
        DataTypeMode: Fixed-point: binary point scaling  
        Signedness: Signed  
        WordLength: 16  
        FractionLength: 13
```

Create a fi Object with Default Precision

If you do not specify a fraction length, input argument `f`, the fraction length of the `fi` object defaults to the fraction length that offers the best precision.

```
a = fi(pi,1,8)
```

```
a =
    3.1563
```

```
    DataTypeMode: Fixed-point: binary point scaling
    Signedness: Signed
    WordLength: 8
    FractionLength: 5
```

The fraction length of `fi` object `a` is five because three bits are required to represent the integer portion of the value when the data type is signed. If the `fi` object uses an unsigned data type, only two bits are needed to represent the integer portion, leaving six fractional bits.

```
b = fi(pi,0,8)
```

```
b =
    3.1406
```

```
    DataTypeMode: Fixed-point: binary point scaling
    Signedness: Unsigned
    WordLength: 8
    FractionLength: 6
```

Create a fi Object with Slope and Bias Scaling

The real-world value of a slope bias scaled number is represented by:

$$\text{real world value} = (\text{slope} \times \text{integer}) + \text{bias}$$

To create a `fi` object that uses slope and bias scaling, include the `slope` and `bias` arguments after the word length in the constructor.

```
a = fi(pi, 1, 16, 3, 2)
```

```
a =
    2
```

```
    DataTypeMode: Fixed-point: slope and bias scaling
    Signedness: Signed
    WordLength: 16
    Slope: 3
    Bias: 2
```

The `DataTypeMode` property of the `fi` object, `a`, is `slope and bias scaling`.

Create a `fi` Object From a Non-Double Value

When the value input argument, `v`, of a `fi` object is a non-double, and you do not specify the word length or fraction length properties, the resulting `fi` object retains the numeric type of the input, `v`.

Create a `fi` object from a built-in integer

When the input is a built-in integer, the fixed-point attributes match the attributes of the integer type.

```
v1 = uint32(5);
a1 = fi(v1)

a1 =
    5

        DataTypeMode: Fixed-point: binary point scaling
        Signedness: Unsigned
        WordLength: 32
        FractionLength: 0

v2 = int8(5);
a2 = fi(v2)

a2 =
    5

        DataTypeMode: Fixed-point: binary point scaling
        Signedness: Signed
        WordLength: 8
        FractionLength: 0
```

Create a `fi` object from a `fi` object

When the input value is a `fi` object, the output uses the same word length, fraction length, and signedness of the input `fi` object.

```
v = fi(pi, 1, 24, 12);
a = fi(v)

a =
    3.1416

        DataTypeMode: Fixed-point: binary point scaling
        Signedness: Signed
        WordLength: 24
        FractionLength: 12
```

Create a `fi` object from a logical

When the input `v` is logical, the `DataTypeMode` property of the output `fi` object is `Boolean`.

```
v = true;
a = fi(v)

a =
    1

        DataTypeMode: Boolean
```

Create a fi object from a single

When the input is single, the `DataTypeMode` property of the output is `Single`.

```
v = single(pi);
a = fi(v)

a =
    3.1416

    DataTypeMode: Single
```

Create a fi Object With an Associated fimath Object

The arithmetic attributes of a `fi` object are defined by a `fimath` object which is attached to that `fi` object.

Create a `fimath` object and specify the `OverflowAction`, `RoundingMethod`, and `ProductMode` properties.

```
F = fimath('OverflowAction', 'Wrap', 'RoundingMethod','Floor', 'ProductMode','KeepMSB')
F =
    RoundingMethod: Floor
    OverflowAction: Wrap
    ProductMode: KeepMSB
    ProductWordLength: 32
    SumMode: FullPrecision
```

Create a `fi` object and specify the `fimath` object, `F`, in the constructor.

```
a = fi(pi, F)

a =
    3.1415

    DataTypeMode: Fixed-point: binary point scaling
    Signedness: Signed
    WordLength: 16
    FractionLength: 13

    RoundingMethod: Floor
    OverflowAction: Wrap
    ProductMode: KeepMSB
    ProductWordLength: 32
    SumMode: FullPrecision
```

Use the `removefimath` function to remove the associated `fimath` object and restore the math settings to their default values.

```
a = removefimath(a)

a =
    3.1415

    DataTypeMode: Fixed-point: binary point scaling
    Signedness: Signed
```

```
WordLength: 16
FractionLength: 13
```

Create a `fi` Object From a `numericType` Object

A `numericType` object contains all of the data type information of a `fi` object. By transitivity, `numericType` properties are also properties of `fi` objects.

You can create a `fi` object that uses all of the properties of an existing `numericType` object by specifying the `numericType` object in the `fi` constructor.

```
T = numericType(0,24,16)
```

```
T =
```

```
DataTypeMode: Fixed-point: binary point scaling
Signedness: Unsigned
WordLength: 24
FractionLength: 16
```

```
a = fi(pi, T)
```

```
a =
    3.1416
```

```
DataTypeMode: Fixed-point: binary point scaling
Signedness: Unsigned
WordLength: 24
FractionLength: 16
```

Create a `fi` Object With Fraction Length Greater Than Word Length

When you use binary-point representation for a fixed-point number, the fraction length can be greater than the word length. In this case, there are implicit leading zeros (for positive numbers) or ones (for negative numbers) between the binary point and the first significant binary digit.

Consider a signed value with a word length of 8, fraction length of 10, and a stored integer value of 5. Calculate the real-world value using the following equation.

$$\text{real world value} = \text{stored integer} \times 2^{-\text{fraction length}}$$

```
realWorldValue = 5*2^(-10)
```

```
realWorldValue = 0.0049
```

Create a signed `fi` object with value `realWorldValue`, a word length of 8 bits, and a fraction length of 10 bits.

```
a = fi(realWorldValue, 1, 8, 10)
```

```
a =
    0.0049
```

```

        DataTypeMode: Fixed-point: binary point scaling
        Signedness: Signed
        WordLength: 8
        FractionLength: 10

```

Get the stored integer value of `a` using the `int` function.

```

int(a)

ans = int8
     5

```

Use the `bin` function to view the stored integer value in binary.

```

bin(a)

ans =
'00000101'

```

Because the fraction length is two bits longer than the word length, the binary value of the stored integer is `X.XX00000101`, where `X` is a placeholder for implicit zeroes. `0.000000101` (binary) is equivalent to `0.0049` (decimal).

Create a `fi` Object With Negative Fraction Length

When you use binary-point representation for a fixed-point number, the fraction length can be negative. In this case, there are implicit trailing zeros (for positive numbers) or ones (for negative numbers) between the binary point and the first significant binary digit.

Consider a signed data type with a word length of 8, fraction length of -2 and a stored integer value of 5. Calculate the stored integer value using the following equation.

$$\text{real world value} = \text{stored integer} \times 2^{-\text{fraction length}}$$

```
realWorldValue = 5*2^(2)
```

```
realWorldValue = 20
```

Create a signed `fi` object with value `realWorldValue`, a word length of 8 bits, and a fraction length of -2 bits.

```
a = fi(realWorldValue, 1, 8, -2)
```

```
a =
     20

```

```

        DataTypeMode: Fixed-point: binary point scaling
        Signedness: Signed
        WordLength: 8
        FractionLength: -2

```

Get the stored integer value of `a` using the `int` function.

```
int(a)
```

```
ans = int8
      5
```

Get the binary value of `a` using the `bin` function.

```
bin(a)

ans =
'00000101'
```

Because the fraction length is negative, the binary value of the stored integer is `00000101XX`, where `X` is a placeholder for implicit zeros. `0000010100` (binary) is equivalent to `20` (decimal).

Create a `fi` Object Specifying Rounding and Overflow Modes

You can set math properties, such as rounding and overflow modes during the creation of the `fi` object.

```
a = fi(pi, 'RoundingMethod', 'Floor', 'OverflowAction', 'Wrap')

a =
    3.1415
```

```
      DataTypeMode: Fixed-point: binary point scaling
      Signedness: Signed
      WordLength: 16
      FractionLength: 13

      RoundingMethod: Floor
      OverflowAction: Wrap
      ProductMode: FullPrecision
      SumMode: FullPrecision
```

The `RoundingMethod` and `OverflowAction` properties are properties of the `fimath` object. Specifying these properties in the `fi` constructor associates a local `fimath` object with the `fi` object.

Use the `removefimath` function to remove the local `fimath` and set the math properties back to their default values.

```
a = removefimath(a)

a =
    3.1415

      DataTypeMode: Fixed-point: binary point scaling
      Signedness: Signed
      WordLength: 16
      FractionLength: 13
```

Use `fi` as an Indexing Argument

When using a `fi` object as an index, the value of the `fi` object must be an integer.

Set up an array to index into.

```
x = 10:-1:1;
```

Create an integer valued `fi` object and use it to index into `x`.

```
a = fi(3);
y = x(a)
```

```
y = 8
```

Use `fi` as the index in a for loop

Create `fi` objects to use as the index of a for loop. The values of the indices must be integers.

```
a = fi(1, 0, 8, 0);
b = fi(2, 0, 8, 0);
c = fi(10, 0, 8, 0);
```

```
for x = a:b:c
    x
end
```

```
x =
```

```
1
```

```
    DataTypeMode: Fixed-point: binary point scaling
    Signedness:   Unsigned
    WordLength:   8
    FractionLength: 0
```

```
x =
```

```
3
```

```
    DataTypeMode: Fixed-point: binary point scaling
    Signedness:   Unsigned
    WordLength:   8
    FractionLength: 0
```

```
x =
```

```
5
```

```
    DataTypeMode: Fixed-point: binary point scaling
    Signedness:   Unsigned
    WordLength:   8
    FractionLength: 0
```

```
x =
```

```
7
```

```
    DataTypeMode: Fixed-point: binary point scaling
    Signedness:   Unsigned
    WordLength:   8
    FractionLength: 0
```

```
x =
```

```
9
```

```
    DataTypeMode: Fixed-point: binary point scaling
```

```
Signedness: Unsigned
WordLength: 8
FractionLength: 0
```

Set Data Type Override on a fi Object

The `fioref` object defines the display and logging attributes for all `fi` objects. Use the `DataTypeOverride` setting of the `fioref` object to override `fi` objects with doubles, singles, or scaled doubles.

Save the current `fioref` settings to restore later.

```
fp = fioref;
initialDT0 = fp.DataTypeOverride;
```

Create a `fi` object with the default settings and original `fioref` settings.

```
a = fi(pi)
a =
    3.1416

    DataTypeMode: Fixed-point: binary point scaling
    Signedness: Signed
    WordLength: 16
    FractionLength: 13
```

Turn on data type override to doubles and create a new `fi` object without specifying its `DataTypeOverride` property so that it uses the data type override settings specified using `fioref`.

```
fioref('DataTypeOverride', 'TrueDoubles')
ans =
    NumberDisplay: 'RealWorldValue'
    NumericTypeDisplay: 'full'
    FimathDisplay: 'full'
    LoggingMode: 'Off'
    DataTypeOverride: 'TrueDoubles'
    DataTypeOverrideAppliesTo: 'AllNumericTypes'
```

```
a = fi(pi)
a =
    3.1416

    DataTypeMode: Double
```

Now create a `fi` object and set its `DataTypeOverride` setting to off so that it ignores the data type override settings of the `fioref` object.

```
b = fi(pi, 'DataTypeOverride', 'Off')
b =
    3.1416

    DataTypeMode: Fixed-point: binary point scaling
```

```

Signedness: Signed
WordLength: 16
FractionLength: 13

```

Restore the `fpref` settings saved at the start of the example.

```
fp.DataTypeOverride = initialDT0;
```

fi Behavior for -Inf, Inf, and NaN

To use the non-numeric values `-Inf`, `Inf`, and `NaN` as fixed-point values with `fi`, you must fully specify the numeric type of the fixed-point object. Automatic best-precision scaling is not supported for these values.

Saturate on Overflow

When the numeric type of the `fi` object is specified to saturate on overflow, then `Inf` maps to the largest representable value of the specified numeric type, and `-Inf` maps to the smallest representable value. `NaN` maps to zero.

```

x = [-inf nan inf];
a = fi(x,1,8,0,'OverflowAction','Saturate')
b = fi(x,0,8,0,'OverflowAction','Saturate')

```

a =

```
-128    0   127
```

```

DataTypeMode: Fixed-point: binary point scaling
Signedness: Signed
WordLength: 8
FractionLength: 0

```

```

RoundingMethod: Nearest
OverflowAction: Saturate
ProductMode: FullPrecision
SumMode: FullPrecision

```

b =

```
0    0   255
```

```

DataTypeMode: Fixed-point: binary point scaling
Signedness: Unsigned
WordLength: 8
FractionLength: 0

```

```

RoundingMethod: Nearest
OverflowAction: Saturate
ProductMode: FullPrecision
SumMode: FullPrecision

```

Wrap on Overflow

When the numeric type of the `fi` object is specified to wrap on overflow, then `-Inf`, `Inf`, and `NaN` map to zero.

```
x = [-inf nan inf];
a = fi(x,1,8,0,'OverflowAction','Wrap')
b = fi(x,0,8,0,'OverflowAction','Wrap')
```

a =

```
    0    0    0

    DataTypeMode: Fixed-point: binary point scaling
    Signedness: Signed
    WordLength: 8
    FractionLength: 0

    RoundingMethod: Nearest
    OverflowAction: Wrap
    ProductMode: FullPrecision
    SumMode: FullPrecision
```

b =

```
    0    0    0

    DataTypeMode: Fixed-point: binary point scaling
    Signedness: Unsigned
    WordLength: 8
    FractionLength: 0

    RoundingMethod: Nearest
    OverflowAction: Wrap
    ProductMode: FullPrecision
    SumMode: FullPrecision
```

Compatibility Considerations

Change in default behavior of `fi` for `-Inf`, `Inf`, and `NaN`

Behavior changed in R2020b

In previous releases, `fi` would return an error when passed the non-finite input values `-Inf`, `Inf`, or `NaN`. `fi` now treats these inputs in the same way that MATLAB and Simulink handle `-Inf`, `Inf`, and `NaN` for integer data types.

When `fi` is specified as a fixed-point numeric type,

- `NaN` maps to `0`.
- When the `'OverflowAction'` property of the `fi` object is set to `'Wrap'`, `-Inf` and `Inf` map to `0`.
- When the `'OverflowAction'` property of the `fi` object is set to `'Saturate'`, `Inf` maps to the largest representable value, and `-Inf` maps to the smallest representable value.

For an example of this behavior, see “`fi` Behavior for `-Inf`, `Inf`, and `NaN`” on page 4-361.

Note Best-precision scaling is not supported for input values of `-Inf`, `Inf`, or `NaN`.

Extended Capabilities

C/C++ Code Generation

Generate C and C++ code using MATLAB® Coder™.

Usage notes and limitations:

- The default constructor syntax without any input arguments is not supported.
- If the `numericType` is not fully specified, the input to `fi` must be a constant, a `fi`, a `single`, or a built-in integer value. If the input is a built-in double value, it must be a constant. This limitation allows `fi` to autoscale its fraction length based on the known data type of the input.
- All properties related to data type must be constant for code generation.
- `numericType` object information must be available for nonfixed-point Simulink inputs.

HDL Code Generation

Generate Verilog and VHDL code for FPGA and ASIC designs using HDL Coder™.

See Also

`fimath` | `fipref` | `isfimathlocal` | `numericType` | `quantizer` | `sfi` | `ufi`

Topics

“Create Fixed-Point Data”

“Perform Fixed-Point Arithmetic”

“Perform Binary-Point Scaling”

“fi Object Functions”

“Binary Point Interpretation”

Introduced in R2006a

fiaccel

Accelerate fixed-point code and convert floating-point MATLAB code to fixed-point MATLAB code

Syntax

```
fiaccel -options fcn  
fiaccel -float2fixed fcn
```

Description

`fiaccel -options fcn` translates the MATLAB file `fcn.m` to a MEX function, which accelerates fixed-point code. To use `fiaccel`, your code must meet one of these requirements:

- The top-level function has no inputs or outputs, and the code uses `fi`
- The top-level function has an output or a non-constant input, and at least one output or input is a `fi`.
- The top-level function has at least one input or output containing a built-in integer class (`int8`, `uint8`, `int16`, `uint16`, `int32`, `uint32`, `int64`, or `uint64`), and the code uses `fi`.

Note If your top-level file is on a path that contains Unicode characters, code generation might not be able to find the file.

`fiaccel -float2fixed fcn` converts the floating-point MATLAB function, `fcn` to fixed-point MATLAB code.

Input Arguments

fcn

MATLAB function from which to generate a MEX function. `fcn` must be suitable for code generation. For information on code generation, see “Code Acceleration and Code Generation from MATLAB”

options

Choice of compiler options. `fiaccel` gives precedence to individual command-line options over options specified using a configuration object. If command-line options conflict, the rightmost option prevails.

`-args example_inputs`

Define the size, class, and complexity of MATLAB function inputs by providing a cell array of example input values. The position of the example input in the cell array must correspond to the position of the input argument in the MATLAB function definition. To generate a function that has fewer input arguments than the function definition has, omit the example values for the arguments that you do not want.

Specify the example inputs immediately after the function to which they apply.

Instead of an example value, you can provide a `coder.Type` object. To create a `coder.Type` object, use `coder.typeof`.

`-config config_object`

Specify MEX generation parameters, based on *config_object*, defined as a MATLAB variable using `coder.mexconfig`. For example:

```
cfg = coder.mexconfig;
```

`-d out_folder`

Store generated files in the absolute or relative path specified by *out_folder*. If the folder specified by *out_folder* does not exist, `fiaccel` creates it for you.

If you do not specify the folder location, `fiaccel` generates files in the default folder:

```
fiaccel/mex/fcn.
```

fcn is the name of the MATLAB function specified at the command line.

The function does not support the following characters in folder names: asterisk (*), question-mark (?), dollar (\$), and pound (#).

`-float2fixed float2fixed_cfg_name`

Generates fixed-point MATLAB code using the settings specified by the floating-point to fixed-point conversion configuration object named *float2fixed_cfg_name*.

For this option, `fiaccel` generates files in the folder `codegen/fcn_name/fixpt`.

You must set the `TestBenchName` property of *float2fixed_cfg_name*. For example:

```
fixptcfg.TestBenchName = 'myadd_test';
```

specifies that `myadd_test` is the test file for the floating-point to fixed-point configuration object `fixptcfg`.

You cannot use this option with the `-global` option.

`-g`

Compiles the MEX function in debug mode, with optimization turned off. If not specified, `fiaccel` generates the MEX function in optimized mode.

`-global global_values`

Specify initial values for global variables in MATLAB file. Use the values in cell array `global_values` to initialize global variables in the function you compile. The cell array should provide the name and initial value of each global variable. You must initialize global variables before compiling with `fiaccel`. If you do not provide initial values for global variables using the `-global` option, `fiaccel` checks for the variable in the MATLAB global workspace. If you do not supply an initial value, `fiaccel` generates an error.

The generated MEX code and MATLAB each have their own copies of global data. To ensure consistency, you must synchronize their global data whenever the two interact. If you do not synchronize the data, their global variables might differ.

You cannot use this option with the `-float2fixed` option.

`-I include_path`

Add *include_path* to the beginning of the code generation path.

`fiaccel` searches the code generation path *first* when converting MATLAB code to MEX code.

-launchreport	Generate and open a code generation report. If you do not specify this option, <code>fiaccl</code> generates a report only if error or warning messages occur or you specify the <code>-report</code> option.
-nargout	Specify the number of output arguments in the generated entry-point function. The code generator produces the specified number of output arguments in the order in which they occur in the MATLAB function definition.
-o <i>output_file_name</i>	Generate the MEX function with the base name <i>output_file_name</i> plus a platform-specific extension. <i>output_file_name</i> can be a file name or include an existing path. If you do not specify an output file name, the base name is <i>fcn_mex</i> , which allows you to run the original MATLAB function and the MEX function and compare the results.
-O <i>optimization_option</i>	Optimize generated MEX code, based on the value of <i>optimization_option</i> : <ul style="list-style-type: none"> • <code>enable:inline</code> — Enable function inlining • <code>disable:inline</code> — Disable function inlining If not specified, <code>fiaccl</code> uses inlining for optimization.
-report	Generate a code generation report. If you do not specify this option, <code>fiaccl</code> generates a report only if error or warning messages occur or you specify the <code>-launchreport</code> option.
-?	Display help for <code>fiaccl</code> command.

Examples

Create a test file and compute the moving average. Then, use `fiaccl` to accelerate the code and compare.

```
function avg = test_moving_average(x)
%#codegen
if nargin < 1,
    x = fi(rand(100,1),1,16,15);
end
z = fi(zeros(10,1),1,16,15);
avg = x;
for k = 1:length(x)
    [avg(k),z] = moving_average(x(k),z);
end

function [avg,z] = moving_average(x,z)
```

```
 %#codegen
 if nargin < 2,
     z = fi(zeros(10,1),1,16,15);
 end
 z(2:end) = z(1:end-1);    % Update buffer
 z(1) = x;                 % Add new value
 avg = mean(z);           % Compute moving average

 % Use fiaccel to create a MEX function and
 % accelerate the code
 x = fi(rand(100,1),1,16,15);
 fiaccel test_moving_average -args {x} -report

 % Compare the non-accelerated and accelerated code.
 x = fi(rand(100,1),1,16,15);

 % Non-compiled version
 tic,avg = test_moving_average(x);toc
 % Compiled version
 tic,avg = test_moving_average_mex(x);toc
```

Convert Floating-Point MATLAB Code to Fixed Point

Create a `coder.FixPtConfig` object, `fixptcfg`, with default settings.

```
fixptcfg = coder.config('fixpt');
```

Set the test bench name. In this example, the test bench function name is `dti_test`.

```
fixptcfg.TestBenchName = 'dti_test';
```

Convert a floating-point MATLAB function to fixed-point MATLAB code. In this example, the MATLAB function name is `dti`.

```
fiaccel -float2fixed fixptcfg dti
```

See Also

[coder.ArrayType](#) | [coder.Constant](#) | [coder.EnumType](#) | [coder.FiType](#) |
[coder.FixPtConfig](#) | [coder.PrimitiveType](#) | [coder.StructType](#) | [coder.Type](#) |
[coder.config](#) | [coder.mexconfig](#) | [coder.mexconfig](#) | [coder.newtype](#) | [coder.resize](#) |
[coder.typeof](#)

Introduced in R2011a

filter

One-dimensional digital filter of `fi` objects

Syntax

```
y = filter(b,1,x)
[y,zf] = filter(b,1,x,zi)
y = filter(b,1,x,zi,dim)
```

Description

`y = filter(b,1,x)` filters the data in the fixed-point vector `x` using the filter described by the fixed-point vector `b`. The function returns the filtered data in the output `fi` object `y`. Inputs `b` and `x` must be `fi` objects. `filter` always operates along the first non-singleton dimension. Thus, the filter operates along the first dimension for column vectors and nontrivial matrices, and along the second dimension for row vectors.

`[y,zf] = filter(b,1,x,zi)` gives access to initial and final conditions of the delays, `zi`, and `zf`. `zi` is a vector of length `length(b) - 1`, or an array with the leading dimension of size `length(b) - 1` and with remaining dimensions matching those of `x`. `zi` must be a `fi` object with the same data type as `y` and `zf`. If you do not specify a value for `zi`, it defaults to a fixed-point array with a value of 0 and the appropriate `numericType` and size.

`y = filter(b,1,x,zi,dim)` performs the filtering operation along the specified dimension. If you do not want to specify the vector of initial conditions, use `[]` for the input argument `zi`.

Input Arguments

b

Fixed-point vector of the filter coefficients.

x

Fixed-point vector containing the data for the function to filter.

zi

Fixed-point vector containing the initial conditions of the delays. If the initial conditions of the delays are zero, you can specify zero, or, if you do not know the appropriate size and `numericType` for `zi`, use `[]`.

If you do not specify a value for `zi`, the parameter defaults to a fixed-point vector with a value of zero and the same `numericType` and size as the output `zf` (default).

dim

Dimension along which to perform the filtering operation.

Output Arguments

y

Output vector containing the filtered fixed-point data.

zf

Fixed-point output vector containing the final conditions of the delays.

Examples

Filter a high-frequency fixed-point sinusoid from a signal

The following example filters a high-frequency fixed-point sinusoid from a signal that contains both a low- and high-frequency fixed-point sinusoid.

```
w1 = .1*pi;
w2 = .6*pi;
n = 0:999;
xd = sin(w1*n) + sin(w2*n);
x = sfi(xd,12);
b = ufi([.1:.1:1,1-.1:-.1:.1]/4,10);
gd = (length(b)-1)/2;
y = filter(b,1,x);

% Plot results, accommodate for group-delay of filter
plot(n(1:end-gd),x(1:end-gd))
hold on
plot(n(1:end-gd),y(gd+1:end),'r--')
axis([0 50 -2 2])
legend('Unfiltered signal','Filtered signal')
xlabel('Sample index (n)')
ylabel('Signal value')
```

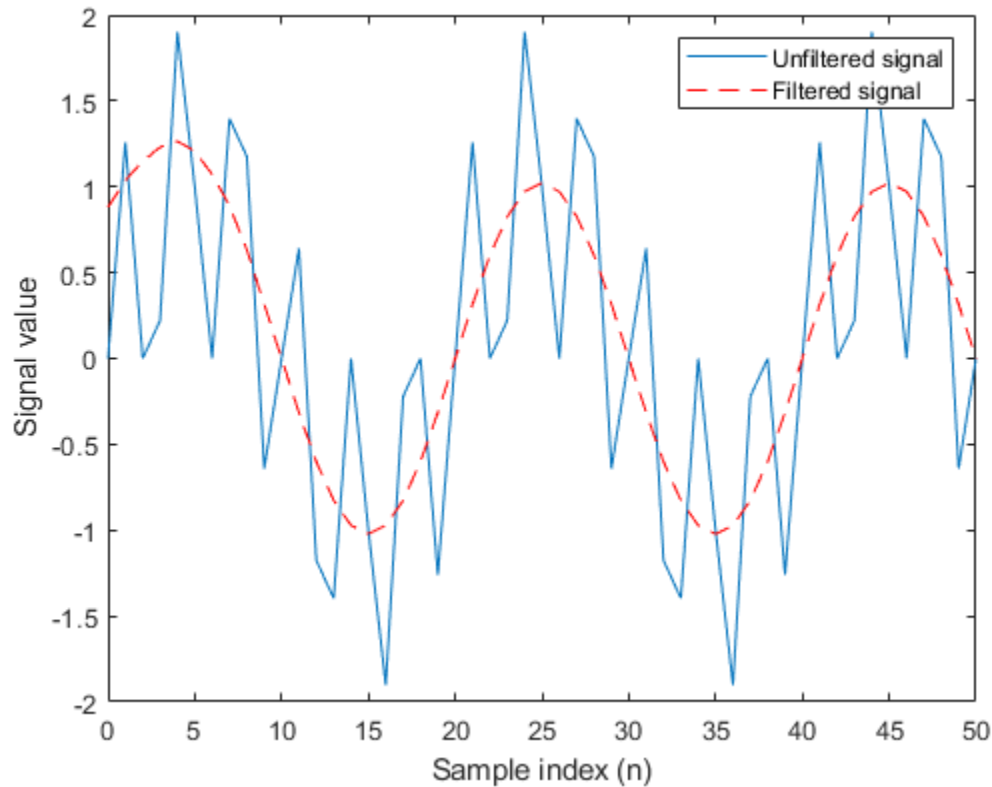

The resulting plot shows both the unfiltered and filtered signals.

More About

Filter length (L)

The filter length is `length(b)`, or the number of filter coefficients specified in the fixed-point vector b .

Filter order (N)

The filter order is the number of states (delays) of the filter, and is equal to $L-1$.

Tips

- The filter function only supports FIR filters. In the general filter representation, b/a , the denominator, a , of an FIR filter is the scalar 1, which is the second input of this function.
- The `numerictype` of b can be different than the `numerictype` of x .
- If you want to specify initial conditions, but do not know what `numerictype` to use, first try filtering your data without initial conditions. You can do so by specifying `[]` for the input z_i . After performing the filtering operation, you have the `numerictype` of y and z_f (if requested). Because the `numerictype` of z_i must match that of y and z_f , you now know the `numerictype` to use for the initial conditions.

Algorithms

The `filter` function uses a Direct-Form Transposed FIR implementation of the following difference equation:

$$y(n) = b_1 * x_n + b_2 * x_{n-1} + \dots + b_L * x_{n-N}$$

where L is the filter length on page 4-371 and N is the filter order on page 4-371.

The following diagram shows the direct-form transposed FIR filter structure used by the `filter` function:

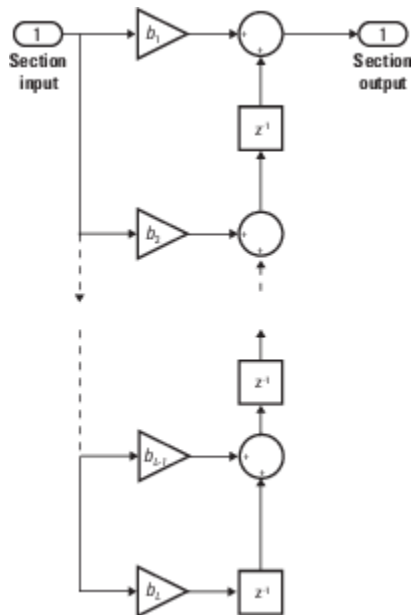

fimath Propagation Rules

The `filter` function uses the following rules regarding `fimath` behavior:

- `globalfimath` is obeyed.
- If any of the inputs has an attached `fimath`, then it is used for intermediate calculations.
- If more than one input has an attached `fimath`, then the `fimaths` must be equal.
- The output, y , is always associated with the default `fimath`.
- If the input vector, z_i , has an attached `fimath`, then the output vector, z_f , retains this `fimath`.

Extended Capabilities

C/C++ Code Generation

Generate C and C++ code using MATLAB® Coder™.

Usage notes and limitations:

- Variable-sized inputs are only supported when the `SumMode` property of the governing `fimath` is set to `Specify precision` or `Keep LSB`.

See Also

conv | filter

Introduced in R2010a

fimath

Set fixed-point math settings

Syntax

```
F = fimath
F = fimath(Name,Value)
```

Description

`F = fimath` creates a `fimath` object with the default `fimath` property settings.

`F = fimath(Name,Value)` specifies the properties of a `fimath` object by using one or more name-value pair arguments. All properties not specified in the constructor use default values.

Examples

Create a Default `fimath` Object

This example shows how to create a `fimath` object with the default property settings.

```
F = fimath
F =
    RoundingMethod: Nearest
    OverflowAction: Saturate
    ProductMode: FullPrecision
    SumMode: FullPrecision
```

Set Properties of a `fimath` Object

Set the properties of a `fimath` object at the time of object creation by using name-value pairs. For example, set the overflow action to saturate and the rounding method to convergent.

```
F = fimath('OverflowAction', 'Saturate', 'RoundingMethod', 'Convergent')
F =
    RoundingMethod: Convergent
    OverflowAction: Saturate
    ProductMode: FullPrecision
    SumMode: FullPrecision
```

Input Arguments

Name-Value Pair Arguments

Specify optional comma-separated pairs of `Name`, `Value` arguments. `Name` is the argument name and `Value` is the corresponding value. `Name` must appear inside quotes. You can specify several name and value pair arguments in any order as `Name1, Value1, ..., NameN, ValueN`.

Example: `F = fimath('OverflowAction','Saturate','RoundingMethod','Floor')`

CastBeforeSum — Whether both operands are cast to the sum data type before addition

`false` or `0` (default) | `true` or `1`

Whether both operands are cast to the sum data type before addition, specified as a numeric or logical `1` (`true`) or `0` (`false`).

Note This property is hidden when the `SumMode` is set to `FullPrecision`.

Example: `F = fimath('CastBeforeSum',true)`

Data Types: `single` | `double` | `int8` | `int16` | `int32` | `int64` | `uint8` | `uint16` | `uint32` | `uint64` | `logical`

MaxProductWordLength — Maximum allowable word length for the product data type

65535 (default) | positive integer

Maximum allowable word length for the product data type, specified as a positive integer.

Example: `F = fimath('MaxProductWordLength',16)`

Data Types: `single` | `double` | `int8` | `int16` | `int32` | `int64` | `uint8` | `uint16` | `uint32` | `uint64`

MaxSumWordLength — Maximum allowable word length for sum data type

65535 (default) | positive integer

Maximum allowable word length for the sum data type, specified as a positive integer.

Example: `F = fimath('MaxSumWordLength',16)`

Data Types: `single` | `double` | `int8` | `int16` | `int32` | `int64` | `uint8` | `uint16` | `uint32` | `uint64`

OverflowAction — Action to take on overflow

'Saturate' (default) | 'Wrap'

Action to take on overflow, specified as one of these values:

- 'Saturate' - Saturate to the maximum or minimum value of the fixed-point range on overflow.
- 'Wrap' - Wrap on overflow. This mode is also known as two's complement overflow.

Example: `F = fimath('OverflowAction','Wrap')`

Data Types: `char`

ProductBias — Bias of product data type

0 (default) | floating-point number

Bias of the product data type, specified as a floating-point number.

Example: `F = fimath('ProductBias',1)`

Data Types: `single` | `double` | `int8` | `int16` | `int32` | `int64` | `uint8` | `uint16` | `uint32` | `uint64`

ProductFixedExponent — Fixed exponent of product data type

`-30` (default) | nonzero integer

Fixed exponent of the product data type, specified as a nonzero integer.

Note The `ProductFractionLength` is the negative of the `ProductFixedExponent`. Changing one property changes the other.

Example: `F = fimath('ProductFixedExponent',-20)`

Data Types: `single` | `double` | `int8` | `int16` | `int32` | `int64` | `uint8` | `uint16` | `uint32` | `uint64`

ProductFractionLength — Fraction length of product data type

`30` (default) | nonzero integer

Fraction length, in bits, of the product data type, specified as a nonzero integer.

Note The `ProductFractionLength` is the negative of the `ProductFixedExponent`. Changing one property changes the other.

Example: `F = fimath('ProductFractionLength',20)`

Data Types: `single` | `double` | `int8` | `int16` | `int32` | `int64` | `uint8` | `uint16` | `uint32` | `uint64`

ProductMode — How product data type is determined

`'FullPrecision'` (default) | `'KeepLSB'` | `'KeepMSB'` | `'SpecifyPrecision'`

How the product data type is determined, specified as one of these values:

- `'FullPrecision'` - The full precision of the result is kept.
- `'KeepLSB'` - Keep the least significant bits. Specify the product word length. The fraction length is set to maintain the least significant bits of the product.
- `'KeepMSB'` - Keep the most significant bits. Specify the product word length. The fraction length is set to maintain the most significant bits of the product.
- `'SpecifyPrecision'` - Specify the word and fraction lengths or slope and bias of the product.

Example: `F = fimath('ProductMode','KeepLSB')`

Data Types: `char`

ProductSlope — Slope of product data type

`9.3132e-10` (default) | finite, positive floating-point number

Slope of the product data type, specified as a finite, positive floating-point number.

Note

$$ProductSlope = ProductSlopeAdjustmentFactor \times 2^{ProductFixedExponent}$$

Changing one of these properties affects the others.

Example: `F = fimath('ProductSlope',9.3132e-10)`

Data Types: `single | double | int8 | int16 | int32 | int64 | uint8 | uint16 | uint32 | uint64`

ProductSlopeAdjustmentFactor — Slope adjustment factor of the product data type

1 (default) | floating-point number greater than or equal to 1 and less than 2

Slope adjustment factor of the product data type, specified as a floating-point number greater than or equal to 1 and less than 2.

Note

$$ProductSlope = ProductSlopeAdjustmentFactor \times 2^{ProductFixedExponent}$$

Changing one of these properties affects the others.

Example: `F = fimath('ProductSlopeAdjustmentFactor',1)`

Data Types: `single | double | int8 | int16 | int32 | int64 | uint8 | uint16 | uint32 | uint64`

ProductWordLength — Word length of product data type

32 (default) | positive integer

Word length, in bits, of the product data type, specified as a positive integer.

Example: `F = fimath('ProductWordLength',64)`

Data Types: `single | double | int8 | int16 | int32 | int64 | uint8 | uint16 | uint32 | uint64`

RoundingMethod — Rounding method to use

'Nearest' (default) | 'Ceiling' | 'Convergent' | 'Zero' | 'Floor' | 'Round'

Rounding method to use, specified as one of these values:

- 'Nearest' - Round toward nearest. Ties round toward positive infinity.
- 'Ceiling' - Round toward positive infinity.
- 'Convergent' - Round toward nearest. Ties round to the nearest even stored integer (least biased).
- 'Zero' - Round toward zero.
- 'Floor' - Round toward negative infinity.
- 'Round' - Round toward nearest. Ties round toward negative infinity for negative numbers, and toward positive infinity for positive numbers.

Example: `F = fimath('RoundingMethod','Convergent')`

Data Types: `char`

SumBias — Bias of sum data type

0 (default) | floating-point number

Bias of the sum data type, specified as a floating-point number.

Example: `F = fimath('SumBias',0)`

Data Types: `single | double | int8 | int16 | int32 | int64 | uint8 | uint16 | uint32 | uint64`

SumFixedExponent — Fixed exponent of sum data type

`-30 (default) | nonzero integer`

Fixed exponent of the sum data type, specified as a nonzero integer.

Note The `SumFractionLength` is the negative of the `SumFixedExponent`. Changing one property changes the other.

Example: `F = fimath('SumFixedExponent',-20)`

Data Types: `single | double | int8 | int16 | int32 | int64 | uint8 | uint16 | uint32 | uint64`

SumFractionLength — Fraction length of sum data type

`30 (default) | nonzero integer`

Fraction length, in bits, of the sum data type, specified as a nonzero integer.

Note The `SumFractionLength` is the negative of the `SumFixedExponent`. Changing one property changes the other.

Example: `F = fimath('SumFractionLength',20)`

Data Types: `single | double | int8 | int16 | int32 | int64 | uint8 | uint16 | uint32 | uint64`

SumMode — How the sum data type is determined

`'FullPrecision' (default) | 'KeepLSB' | 'KeepMSB' | 'SpecifyPrecision'`

How the sum data type is determined, specified as one of these values:

- `'FullPrecision'` - The full precision of the result is kept.
- `'KeepLSB'` - Keep least significant bits. Specify the sum data type word length. The fraction length is set to maintain the least significant bits of the sum.
- `'KeepMSB'` - Keep most significant bits. Specify the sum data type word length. The fraction length is set to maintain the most significant bits of the sum and no more fractional bits than necessary.
- `'SpecifyPrecision'` - Specify the word and fraction lengths or slope and bias of the sum data type.

Example: `F = fimath('SumMode','KeepLSB')`

Data Types: `char`

SumSlope — Slope of sum data type

`9.3132e-10 (default) | floating-point number`

Slope of the sum data type, specified as a floating-point number.

Note

$$\text{SumSlope} = \text{SumSlopeAdjustmentFactor} \times 2^{\text{SumFixedExponent}}$$

Changing one of these properties affects the others.

Example: `F = fimath('SumSlope',9.3132e-10)`

Data Types: `single` | `double` | `int8` | `int16` | `int32` | `int64` | `uint8` | `uint16` | `uint32` | `uint64`

SumSlopeAdjustmentFactor — Slope adjustment factor of the sum data type

1 (default) | floating-point number greater than or equal to 1 and less than 2

Slope adjustment factor of the sum data type, specified as a floating-point number greater than or equal to 1 and less than 2.

Note

$$\text{SumSlope} = \text{SumSlopeAdjustmentFactor} \times 2^{\text{SumFixedExponent}}$$

Changing one of these properties affects the others.

Example: `F = fimath('SumSlopeAdjustmentFactor',1)`

Data Types: `single` | `double` | `int8` | `int16` | `int32` | `int64` | `uint8` | `uint16` | `uint32` | `uint64`

SumWordLength — Word length of sum data type

32 (default) | positive integer

Word length, in bits, of the sum data type, specified as a positive integer.

Example: `F = fimath('SumWordLength',64)`

Data Types: `single` | `double` | `int8` | `int16` | `int32` | `int64` | `uint8` | `uint16` | `uint32` | `uint64`

Extended Capabilities

C/C++ Code Generation

Generate C and C++ code using MATLAB® Coder™.

Usage notes and limitations:

- Fixed-point signals coming in to a MATLAB Function block from Simulink are assigned a `fimath` object. You define this object in the MATLAB Function block dialog in the Model Explorer.
- Use to create `fimath` objects in the generated code.
- If the `ProductMode` property of the `fimath` object is set to anything other than `FullPrecision`, the `ProductWordLength` and `ProductFractionLength` properties must be constant.
- If the `SumMode` property of the `fimath` object is set to anything other than `FullPrecision`, the `SumWordLength` and `SumFractionLength` properties must be constant.

HDL Code Generation

Generate Verilog and VHDL code for FPGA and ASIC designs using HDL Coder™.

See Also

[fi](#) | [fipref](#) | [globalfimath](#) | [numericity](#) | [quantizer](#) | [removefimath](#) | [setfimath](#)

Topics

[“fimath Object Construction”](#)

[“fimath Object Properties”](#)

[How Functions Use fimath](#)

[“fimath Properties Usage for Fixed-Point Arithmetic”](#)

Introduced before R2006a

fipref

Set fixed-point preferences

Syntax

```
P = fipref
P = fipref(Name,Value)
```

Description

`P = fipref` creates a default `fipref` object. The `fipref` object defines the display and logging attributes for all `fi` objects.

`P = fipref(Name,Value)` creates a `fipref` object with properties specified by `Name,Value` pairs.

Your `fipref` settings persist throughout your MATLAB session. Use `reset(fipref)` to return to the default settings during your session. Use `savefipref` to save your display preferences for subsequent MATLAB sessions.

Examples

Create a Default `fipref` Object

```
P = fipref
P =
    NumberDisplay: 'RealWorldValue'
  NumericTypeDisplay: 'full'
    FimathDisplay: 'full'
      LoggingMode: 'Off'
  DataTypeOverride: 'ForceOff'
```

Set `fipref` Properties at Object Creation

You can set properties of `fipref` objects at the time of object creation by including properties after the arguments of the `fipref` constructor function. For example, to set `NumberDisplay` to `bin` and `NumericTypeDisplay` to `short`,

```
P = fipref('NumberDisplay','bin','NumericTypeDisplay','short')
P =
    NumberDisplay: 'bin'
  NumericTypeDisplay: 'short'
    FimathDisplay: 'full'
      LoggingMode: 'Off'
```

```
DataTypeOverride: 'ForceOff'
```

Input Arguments

Name-Value Pair Arguments

Specify optional comma-separated pairs of `Name`, `Value` arguments. `Name` is the argument name and `Value` is the corresponding value. `Name` must appear inside quotes. You can specify several name and value pair arguments in any order as `Name1, Value1, ..., NameN, ValueN`.

Example: `P =`

```
fipref('NumberDisplay', 'RealWorldValue', 'NumericTypeDisplay', 'short');
```

Data Type Override Properties

`DataTypeOverride` — Data type override options

```
'ForceOff' (default) | 'ScaledDoubles' | 'TrueDoubles' | 'TrueSingles'
```

Data type override options for `fi` objects, specified as the comma-separated pair consisting of `'DataTypeOverride'` and one of these values:

- `'ForceOff'` — No data type override
- `'ScaledDoubles'` — Override with scaled doubles
- `'TrueDoubles'` — Override with doubles
- `'TrueSingles'` — Override with singles

Data type override only occurs when the `fi` constructor function is called.

Data Types: `char`

`DataTypeOverrideAppliesTo` — Data type override setting applicability

```
'AllNumericTypes' (default) | 'Fixed-Point' | 'Floating-Point'
```

Data type override setting applicability to `fi` objects, specified as the comma-separated pair consisting of `'DataTypeOverrideAppliesTo'` and one of these values:

- `'AllNumericTypes'` — Apply data type override to all `fi` data types. This setting does not override built-in integer types.
- `'Fixed-Point'` — Apply data type override only to fixed-point data types
- `'Floating-Point'` — Apply data type override only to floating-point `fi` data types

`DataTypeOverrideAppliesTo` displays only if `DataTypeOverride` is not set to `ForceOff`.

Data Types: `char`

Display Properties

`FimathDisplay` — Display options for local `fimath` attributes of `fi` objects

```
'full' (default) | 'none'
```

Display options for the local `fimath` attributes of a `fi` object, specified as the comma-separated pair consisting of `'FimathDisplay'` and one of these values:

- 'full' — Displays all of the `fimath` attributes of a fixed-point object
- 'none' — None of the `fimath` attributes are displayed

Data Types: char

NumberDisplay — Display options for the value of a fi object

'RealWorldValue' (default) | 'bin' | 'dec' | 'hex' | 'int' | 'none'

Display options for the values of a `fi` object, specified as the comma-separated pair consisting of 'NumberDisplay' and one of these values:

- 'bin' — Displays the stored integer value in binary format
- 'dec' — Displays the stored integer value in unsigned decimal format
- 'RealWorldValue' — Displays the stored integer value in the format specified by the MATLAB format function

`fi` objects in `rat` format are displayed according to

$$\frac{1}{(2^{\text{fixed} - \text{pointexponent}})} \times \text{storedinteger}$$

- 'hex' — Displays the stored integer value in hexadecimal format
- 'int' — Displays the stored integer value in signed decimal format
- 'none' — No value is displayed

The stored integer value does not change when you change the `fipref` object. The `fipref` object only affects the display.

Data Types: char

NumericTypeDisplay — Display options for the numeric type attributes of a fi object

'full' (default) | 'none' | 'short'

Display options for the `numeric type` attributes of a `fi` object, specified as the comma-separated pair consisting of 'NumericTypeDisplay' and one of these values:

- 'full' — Displays all of the `numeric type` attributes of a `fi` object
- 'none' — None of the `numeric type` attributes are displayed
- 'short' — Displays the `numeric type` attributes of a `fi` object using the abbreviated notation of the `numeric type` constructor

Data Types: char

Logging Properties

LoggingMode — Logging options for operations performed on fi objects

'off' (default) | 'on'

Logging options for operations performed on `fi` objects, specified as the comma-separated pair consisting of 'LoggingMode' and one of these values:

- 'off' — No logging
- 'on' — Information is logged for future operations

Overflows and underflows for assignment, plus, minus, and multiplication operations are logged as warnings when `LoggingMode` is set to `on`.

When `LoggingMode` is `on`, you can also use the following functions to return logged information about assignment and creation operations to the MATLAB command line:

- `maxlog` — Returns the maximum real-world value
- `minlog` — Returns the minimum value
- `noverflows` — Returns the number of overflows
- `nunderflows` — Returns the number of underflows

`LoggingMode` must be set to `on` before you perform any operation in order to log information about it. To clear the log, use the function `resetlog`.

Data Types: `char`

See Also

`fi` | `fimath` | `numericType` | `quantizer` | `savefipref`

Introduced before R2006a

fix

Round toward zero

Syntax

```
y = fix(a)
```

Description

`y = fix(a)` rounds `fi` object `a` to the nearest integer in the direction of zero and returns the result in `fi` object `y`.

Examples

Use `fix` on a Signed `fi` Object

The following example demonstrates how the `fix` function affects the `numericType` properties of a signed `fi` object with a word length of 8 and a fraction length of 3.

```
a = fi(pi,1,8,3)
```

```
a =
    3.1250
```

```
        DataTypeMode: Fixed-point: binary point scaling
        Signedness: Signed
        WordLength: 8
        FractionLength: 3
```

```
y = fix(a)
```

```
y =
    3
```

```
        DataTypeMode: Fixed-point: binary point scaling
        Signedness: Signed
        WordLength: 5
        FractionLength: 0
```

The following example demonstrates how the `fix` function affects the `numericType` properties of a signed `fi` object with a word length of 8 and a fraction length of 12.

```
a = fi(0.025,1,8,12)
```

```
a =
    0.0249
```

```
        DataTypeMode: Fixed-point: binary point scaling
        Signedness: Signed
        WordLength: 8
        FractionLength: 12
```

```
y = fix(a)
```

```
y =
    0
```

```
DataTypeMode: Fixed-point: binary point scaling
Signedness: Signed
WordLength: 2
FractionLength: 0
```

Compare Rounding Methods

The functions `ceil`, `fix`, and `floor` differ in the way they round `fi` objects:

- The `ceil` function rounds values to the nearest integer toward positive infinity.
- The `fix` function rounds values to the nearest integer toward zero.
- The `floor` function rounds values to the nearest integer toward negative infinity.

This example illustrates these differences for a given `fi` input object `a`.

```
a = fi([-2.5,-1.75,-1.25,-0.5,0.5,1.25,1.75,2.5]');
y = [a ceil(a) fix(a) floor(a)]
```

```
y=8x4 object
-2.5000 -2.0000 -2.0000 -3.0000
-1.7500 -1.0000 -1.0000 -2.0000
-1.2500 -1.0000 -1.0000 -2.0000
-0.5000 0 0 -1.0000
0.5000 1.0000 0 0
1.2500 2.0000 1.0000 1.0000
1.7500 2.0000 1.0000 1.0000
2.5000 3.0000 2.0000 2.0000
```

```
DataTypeMode: Fixed-point: binary point scaling
Signedness: Signed
WordLength: 16
FractionLength: 13
```

```
plot(a,y); legend('a','ceil(a)','fix(a)','floor(a)','location','NW');
```

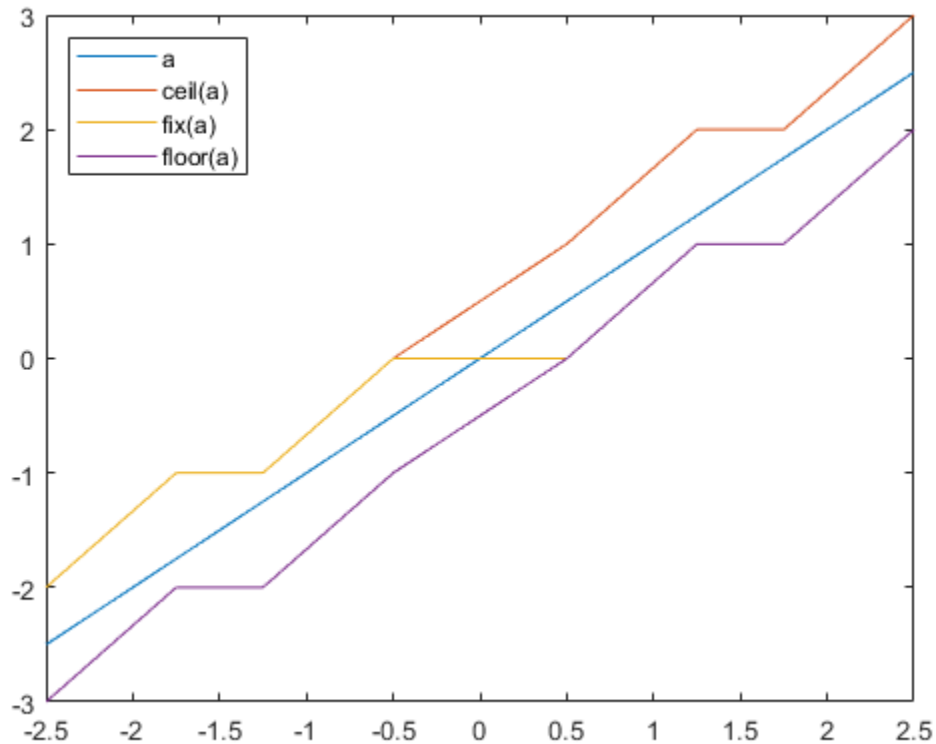

Input Arguments

a — Input `fi` array

scalar | vector | matrix | multidimensional array

Input `fi` array, specified as scalar, vector, matrix, or multidimensional array.

For complex `fi` objects, the imaginary and real parts are rounded independently.

`fix` does not support `fi` objects with nontrivial slope and bias scaling. Slope and bias scaling is trivial when the slope is an integer power of 2 and the bias is 0.

Data Types: `fi`

Complex Number Support: Yes

Algorithms

- `y` and `a` have the same `fi` object and `DataType` property.
- When the `DataType` property of `a` is `single`, `double`, or `boolean`, the `numericType` of `y` is the same as that of `a`.
- When the fraction length of `a` is zero or negative, `a` is already an integer, and the `numericType` of `y` is the same as that of `a`.

- When the fraction length of a is positive, the fraction length of y is 0, its sign is the same as that of a , and its word length is the difference between the word length and the fraction length of a , plus one bit. If a is signed, then the minimum word length of y is 2. If a is unsigned, then the minimum word length of y is 1.

Extended Capabilities

C/C++ Code Generation

Generate C and C++ code using MATLAB® Coder™.

HDL Code Generation

Generate Verilog and VHDL code for FPGA and ASIC designs using HDL Coder™.

See Also

`ceil` | `convergent` | `floor` | `nearest` | `round`

Introduced in R2008a

fixed.extractNumericType

Extract numeric type from input

Syntax

```
T = fixed.extractNumericType(x)
```

Description

T = fixed.extractNumericType(x) returns an embedded.numericType object that is extracted from a numeric value input x, or is specified by the input argument x.

Examples

Extract Numeric Type

Extract the numeric type from an input numeric value.

```
T = fixed.extractNumericType(pi)
```

```
T =
```

```
    DataTypeMode: Double
```

```
T = fixed.extractNumericType(int8(0))
```

```
T =
```

```
    DataTypeMode: Fixed-point: binary point scaling
    Signedness: Signed
    WordLength: 8
    FractionLength: 0
```

```
T = fixed.extractNumericType(fi(pi,1,24,12))
```

```
T =
```

```
    DataTypeMode: Fixed-point: binary point scaling
    Signedness: Signed
    WordLength: 24
    FractionLength: 12
```

```
T = fixed.extractNumericType(half(pi))
```

```
T =
```

```
    DataTypeMode: Half
```

Extract the numeric type from a numeric type specification object.

```
T = fixed.extractNumericType(numerictype(1,32,16))
```

```
T =
```

```
    DataTypeMode: Fixed-point: binary point scaling
      Signedness: Signed
      WordLength: 32
      FractionLength: 16
```

```
T = fixed.extractNumericType(fixdt(0,18,0))
```

```
T =
```

```
    DataTypeMode: Fixed-point: binary point scaling
      Signedness: Unsigned
      WordLength: 18
      FractionLength: 0
```

Extract the numeric type from a data type name string.

```
T = fixed.extractNumericType('int8')
```

```
T =
```

```
    DataTypeMode: Fixed-point: binary point scaling
      Signedness: Signed
      WordLength: 8
      FractionLength: 0
```

```
T = fixed.extractNumericType('sfix16_En3')
```

```
T =
```

```
    DataTypeMode: Fixed-point: binary point scaling
      Signedness: Signed
      WordLength: 16
      FractionLength: 3
```

Extract the numeric type from a constructor string.

```
T = fixed.extractNumericType('numerictype(1,33,55)')
```

```
T =
```

```
    DataTypeMode: Fixed-point: binary point scaling
      Signedness: Signed
      WordLength: 33
      FractionLength: 55
```

```
T = fixed.extractNumericType('fixdt(0,77,22)')
```

```
T =
```

```
    DataTypeMode: Fixed-point: binary point scaling
```



```
Signedness: Unsigned
WordLength: 77
FractionLength: 22
```

Input Arguments

x — Input

scalar

Input, specified as a scalar.

The following input types are supported:

- Numeric values — `half`, `single`, `double`, `int8`, `int16`, `int32`, `int64`, `uint8`, `uint16`, `uint32`, `uint64`, `logical`, `fi`
- Numeric type specification objects — `embedded.numericType` objects, `Simulink.NumericType` objects
- MATLAB data type name strings — `'half'`, `'single'`, `'double'`, `'int8'`, `'int16'`, `'int32'`, `'int64'`, `'uint8'`, `'uint16'`, `'uint32'`, `'uint64'`, `'logical'`
- Simulink data type name strings (not aliases) — `'bool'`, `'sfix16_En3'`, etc.
- Constructor strings that evaluate to a numeric type object — `'numericType(1,33,55)'`, `'fixdt(0,77,22)'`, etc.

Data Types: `single` | `double` | `int8` | `int16` | `int32` | `int64` | `uint8` | `uint16` | `uint32` | `uint64` | `logical` | `fi`

Complex Number Support: Yes

Output Arguments

T — Numeric type of input

`embedded.numericType` object

Numeric type of the input, returned as a `embedded.numericType` object.

See Also

“Fixed-Point Numbers in Simulink” | `Simulink.NumericType` | `fi` | `fixdt` | `numericType`

Introduced in R2021a

fixDiv

Round the result of division toward zero

Syntax

```
y = fixDiv(x,d)
y = fixDiv(x,d,m)
```

Description

`y = fixDiv(x,d)` returns the result of x/d rounded to the nearest integer value in the direction of zero.

`y = fixDiv(x,d,m)` returns the result of x/d rounded to the nearest multiple of m in the direction of zero.

The datatype of y is calculated such that the wordlength and fraction length are of a sufficient size to contain both the largest and smallest possible solutions given the data type of x , and the values of d and m .

Examples

Divide and Round to Zero

Perform a division operation and round to the nearest integer value in the direction of zero.

```
fixDiv(int16(201),10)
```

```
ans =
```

```
20
```

```
DataTypeMode: Fixed-point: binary point scaling
Signedness: Signed
WordLength: 14
FractionLength: 0
```

Perform a division operation and round to the nearest multiple of 7 in the direction of zero.

```
fixDiv(int16(201),10,7)
```

```
ans =
```

```
14
```

```
DataTypeMode: Fixed-point: binary point scaling
Signedness: Signed
```

WordLength: 14
FractionLength: 0

Input Arguments

x — Dividend

scalar

Dividend, specified as a scalar.

Data Types: `single` | `double` | `int8` | `int16` | `int32` | `int64` | `uint8` | `uint16` | `uint32` | `uint64` | `logical` | `fi`

d — Divisor

scalar

Divisor, specified as a scalar.

Data Types: `single` | `double` | `int8` | `int16` | `int32` | `int64` | `uint8` | `uint16` | `uint32` | `uint64` | `logical` | `fi`

m — Value to round to nearest multiple of

1 (default) | scalar

Value to round to nearest multiple of, specified as a scalar.

Data Types: `single` | `double` | `int8` | `int16` | `int32` | `int64` | `uint8` | `uint16` | `uint32` | `uint64` | `logical` | `fi`

Output Arguments

y — Result of division and round to zero

scalar

Result of division and round to zero, returned as a scalar.

The datatype of `y` is calculated such that the wordlength and fraction length are of a sufficient size to contain both the largest and smallest possible solutions given the data type of `x`, and the values of `d` and `m`.

Extended Capabilities

C/C++ Code Generation

Generate C and C++ code using MATLAB® Coder™.

Slope-bias representation is not supported for fixed-point data types.

Fixed-Point Conversion

Design and simulate fixed-point systems using Fixed-Point Designer™.

Slope-bias representation is not supported for fixed-point data types.

See Also

`ceilDiv` | `floorDiv` | `nearestDiv`

Introduced in R2021a

fixed.aggregateType

Compute aggregate numerictype

Syntax

```
aggNT = fixed.aggregateType(A,B)
```

Description

`aggNT = fixed.aggregateType(A,B)` computes the smallest binary point scaled numerictype that is able to represent both the full range and precision of inputs A and B.

Input Arguments

A

An integer, binary point scaled fixed-point `fi` object, or numerictype object.

B

An integer, binary point scaled fixed-point `fi` object, or numerictype object.

Output Arguments

aggNT

A numerictype object.

Examples

Compute the aggregate numerictype of two numerictype objects.

```
% can represent range [-4,4) and precision 2^-13
a_nt = numerictype(1,16,13);
% can represent range [-2,2) and precision 2^-16
b_nt = numerictype(1,18,16);

% can represent range [-4,4) and precision 2^-16
aggNT = fixed.aggregateType(a_nt,b_nt)
aggNT =
```

```
        DataTypeMode: Fixed-point: binary point scaling
           Signedness: Signed
           WordLength: 19
        FractionLength: 16
```

Compute the aggregate numerictype of two `fi` objects.

```
% Unsigned, WordLength: 16, FractionLength: 14
a_fi = ufi(pi,16);
```

```
% Signed, WordLength: 24, FractionLength: 21
b_fi = sfi(-pi,24);

% Signed, WordLength: 24, FractionLength: 21
aggNT = fixed.aggregateType(a_fi,b_fi)
aggNT =

        DataTypeMode: Fixed-point: binary point scaling
          Signedness: Signed
           WordLength: 24
    FractionLength: 21
```

Compute the aggregate numerictype of a fi object and an integer.

```
% Unsigned, WordLength: 16, FractionLength: 14
% can represent range [0,3] and precision 2^-14
a_fi = ufi(pi,16);
% Unsigned, WordLength: 8, FractionLength: 0
% can represent range [0,255] and precision 2^0
cInt = uint8(0);

% Unsigned with WordLength: 14+8, FractionLength: 14
% can represent range [0,255] and precision 2^-14
aggNT = fixed.aggregateType(a_fi,cInt)
aggNT =

        DataTypeMode: Fixed-point: binary point scaling
          Signedness: Unsigned
           WordLength: 22
    FractionLength: 14
```

See Also

fi | numerictype

Introduced in R2011b

fixed.backwardSubstitute

Solve upper-triangular system of equations through backward substitution

Syntax

```
x = fixed.backwardSubstitute(R, C)
x = fixed.backwardSubstitute(R, C, outputType)
```

Description

`x = fixed.backwardSubstitute(R, C)` performs backward substitution on upper-triangular matrix R to compute $x = R \setminus C$.

`x = fixed.backwardSubstitute(R, C, outputType)` returns $x = R \setminus C$, where the data type of output variable, x , is specified by `outputType`.

Examples

Solve a System of Equations Using Forward and Backward Substitution

This example shows how to solve the system of equations $(A'A)x = B$ using forward and backward substitution.

Specify the input variables, A and B .

```
rng default;
A = gallery('randsvd', [5,3], 1000);
b = [1; 1; 1; 1; 1];
```

Compute the upper-triangular factor, R , of A , where $A = QR$.

```
R = fixed.qlessQR(A);
```

Use forward and backward substitution to compute the value of X .

```
X = fixed.forwardSubstitute(R,b);
X(:) = fixed.backwardSubstitute(R,X)
```

```
X = 5×1
105 ×
```

```
-0.9088
 2.7123
-0.8958
 0
 0
```

This solution is equivalent to using the `fixed.qlessQRMatrixSolve` function.

```
x = fixed.qlessQRMatrixSolve(A,b)
```

```
x = 5x1
10^5 x

-0.9088
 2.7123
-0.8958
      0
      0
```

Input Arguments

R — Upper-triangular input matrix

matrix

Upper triangular input, specified as a matrix.

Data Types: `single` | `double` | `fi`

Complex Number Support: Yes

C — Linear system factor

matrix

Linear system factor, specified as a matrix.

Data Types: `single` | `double` | `fi`

Complex Number Support: Yes

outputType — Output data type

`numericType` object | numeric variable

Output data type, specified as a `numericType` object or a numeric variable. If `outputType` is specified as a `numericType` object, the output, `x`, will have the specified data type. If `outputType` is specified as a numeric variable, `x` will have the same data type as the numeric variable.

Data Types: `single` | `double` | `int8` | `int16` | `int32` | `int64` | `uint8` | `uint16` | `uint32` | `uint64` | `logical` | `fi` | `numericType`

Output Arguments

x — Solution

matrix

Solution, returned as a matrix satisfying the equation $x = R \setminus C$.

Extended Capabilities

C/C++ Code Generation

Generate C and C++ code using MATLAB® Coder™.

Generate code for double-precision, single-precision, and fixed-point data types.

Fixed-Point Conversion

Design and simulate fixed-point systems using Fixed-Point Designer™.

R and C must be signed and use binary-point scaling. Slope-bias representation is not supported for fixed-point data types.

See Also

`fixed.forwardSubstitute` | `fixed.qlessQR` | `fixed.qlessQRMatrixSolve` |
`fixed.qlessQRUpdate` | `fixed.qrAB` | `fixed.qrMatrixSolve`

Introduced in R2020b

fixed.forwardSubstitute

Solve lower-triangular system of equations through forward substitution

Syntax

```
x = fixed.forwardSubstitute(R, B)
x = fixed.forwardSubstitute(R, B, outputType)
```

Description

`x = fixed.forwardSubstitute(R, B)` performs forward substitution on upper-triangular matrix R to compute $x = R \setminus B$.

`x = fixed.forwardSubstitute(R, B, outputType)` returns $x = R \setminus B$, where the data type of output variable, x , is specified by `outputType`.

Examples

Solve a System of Equations Using Forward and Backward Substitution

This example shows how to solve the system of equations $(A'A)x = B$ using forward and backward substitution.

Specify the input variables, A and B .

```
rng default;
A = gallery('randsvd', [5,3], 1000);
b = [1; 1; 1; 1; 1];
```

Compute the upper-triangular factor, R , of A , where $A = QR$.

```
R = fixed.qlessQR(A);
```

Use forward and backward substitution to compute the value of X .

```
X = fixed.forwardSubstitute(R,b);
X(:) = fixed.backwardSubstitute(R,X)
```

```
X = 5×1
105 ×
```

```
-0.9088
 2.7123
-0.8958
 0
 0
```

This solution is equivalent to using the `fixed.qlessQRMatrixSolve` function.

```
x = fixed.qlessQRMatrixSolve(A,b)
```

```
x = 5x1
105 x

-0.9088
 2.7123
-0.8958
      0
      0
```

Input Arguments

R — Upper-triangular input matrix
matrix

Upper triangular input, specified as a matrix.

Data Types: `single` | `double` | `fi`
Complex Number Support: Yes

B — Linear system factor
matrix

Linear system factor, specified as a matrix.

Data Types: `single` | `double` | `fi`
Complex Number Support: Yes

outputType — Output data type
numericType object | numeric variable

Output data type, specified as a `numericType` object or a numeric variable. If `outputType` is specified as a `numericType` object, the output, `x`, will have the specified data type. If `outputType` is specified as a numeric variable, `x` will have the same data type as the numeric variable.

Data Types: `single` | `double` | `int8` | `int16` | `int32` | `int64` | `uint8` | `uint16` | `uint32` | `uint64` | `logical` | `fi` | `numericType`

Output Arguments

x — Solution
matrix

Solution, returned as a matrix satisfying the equation $x = R \setminus B$.

Extended Capabilities

C/C++ Code Generation

Generate C and C++ code using MATLAB® Coder™.

Generate code for double-precision, single-precision, and fixed-point data types.

Fixed-Point Conversion

Design and simulate fixed-point systems using Fixed-Point Designer™.

R and B must be signed and use binary-point scaling. Slope-bias representation is not supported for fixed-point data types.

See Also

`fixed.backwardSubstitute` | `fixed.qlessQR` | `fixed.qlessQRMatrixSolve` |
`fixed.qlessQRUpdate` | `fixed.qrAB` | `fixed.qrMatrixSolve`

Introduced in R2020b

fixed.qlessQR

Q-less QR decomposition

Syntax

```
R = fixed.qlessQR(A)
R = fixed.qlessQR(A, forgettingFactor)
```

Description

`R = fixed.qlessQR(A)` returns the upper-triangular R factor of the QR decomposition $A = QR$.

This is equivalent to computing

```
[~,R] = qr(A)
```

`R = fixed.qlessQR(A, forgettingFactor)` returns the upper-triangular R factor of the QR decomposition and multiplies R by the `forgettingFactor` after each row of A is processed.

Examples

Solve a System of Equations Using Forward and Backward Substitution

This example shows how to solve the system of equations $(A'A)x = B$ using forward and backward substitution.

Specify the input variables, A and B.

```
rng default;
A = gallery('randsvd', [5,3], 1000);
b = [1; 1; 1; 1; 1];
```

Compute the upper-triangular factor, R, of A, where $A = QR$.

```
R = fixed.qlessQR(A);
```

Use forward and backward substitution to compute the value of X.

```
X = fixed.forwardSubstitute(R,b);
X(:) = fixed.backwardSubstitute(R,X)
```

```
X = 5×1
105 ×

-0.9088
 2.7123
-0.8958
 0
 0
```

This solution is equivalent to using the `fixed.qlessQRMatrixSolve` function.

```
x = fixed.qlessQRMatrixSolve(A,b)
```

```
x = 5×1
105 ×
```

```
-0.9088
 2.7123
-0.8958
      0
      0
```

Compute Upper-Triangular Matrix Factor Using Forgetting Factor

Using a forgetting factor with the `fixed.qlessQR` function is roughly equivalent to the Complex- and Real Partial-Systolic Q-less QR with Forgetting Factor blocks. These blocks process one row of the input matrix at a time and apply the forgetting factor after each row is processed. The `fixed.qlessQR` function takes in all rows of A at once, but carries out the computation in the same way as the blocks. The forgetting factor is applied after each row is processed.

Specifying a forgetting factor is useful when you want to stream an indefinite number of rows continuously, such as reading values from a sensor array continuously, without accumulating the data without bound.

Without using a forgetting factor, the accumulation is the square root of the number of rows, so 10000 rows would accumulate to $\sqrt{10000} = 100$.

```
A = ones(10000,3);
R = fixed.qlessQR(A)
```

```
R = 3×3
```

```
100.0000 100.0000 100.0000
      0      0.0000      0.0000
      0      0      0.0000
```

To accrue with the effective height of $m=16$ rows, set the forgetting factor to the following.

```
m=16;
forgettingFactor = exp(-1/(2*m))
```

```
forgettingFactor = 0.9692
```

Using the forgetting factor, `fixed.qlessQR` would accumulate to about square root of 16.

```
R = fixed.qlessQR(A, forgettingFactor)
```

```
R = 3×3
```

```
3.9377 3.9377 3.9377
      0 0.0000 0.0000
      0      0 0.0000
```

Input Arguments

A — Input matrix

matrix

Input matrix, specified as a matrix.

Data Types: `single` | `double` | `fi`

Complex Number Support: Yes

forgettingFactor — Forgetting factor

nonnegative scalar

Forgetting factor, specified as a nonnegative scalar between 0 and 1. The forgetting factor determines how much weight past data is given. The `forgettingFactor` value is multiplied by R after each row of A is processed.

Data Types: `single` | `double` | `int8` | `int16` | `int32` | `int64` | `uint8` | `uint16` | `uint32` | `uint64` | `fi`

Output Arguments

R — Upper-triangular factor

matrix

Upper-triangular factor, returned as a matrix that satisfies $A = Q*R$.

Extended Capabilities

C/C++ Code Generation

Generate C and C++ code using MATLAB® Coder™.

Generate code for double-precision, single-precision, and fixed-point data types.

Fixed-Point Conversion

Design and simulate fixed-point systems using Fixed-Point Designer™.

A must be signed and use binary-point scaling. Slope-bias representation is not supported for fixed-point data types.

See Also

`fixed.backwardSubstitute` | `fixed.forwardSubstitute` | `fixed.qlessQRMatrixSolve` | `fixed.qlessQRUpdate` | `fixed.qrAB` | `fixed.qrMatrixSolve`

Introduced in R2020b

fixed.qlessQRMatrixSolve

Solve system of linear equations $(A'A)x = B$ for x using Q-less QR decomposition

Syntax

```
x = fixed.qlessQRMatrixSolve(A, B)
x = fixed.qlessQRMatrixSolve(A, B, outputType)
x = fixed.qlessQRMatrixSolve(A, B, outputType, forgettingFactor)
```

Description

`x = fixed.qlessQRMatrixSolve(A, B)` solves the system of linear equations $(A'A)x = B$ using QR decomposition, without computing the Q value.

The result of this code is equivalent to computing

```
[~,R] = qr(A,0);
x = R \ (R' \ B)
```

or

```
x = (A' * A) \ B
```

`x = fixed.qlessQRMatrixSolve(A, B, outputType)` returns the solution to the system of linear equations $(A'A)x = B$ as a variable with the output type specified by `outputType`.

`x = fixed.qlessQRMatrixSolve(A, B, outputType, forgettingFactor)` returns the solution to the system of linear equations, with the `forgettingFactor` multiplied by R after each row of A is processed.

Examples

Solve a System of Equations Using Q-Less QR Decomposition

This example shows how to solve the system of linear equations $(A'A)x = b$ using QR decomposition, without explicitly calculating the Q factor of the QR decomposition.

```
rng('default');
m = 6;
n = 3;
p = 1;
A = randn(m,n);
b = randn(n,p);
x = fixed.qlessQRMatrixSolve(A,b)

x = 3×1

    0.2991
    0.0523
    0.4182
```

The `fixed.qlessQRMatrixSolve` function is equivalent to the following code, however the `fixed.qlessQRMatrixSolve` function is more efficient and supports fixed-point data types.

```
x = (A'*A)\b
x = 3×1

    0.2991
    0.0523
    0.4182
```

Solve System of Equations Specifying an Output Data Type

This example shows how to specify an output data type to solve a system of equations with fixed-point data.

Define the data representing the system of equations. Define the matrix A as a zero-mean, normally distributed random matrix with a standard deviation of 1.

```
rng('default');
m = 6;
n = 3;
p = 1;
A0 = randn(m,n);
b0 = randn(n,p);
```

Specify fixed-point data types for A and b as to avoid overflow during the computation of QR.

```
T.A = fi([],1,22,16);
T.b = fi([],1,22,16);
A = cast(A0, 'like', T.A)
```

```
A=6×3 object
    0.5377    -0.4336     0.7254
    1.8339     0.3426    -0.0630
   -2.2589     3.5784     0.7147
    0.8622     2.7694    -0.2050
    0.3188    -1.3499    -0.1241
   -1.3077     3.0349     1.4897
```

```
    DataTypeMode: Fixed-point: binary point scaling
    Signedness: Signed
    WordLength: 22
    FractionLength: 16
```

```
b = cast(b0, 'like', T.b)
```

```
b=3×1 object
    1.4090
    1.4172
    0.6715
```

```
    DataTypeMode: Fixed-point: binary point scaling
    Signedness: Signed
```

```

        WordLength: 22
    FractionLength: 16

```

Specify an output data type to avoid overflow in the back-substitution.

```
T.x = fi([],1,29,12);
```

Use the `fixed.qlessQRMatrixSolve` function to compute the solution, `x`.

```
x = fixed.qlessQRMatrixSolve(A,b,T.x)
```

```

x=3x1 object
    0.2988
    0.0522
    0.4180

```

```

        DataTypeMode: Fixed-point: binary point scaling
        Signedness: Signed
        WordLength: 29
    FractionLength: 12

```

```

        RoundingMethod: Floor
        OverflowAction: Wrap
        ProductMode: SpecifyPrecision
    ProductWordLength: 29
    ProductFractionLength: 12
        SumMode: SpecifyPrecision
        SumWordLength: 29
    SumFractionLength: 12
    CastBeforeSum: true

```

Compare this result to the result of the built-in MATLAB® operations in double-precision floating-point.

```
x0 = (A0'*A0)\b0
```

```

x0 = 3x1
    0.2991
    0.0523
    0.4182

```

Input Arguments

A — Coefficient matrix

matrix

Coefficient matrix in the linear system of equations $(A'A)x = B$.

Data Types: `single` | `double` | `fi`
 Complex Number Support: Yes

B — Input array

vector | matrix

Input vector or matrix representing B in the linear system of equations $(A'A)x = B$.

Data Types: `single` | `double` | `fi`

Complex Number Support: Yes

outputType — Output data type

`numericType` object | numeric variable

Output data type, specified as a `numericType` object or a numeric variable. If `outputType` is specified as a `numericType` object, the output, x , will have the specified data type. If `outputType` is specified as a numeric variable, x will have the same data type as the numeric variable.

Data Types: `single` | `double` | `int8` | `int16` | `int32` | `int64` | `uint8` | `uint16` | `uint32` | `uint64` | `fi` | `numericType`

forgettingFactor — Forgetting factor

nonnegative scalar

Forgetting factor, specified as a nonnegative scalar between 0 and 1. The forgetting factor determines how much weight past data is given. The `forgettingFactor` value is multiplied by the output of the QR decomposition, R after each row of A is processed.

Data Types: `single` | `double` | `int8` | `int16` | `int32` | `int64` | `uint8` | `uint16` | `uint32` | `uint64` | `fi`

Output Arguments

x — Solution

vector | matrix

Solution, returned as a vector or matrix. If A is an m -by- n matrix and B is an m -by- p matrix, then x is an n -by- p matrix.

Extended Capabilities

C/C++ Code Generation

Generate C and C++ code using MATLAB® Coder™.

Generate code for double-precision, single-precision, and fixed-point data types.

Fixed-Point Conversion

Design and simulate fixed-point systems using Fixed-Point Designer™.

A and B must be signed and use binary-point scaling. Slope-bias representation is not supported for fixed-point data types.

See Also

`fixed.backwardSubstitute` | `fixed.forwardSubstitute` | `fixed.qlessQR` | `fixed.qlessQRUpdate` | `fixed.qrAB` | `fixed.qrMatrixSolve`

Introduced in R2020b

fixed.qlessQRUpdate

Update QR factorization

Syntax

```
R = fixed.qlessQRUpdate(R, y)
R = fixed.qlessQRUpdate(R, y, forgettingFactor)
```

Description

`R = fixed.qlessQRUpdate(R, y)` updates upper-triangular `R` with vector `y`.

This syntax is equivalent to

```
[~,R] = qr([R;y],0);
```

`R = fixed.qlessQRUpdate(R, y, forgettingFactor)` updates upper-triangular `R` with vector `y` and multiplies the result by the value specified by `forgettingFactor`.

This syntax is equivalent to

```
[~,R] = qr([R;y],0);
R(:) = forgettingFactor * R;
```

Examples

Update the Upper-Triangular Factor of a Matrix

This example shows how to update the upper-triangular factor of a matrix as new data streams in.

Define a matrix and compute the upper-triangular factor, `R`, using the `fixed.qlessQR` function.

```
rng('default');
m = 20;
n = 4;
A = randn(m,n)
```

`A = 20×4`

```
    0.5377    0.6715   -0.1022   -1.0891
    1.8339   -1.2075   -0.2414    0.0326
   -2.2588    0.7172    0.3192    0.5525
    0.8622    1.6302    0.3129    1.1006
    0.3188    0.4889   -0.8649    1.5442
   -1.3077    1.0347   -0.0301    0.0859
   -0.4336    0.7269   -0.1649   -1.4916
    0.3426   -0.3034    0.6277   -0.7423
    3.5784    0.2939    1.0933   -1.0616
    2.7694   -0.7873    1.1093    2.3505
    :
```

```
R = fixed.qlessQR(A)
```

```
R = 4×4
```

```

  7.1017   -2.0103    1.1646    0.7999
      0     4.8784    0.5745   -0.3222
      0      0     3.1658   -0.4570
      0      0      0      4.4965

```

As new data arrives, for example new values from a sensor array, you can use the `fixed.qlessQRUpdate` function to update the upper-triangular factor with the new data.

```
y1 = [1,1,1,1];
```

```
R = fixed.qlessQRUpdate(R,y1)
```

```
R = 4×4
```

```

  7.1718   -1.8513    1.2927    0.9315
      0     5.0412    0.7646   -0.0904
      0      0     3.2332   -0.2584
      0      0      0      4.6074

```

```
y2 = [1,1,1,1];
```

```
R = fixed.qlessQRUpdate(R,y2)
```

```
R = 4×4
```

```

  7.2411   -1.6954    1.4184    1.0607
      0     5.1929    0.9371    0.1191
      0      0     3.2892   -0.0962
      0      0      0      4.6928

```

The result of updating the upper-triangular factor as new data arrives is equivalent to computing the upper-triangular factor with all of the data.

```
R = fixed.qlessQR([A;y1;y2])
```

```
R = 4×4
```

```

  7.2411   -1.6954    1.4184    1.0607
      0     5.1929    0.9371    0.1191
      0      0     3.2892   -0.0962
      0      0      0      4.6928

```

When you want to stream an indefinite number of rows continuously, such as reading values from a sensor array continuously, without accumulating the data without bound, specify a forgetting factor.

```
forgettingFactor = exp(-1/(2*m))
```

```
forgettingFactor = 0.9753
```

```
y3 = [1, 1, 1, 1];
```

```
R = fixed.qlessQRUpdate(R,y3,forgettingFactor)
```

```
R = 4×4
```

7.1294	-1.5046	1.5038	1.1582
0	5.2031	1.0676	0.3020
0	0	3.2543	0.0379
0	0	0	4.6431

Input Arguments

R — Upper-triangular input matrix

matrix

Upper triangular input, specified as a matrix.

Data Types: `single` | `double` | `fi`

Complex Number Support: Yes

y — Measurement vector

vector

Measurement input, specified as a vector.

Data Types: `single` | `double` | `fi`

Complex Number Support: Yes

forgettingFactor — Forgetting factor

nonnegative scalar

Forgetting factor, specified as a nonnegative scalar between 0 and 1. The forgetting factor determines how much weight past data is given. The `forgettingFactor` value is multiplied by *R* after each row of *R* is processed.

Data Types: `single` | `double` | `int8` | `int16` | `int32` | `int64` | `uint8` | `uint16` | `uint32` | `uint64` | `fi`

Output Arguments

R — Updated upper-triangular matrix

matrix

Updated upper-triangular factor, returned as a matrix.

Extended Capabilities

C/C++ Code Generation

Generate C and C++ code using MATLAB® Coder™.

Generate code for double-precision, single-precision, and fixed-point data types.

Fixed-Point Conversion

Design and simulate fixed-point systems using Fixed-Point Designer™.

R and *y* must be signed and use binary-point scaling. Slope-bias representation is not supported for fixed-point data types.

See Also

`fixed.backwardSubstitute` | `fixed.forwardSubstitute` | `fixed.qlessQR` |
`fixed.qlessQRMatrixSolve` | `fixed.qrAB` | `fixed.qrMatrixSolve`

Introduced in R2020b

fixed.qrAB

Compute $C = Q^*B$ and upper-triangular factor R

Syntax

```
[C, R] = fixed.qrAB(A, B)
[C, R] = fixed.qrAB(A, B, regularizationParameter)
```

Description

`[C, R] = fixed.qrAB(A, B)` computes $C = Q^*B$ and upper-triangular factor R . The function simultaneously performs Givens rotations to A and B to transform A into R and B into C .

This syntax is equivalent to

```
[C,R] = qr(A,B)
```

`[C, R] = fixed.qrAB(A, B, regularizationParameter)` computes C and R using a regularization parameter value specified by `regularizationParameter`. When a regularization parameter is specified, the function simultaneously performs Givens rotations to transform

$$\begin{bmatrix} \lambda I_n \\ A \end{bmatrix} \rightarrow R$$

and

$$\begin{bmatrix} 0_{n,p} \\ B \end{bmatrix} \rightarrow C$$

where A is an m -by- n matrix, B is a m -by- p matrix, and λ is the regularization parameter.

This syntax is equivalent to

```
[Q,R] = qr([regularizationParameter*eye(n); A], 0);
C = Q' [zeros(n,p);B];
```

Examples

Compute C and R Factors

This example shows how to compute the upper-triangular factor R , and $C = Q^*b$.

Define the input matrices, A , and b .

```
rng('default');
m = 6;
n = 3;
p = 1;
A = randn(m,n)
```



```
A = 6×3
```

```
    0.5377   -0.4336    0.7254
    1.8339    0.3426   -0.0631
   -2.2588    3.5784    0.7147
    0.8622    2.7694   -0.2050
    0.3188   -1.3499   -0.1241
   -1.3077    3.0349    1.4897
```

```
b = randn(m,p)
```

```
b = 6×1
```

```
    1.4090
    1.4172
    0.6715
   -1.2075
    0.7172
    1.6302
```

The `fixed.qrAB` function returns the upper-triangular factor, R , and $C = Q'b$.

```
[C, R] = fixed.qrAB(A,b)
```

```
C = 3×1
```

```
   -0.3284
    0.4055
    2.5481
```

```
R = 3×3
```

```
    3.3630   -2.8841   -1.0421
         0    4.8472    0.6885
         0         0    1.3258
```

Solve System of Linear Equations Using Regularization

This example shows how to solve a system of linear equations, $Ax = b$, by computing the upper-triangular factor R , and $C = Q'b$. A regularization parameter can improve the conditioning of least squares problems, and reduce the variance of the estimates when solving linear systems of equations.

Define input matrices, A , and b .

```
rng('default');
m = 50;
n = 5;
p = 1;
A = randn(m,n);
b = randn(m,p);
```

Use the `fixed.qrAB` function to compute the upper-triangular factor, R , and $C = Q'b$.

```
[C, R] = fixed.qrAB(A, b, 0.01)
```

```
C = 5×1
```

```
-0.6361
 1.7663
 1.5892
-2.0638
-0.1327
```

```
R = 5×5
```

```
 9.0631    0.7471    0.4126   -0.3606    0.1883
      0     7.2515   -1.1145    0.6011   -0.7544
      0      0     7.6132   -0.9460   -0.7062
      0      0      0     6.3065   -2.3238
      0      0      0      0     5.9297
```

Use this result to solve $Ax = b$ using $x = R \setminus C$. Compute $x = R \setminus C$ using the `fixed.qrMatrixSolve` function.

```
x = fixed.qrMatrixSolve(R,C)
```

```
x = 5×1
```

```
-0.1148
 0.2944
 0.1650
-0.3355
-0.0224
```

Compare the result to computing $x = A \setminus b$ directly.

```
x = A\b
```

```
x = 5×1
```

```
-0.1148
 0.2944
 0.1650
-0.3355
-0.0224
```

Input Arguments

A — Input coefficient matrix

matrix

Input coefficient matrix, specified as a matrix.

Data Types: `single` | `double` | `fi`

Complex Number Support: Yes

B — Right-hand side matrix

matrix

Right-hand side matrix, specified as a matrix.

Data Types: `single` | `double` | `fi`

Complex Number Support: Yes

regularizationParameter — Regularization parameter

nonnegative scalar

Regularization parameter, specified as a non-negative scalar. Small, positive values of the regularization parameter can improve the conditioning of the problem and reduce the variance of the estimates. While biased, the reduced variance of the estimate often results in a smaller mean squared error when compared to least-squares estimates.

Data Types: `single` | `double` | `int8` | `int16` | `int32` | `int64` | `uint8` | `uint16` | `uint32` | `uint64` | `fi`

Output Arguments**C — Linear system factor**

matrix

Linear system factor, returned as a matrix that satisfies $C = Q'B$.

R — Upper-triangular factor

matrix

Upper-triangular factor, returned as a matrix that satisfies $A = Q'R$.

Extended Capabilities**C/C++ Code Generation**

Generate C and C++ code using MATLAB® Coder™.

Generate code for double-precision, single-precision, and fixed-point data types.

Fixed-Point Conversion

Design and simulate fixed-point systems using Fixed-Point Designer™.

A and B must be signed and use binary-point scaling. Slope-bias representation is not supported for fixed-point data types.

See Also

`fixed.backwardSubstitute` | `fixed.forwardSubstitute` | `fixed.qlessQR` | `fixed.qlessQRMatrixSolve` | `fixed.qlessQRUpdate` | `fixed.qrMatrixSolve`

Introduced in R2020b

fixed.qrMatrixSolve

Solve system of linear equations $Ax = B$ for x using QR decomposition

Syntax

```
x = fixed.qrMatrixSolve(A, B)
x = fixed.qrMatrixSolve(A, B, outputType)
x = fixed.qrMatrixSolve(A, B, outputType, regularizationParameter)
```

Description

$x = \text{fixed.qrMatrixSolve}(A, B)$ solves the system of linear equations $Ax = B$ using QR decomposition.

$x = \text{fixed.qrMatrixSolve}(A, B, \text{outputType})$ returns the solution to the system of linear equations $Ax = B$ as a variable with the output type specified by `outputType`.

$x = \text{fixed.qrMatrixSolve}(A, B, \text{outputType}, \text{regularizationParameter})$ returns the solution to the system of linear equations

$$\begin{bmatrix} \lambda I_n \\ A \end{bmatrix} x = \begin{bmatrix} 0_{n,p} \\ B \end{bmatrix}$$

where A is an m -by- n matrix, B is an m -by- p matrix, and λ is the regularization parameter.

Examples

Solve a System of Equations Using QR Decomposition

This example shows how to solve a simple system of linear equations $Ax = b$, using QR decomposition.

In this example, define A as a 5-by-3 matrix with a large condition number. To solve a system of linear equations involving ill-conditioned (large condition number) non-square matrices, you must use QR decomposition.

```
rng default;
A = gallery('randsvd', [5,3], 1000000);
b = [1; 1; 1; 1; 1];
x = fixed.qrMatrixSolve(A,b)
```

```
x = 3×1
104 ×

-2.3777
 7.0686
-2.2703
```

Compare the result of the `fixed.qrMatrixSolve` function with the result of the `mldivide` or `\` function.

```
x = A\b
```

```
x = 3×1
104 ×
```

```
-2.3777
 7.0686
-2.2703
```

Specify Regularization Parameter in an Overdetermined System

This example shows the effect of a regularization parameter when solving an overdetermined system. In this example, a quantity y is measured at several different values of time t to produce the following observations.

```
t = [0 .3 .8 1.1 1.6 2.3]';
y = [.82 .72 .63 .60 .55 .50]';
```

Model the data with a decaying exponential function

$$y(t) = c_1 + c_2 e^{-t}.$$

The preceding equation says that the vector y should be approximated by a linear combination of two other vectors. One is a constant vector containing all ones and the other is the vector with components $\exp(-t)$. The unknown coefficients, c_1 and c_2 , can be computed by doing a least-squares fit, which minimizes the sum of the squares of the deviations of the data from the model. There are six equations and two unknowns, represented by a 6-by-2 matrix.

```
E = [ones(size(t)) exp(-t)]
```

```
E = 6×2
```

```
 1.0000    1.0000
 1.0000    0.7408
 1.0000    0.4493
 1.0000    0.3329
 1.0000    0.2019
 1.0000    0.1003
```

Use the `fixed.qrMatrixSolve` function to get the least-squares solution.

```
c = fixed.qrMatrixSolve(E, y)
```

```
c = 2×1
```

```
 0.4760
 0.3413
```

In other words, the least-squares fit to the data is

$$y(t) = 0.4760 + 0.3413e^{-t}.$$

The following statements evaluate the model at regularly spaced increments in t , and then plot the result together with the original data:

```
T = (0:0.1:2.5)';
Y = [ones(size(T)) exp(-T)]*c;
plot(T,Y,'-',t,y,'o')
```

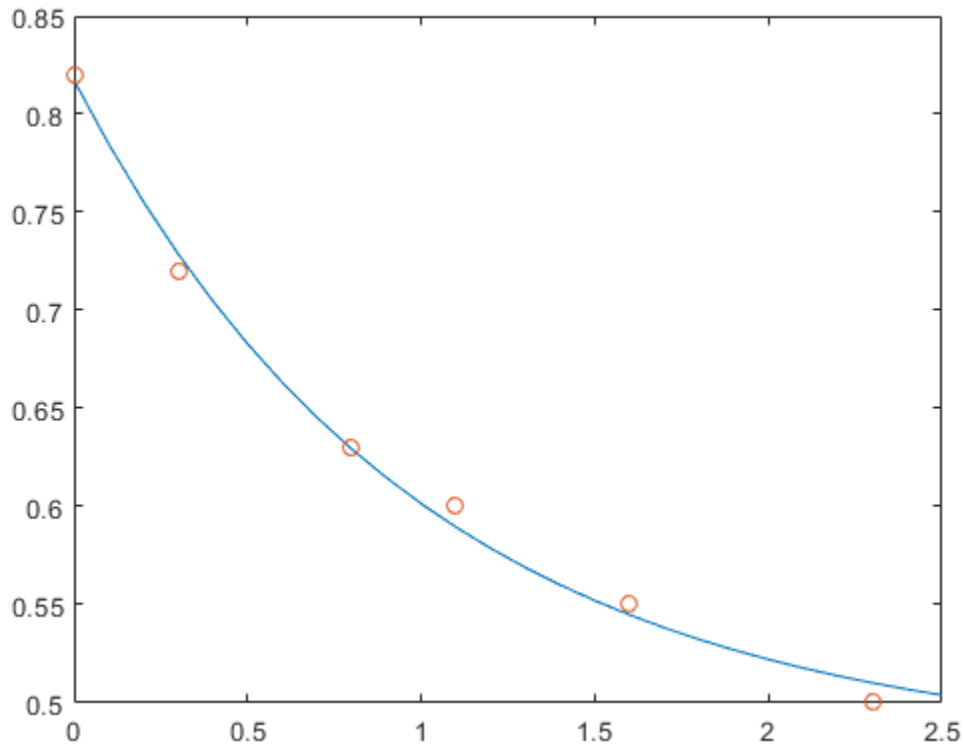

In cases where the input matrices are ill-conditioned, small positive values of a regularization parameter can improve the conditioning of the least squares problem, and reduce the variance of the estimates. Explore the effect of the regularization parameter on the least squares solution for this data.

```
figure;
lambda = [0:0.1:0.5];
plot(t,y,'o', 'DisplayName', 'Original Data');
for i = 1:length(lambda)
    c = fixed.qrMatrixSolve(E, y, numerictype('double'), lambda(i));
    Y = [ones(size(T)) exp(-T)]*c;
    hold on
    plot(T,Y,'-', 'DisplayName', ['lambda = ', num2str(lambda(i))])
end
legend('Original Data', 'lambda = 0', 'lambda = 0.1', 'lambda = 0.2', 'lambda = 0.3', 'lambda = 0.5')
```

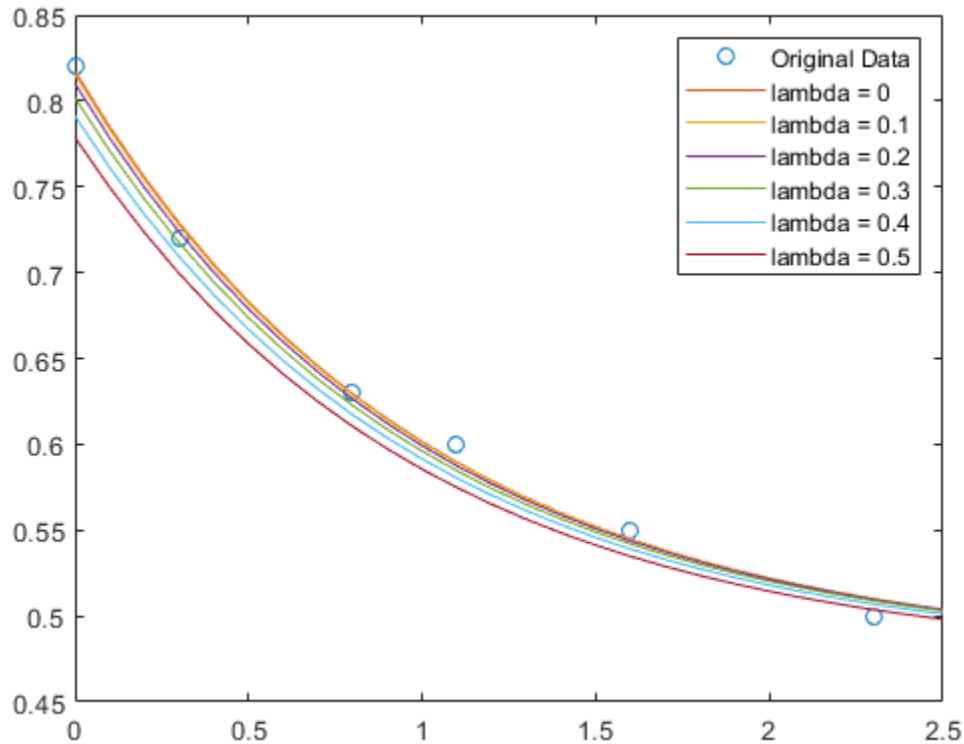

Input Arguments

A — Coefficient matrix

matrix

Coefficient matrix in the linear system of equations $Ax = B$.

Data Types: `single` | `double` | `fi`

Complex Number Support: Yes

B — Input array

vector | matrix

Input vector or matrix representing B in the linear system of equations $Ax = B$.

Data Types: `single` | `double` | `fi`

Complex Number Support: Yes

outputType — Output data type

numericType object | numeric variable

Output data type, specified as a `numericType` object or a numeric variable. If `outputType` is specified as a `numericType` object, the output, x , will have the specified data type. If `outputType` is specified as a numeric variable, x will have the same data type as the numeric variable.

Data Types: `single` | `double` | `int8` | `int16` | `int32` | `int64` | `uint8` | `uint16` | `uint32` | `uint64` | `logical` | `fi` | `numericType`

regularizationParameter — Regularization parameter

nonnegative scalar

Regularization parameter, specified as a non-negative scalar. Small, positive values of the regularization parameter can improve the conditioning of the problem and reduce the variance of the estimates. While biased, the reduced variance of the estimate often results in a smaller mean squared error when compared to least-squares estimates.

Data Types: `single` | `double` | `int8` | `int16` | `int32` | `int64` | `uint8` | `uint16` | `uint32` | `uint64` | `fi`

Output Arguments

x — Solution

vector | matrix

Solution, returned as a vector or matrix. If A is an m -by- n matrix and B is an m -by- p matrix, then x is an n -by- p matrix.

Extended Capabilities

C/C++ Code Generation

Generate C and C++ code using MATLAB® Coder™.

Generate code for double-precision, single-precision, and fixed-point data types.

Fixed-Point Conversion

Design and simulate fixed-point systems using Fixed-Point Designer™.

A and B must be signed and use binary-point scaling. Slope-bias representation is not supported for fixed-point data types.

See Also

`fixed.backwardSubstitute` | `fixed.forwardSubstitute` | `fixed.qlessQR` | `fixed.qlessQRMatrixSolve` | `fixed.qlessQRUpdate` | `fixed.qrAB`

Introduced in R2020b

fixed.Quantizer

Quantize fixed-point numbers

Syntax

```
q = fixed.Quantizer
q = fixed.Quantizer(nt,rm,oa)
q = fixed.Quantizer(s,wl,fl,rm,oa)
q = fixed.Quantizer(Name,Value)
```

Description

`q = fixed.Quantizer` creates a quantizer `q` that quantizes fixed-point (`fi`) numbers using default fixed-point settings.

`q = fixed.Quantizer(nt,rm,oa)` uses the `numericType` (`nt`) object information and the `RoundingMethod` (`rm`) and `OverflowAction` (`oa`) properties.

The `numericType`, rounding method, and overflow action apply only during the quantization. The resulting, quantized `q` does not have any `fi` attached to it.

`q = fixed.Quantizer(s,wl,fl,rm,oa)` uses the `Signed` (`s`), `WordLength` (`wl`), `FractionLength` (`fl`), `RoundingMethod` (`rm`), and `OverflowAction` (`oa`) properties.

`q = fixed.Quantizer(Name,Value)` creates a quantizer with the property options specified by one or more `Name, Value` pair arguments. You separate pairs of `Name, Value` arguments with commas. `Name` is the argument name, and `Value` is the corresponding value. `Name` must appear inside single quotes (' '). You can specify several name-value pair arguments in any order as `Name1, Value1, ..., NameN, ValueN`.

Input Arguments

nt

Binary-point, scaled `numericType` object or slope-bias scaled, fixed-point `numericType` object. If your `fixed.Quantizer` uses a `numericType` object that has either a `Signedness` of `Auto` or unspecified `Scaling`, an error occurs.

rm

Rounding method to apply to the output data. Valid rounding methods are: `Ceiling`, `Convergent`, `Floor`, `Nearest`, `Round`, and `Zero`. The associated property name is `RoundingMethod`.

Default: `Floor`

oa

Overflow action to take in case of data overflow. Valid overflow actions are `Saturate` and `Wrap`. The associated property name is `OverflowAction`.

Default: `Wrap`

s

Logical value, `true` or `false`, indicating whether the output is signed or unsigned, respectively. The associated property name is `Signed`.

Default: `true`

wl

Word length (number of bits) of the output data. The associated property name is `WordLength`.

Default: 16

fl

Fraction length of the output data. The associated property name is `FractionLength`.

Default: 15

Name-Value Pair Arguments

Specify optional comma-separated pairs of `Name`, `Value` arguments. `Name` is the argument name and `Value` is the corresponding value. `Name` must appear inside quotes. You can specify several name and value pair arguments in any order as `Name1, Value1, . . . , NameN, ValueN`.

Bias

The bias is part of the numerical representation used to interpret a fixed-point number on page 4-426. Along with the slope, the bias forms the scaling of the number.

Default: 0

FixedExponent

Fixed-point exponent associated with the object. The exponent is part of the numerical representation used to express a fixed-point number on page 4-426.

The exponent of a fixed-point number is equal to the negative of the fraction length. `FixedExponent` must be an integer.

Default: -15

FractionLength

Fraction length of the stored integer value of the object, in bits. The fraction length can be any integer value.

This property automatically defaults to the best precision possible based on the value of the word length and the real-world value of the `fi` object.

Default: 15

OverflowAction

Action to take in case of data overflow. Valid overflow actions are `Saturate` and `Wrap`.

Default: Wrap

RoundingMethod

Rounding method to apply to the output data. Valid rounding methods are: Ceiling, Convergent, Floor, Nearest, Round, and Zero.

Default: Floor

Signed

Whether the object is signed. The possible values of this property are:

- 1 — signed
- 0 — unsigned
- true — signed
- false — unsigned

Note Although the Signed property is still supported, the Signedness property always appears in the numeric type object display. If you choose to change or set the signedness of your numeric type object using the Signed property, MATLAB updates the corresponding value of the Signedness property.

Default: true

Signedness

Whether the object is signed, unsigned, or has an unspecified sign. The possible values of this property are:

- Signed — signed
- Unsigned — unsigned

Default: Signed

Slope

Slope associated with the object. The slope is part of the numerical representation used to express a fixed-point number on page 4-426. Along with the bias, the slope forms the scaling of a fixed-point number.

Default: 2^{-15}

SlopeAdjustmentFactor

Slope adjustment associated with the object. The slope adjustment is equivalent to the fractional slope of a fixed-point number. The fractional slope is part of the numerical representation used to express a fixed-point number.

SlopeAdjustmentFactor must be greater than or equal to 1 and less than 2.

Default: 1

WordLength

Word length of the stored integer value of the object, in bits. The word length can be any positive integer value.

Default: 16

Output Arguments

q

Quantizer that quantizes `fi` input numbers

Examples

Use `fixed.Quantizer` to reduce the word length that results from adding two fixed-point numbers.

```
q = fixed.Quantizer;
x1 = fi(0.1,1,16,15);
x2 = fi(0.8,1,16,15);
y = quantize(q,x1+x2);
```

Use `fixed.Quantizer` object to change a binary point scaled fixed-point `fi` to a slope-bias scaled fixed-point `fi`

```
qsb = fixed.Quantizer(numericType(1,7,1.6,0.2),...
    'Round','Saturate');
ysb = quantize(qsb,fi(pi,1,16,13));
```

More About

Fixed-point numbers

Fixed-point numbers can be represented as

$$\text{real-worldvalue} = (\text{slope} \times \text{storedinteger}) + \text{bias}$$

where the slope can be expressed as

$$\text{slope} = \text{fractionalslope} \times 2^{\text{fixedexponent}}$$

Tips

- Use `y = quantize(q,x)` to quantize input array `x` using the fixed-point settings of quantizer `q`. `x` can be any fixed-point number `fi`, except a Boolean value. If `x` is a scaled double, the `x` and `y` data will be the same, but `y` will have fixed-point settings. If `x` is a double or single then `y = x`. This functionality lets you share the same code for both floating-point data types and `fi` objects when quantizers are present.
- Use `n = numericType(q)` to get a `numericType` for the current settings of quantizer `q`.
- Use `clone(q)` to create a quantizer object with the same property values as `q`.
- If you use a `fixed.quantizer` in code generation, note that it is a handle object and must be declared as persistent.

Extended Capabilities

C/C++ Code Generation

Generate C and C++ code using MATLAB® Coder™.

See Also

`fi` | `numericType` | `quantizer`

Topics

“Set numericType Object Properties”

Introduced in R2011b

fixpt_instrument_purge

Remove corrupt fixed-point instrumentation from model

Compatibility

Note `fixpt_instrument_purge` will be removed in a future release.

Syntax

```
fixpt_instrument_purge  
fixpt_instrument_purge(modelName, interactive)
```

Description

The `fixpt_instrument_purge` script finds and removes fixed-point instrumentation from a model left by the Fixed-Point Tool and the fixed-point autoscaling script. The Fixed-Point Tool and the fixed-point autoscaling script each add callbacks to a model. For example, the Fixed-Point Tool appends commands to model-level callbacks. These callbacks make the Fixed-Point Tool respond to simulation events. Similarly, the autoscaling script adds instrumentation to some parameter values that gathers information required by the script.

Normally, these types of instrumentation are automatically removed from a model. The Fixed-Point Tool removes its instrumentation when the model is closed. The autoscaling script removes its instrumentation shortly after it is added. However, there are cases where abnormal termination of a model leaves fixed-point instrumentation behind. The purpose of `fixpt_instrument_purge` is to find and remove fixed-point instrumentation left over from abnormal termination.

`fixpt_instrument_purge(modelName, interactive)` removes instrumentation from model `modelName`. `interactive` is `true` by default, which prompts you to make each change. When `interactive` is set to `false`, all found instrumentation is automatically removed from the model.

See Also

`autofixexp` | `fxptdlg`

Introduced before R2006a

floor

Round toward negative infinity

Syntax

```
y = floor(a)
```

Description

`y = floor(a)` rounds `fi` object `a` to the nearest integer in the direction of negative infinity and returns the result in `fi` object `y`.

Examples

Use floor on a Signed `fi` Object

The following example demonstrates how the `floor` function affects the `numericType` properties of a signed `fi` object with a word length of 8 and a fraction length of 3.

```
a = fi(pi,1,8,3)
```

```
a =
    3.1250
```

```
    DataTypeMode: Fixed-point: binary point scaling
    Signedness: Signed
    WordLength: 8
    FractionLength: 3
```

```
y = floor(a)
```

```
y =
    3
```

```
    DataTypeMode: Fixed-point: binary point scaling
    Signedness: Signed
    WordLength: 5
    FractionLength: 0
```

The following example demonstrates how the `floor` function affects the `numericType` properties of a signed `fi` object with a word length of 8 and a fraction length of 12.

```
a = fi(0.025,1,8,12)
```

```
a =
    0.0249
```

```
    DataTypeMode: Fixed-point: binary point scaling
    Signedness: Signed
    WordLength: 8
    FractionLength: 12
```

```
y = floor(a)
```

```
y =
    0
```

```
DataTypeMode: Fixed-point: binary point scaling
Signedness: Signed
WordLength: 2
FractionLength: 0
```

Compare Rounding Methods

The functions `ceil`, `fix`, and `floor` differ in the way they round `fi` objects:

- The `ceil` function rounds values to the nearest integer toward positive infinity.
- The `fix` function rounds values to the nearest integer toward zero.
- The `floor` function rounds values to the nearest integer toward negative infinity.

This example illustrates these differences for a given `fi` input object `a`.

```
a = fi([-2.5,-1.75,-1.25,-0.5,0.5,1.25,1.75,2.5]');
y = [a ceil(a) fix(a) floor(a)]
```

```
y=8x4 object
-2.5000 -2.0000 -2.0000 -3.0000
-1.7500 -1.0000 -1.0000 -2.0000
-1.2500 -1.0000 -1.0000 -2.0000
-0.5000 0 0 -1.0000
0.5000 1.0000 0 0
1.2500 2.0000 1.0000 1.0000
1.7500 2.0000 1.0000 1.0000
2.5000 3.0000 2.0000 2.0000
```

```
DataTypeMode: Fixed-point: binary point scaling
Signedness: Signed
WordLength: 16
FractionLength: 13
```

```
plot(a,y); legend('a','ceil(a)','fix(a)','floor(a)','location','NW');
```

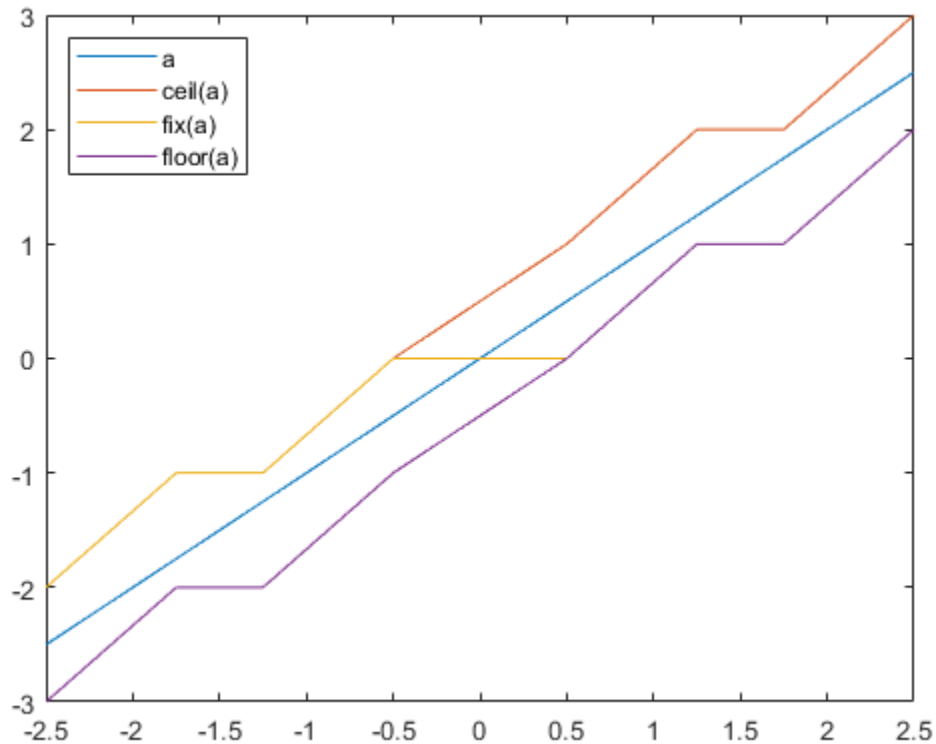
Input Arguments

a — Input `fi` array

scalar | vector | matrix | multidimensional array

Input `fi` array, specified as scalar, vector, matrix, or multidimensional array.

For complex `fi` objects, the imaginary and real parts are rounded independently.

`floor` does not support `fi` objects with nontrivial slope and bias scaling. Slope and bias scaling is trivial when the slope is an integer power of 2 and the bias is 0.

Data Types: `fi`

Complex Number Support: Yes

Algorithms

- `y` and `a` have the same `fi` object and `DataType` property.
- When the `DataType` property of `a` is `single`, `double`, or `boolean`, the `numericType` of `y` is the same as that of `a`.
- When the fraction length of `a` is zero or negative, `a` is already an integer, and the `numericType` of `y` is the same as that of `a`.

- When the fraction length of a is positive, the fraction length of y is 0, its sign is the same as that of a , and its word length is the difference between the word length and the fraction length of a , plus one bit. If a is signed, then the minimum word length of y is 2. If a is unsigned, then the minimum word length of y is 1.

Extended Capabilities

C/C++ Code Generation

Generate C and C++ code using MATLAB® Coder™.

HDL Code Generation

Generate Verilog and VHDL code for FPGA and ASIC designs using HDL Coder™.

See Also

`ceil` | `convergent` | `fix` | `nearest` | `round`

Introduced in R2008a

floorDiv

Round the result of division toward negative infinity

Syntax

```
y = floorDiv(x,d)
y = floorDiv(x,d,m)
```

Description

`y = floorDiv(x,d)` returns the result of x/d rounded to the nearest integer value in the direction of negative infinity.

`y = floorDiv(x,d,m)` returns the result of x/d rounded to the nearest multiple of m in the direction of negative infinity.

The datatype of y is calculated such that the wordlength and fraction length are of a sufficient size to contain both the largest and smallest possible solutions given the data type of x , and the values of d and m .

Examples

Divide and Round to Floor

Perform a division operation and round to the nearest integer value in the direction of negative infinity.

```
floorDiv(int16(201),10)
```

```
ans =
```

```
    20
```

```
    DataTypeMode: Fixed-point: binary point scaling
    Signedness: Signed
    WordLength: 14
    FractionLength: 0
```

Perform a division operation and round to the nearest multiple of 7 in the direction of negative infinity.

```
floorDiv(int16(201),10,7)
```

```
ans =
```

```
    14
```

```
    DataTypeMode: Fixed-point: binary point scaling
    Signedness: Signed
```

WordLength: 14
FractionLength: 0

Input Arguments

x — Dividend

scalar

Dividend, specified as a scalar.

Data Types: `single` | `double` | `int8` | `int16` | `int32` | `int64` | `uint8` | `uint16` | `uint32` | `uint64` | `logical` | `fi`

d — Divisor

scalar

Divisor, specified as a scalar.

Data Types: `single` | `double` | `int8` | `int16` | `int32` | `int64` | `uint8` | `uint16` | `uint32` | `uint64` | `logical` | `fi`

m — Value to round to nearest multiple of

1 (default) | scalar

Value to round to nearest multiple of, specified as a scalar.

Data Types: `single` | `double` | `int8` | `int16` | `int32` | `int64` | `uint8` | `uint16` | `uint32` | `uint64` | `logical` | `fi`

Output Arguments

y — Result of division and round to floor

scalar

Result of division and round to floor, returned as a scalar.

The datatype of `y` is calculated such that the wordlength and fraction length are of a sufficient size to contain both the largest and smallest possible solutions given the data type of `x`, and the values of `d` and `m`.

Extended Capabilities

C/C++ Code Generation

Generate C and C++ code using MATLAB® Coder™.

Slope-bias representation is not supported for fixed-point data types.

Fixed-Point Conversion

Design and simulate fixed-point systems using Fixed-Point Designer™.

Slope-bias representation is not supported for fixed-point data types.

See Also

`ceilDiv` | `fixDiv` | `nearestDiv`

Introduced in R2021a

fma

Multiply and add using fused multiply add approach

Syntax

```
X = fma(A, B, C)
```

Description

`X = fma(A, B, C)` computes $A \cdot B + C$ using a fused multiply add approach. Fused multiply add operations round only once, often making the result more accurate than performing a multiplication operation followed by an addition.

Examples

Multiply and Add Three Inputs Using Fused Multiply Add

This example shows how to use the `fma` function to calculate $A \times B + C$ using a fused multiply add approach.

Define the inputs and use the `fma` function to compute the multiply add operation.

```
a = half(10);  
b = half(10);  
c = half(2);  
x = fma(a, b, c)
```

```
x =
```

```
half
```

```
102
```

Compare the result of the `fma` function with the two-step approach of computing the product and then the sum.

```
temp = a * b;  
x = temp + c
```

```
x =
```

```
half
```

```
102
```

Input Arguments

A — Input array

scalar | vector | matrix | multidimensional array

Input array, specified as a floating-point scalar, vector, matrix, or multidimensional array. When A and B are matrices, `fma` performs element-wise multiplication followed by addition.

Data Types: `single` | `double` | `half`

B — Input array

scalar | vector | matrix | multidimensional array

Input array, specified as a floating-point scalar, vector, matrix, or multidimensional array. When A and B are matrices, `fma` performs element-wise multiplication followed by addition.

Data Types: `single` | `double` | `half`

C — Input array

scalar | vector | matrix | multidimensional array

Input array, specified as a floating-point scalar, vector, matrix, or multidimensional array.

Data Types: `single` | `double` | `half`

Output Arguments

X — Result of multiply and add operation

scalar | vector | matrix | multidimensional array

Result of multiply and add operation, $A.*B+C$, returned as a scalar, vector, matrix, or multidimensional array.

See Also

`half`

Introduced in R2019a

for

Execute statements specified number of times

Syntax

```
for index = values  
    statements  
end
```

Description

`for index = valuesstatements, end` executes a group of statements in a loop for a specified number of times.

If a colon, `:` operation with `fi` objects is used as the index, then the `fi` objects must be whole numbers.

Refer to the MATLAB for reference page for more information.

Example

Use `fi` in a For Loop

Use a `fi` object as the index of a for-loop.

```
a = fi(1,0,8,0);  
b = fi(2,0,8,0);  
c = fi(10,0,8,0);
```

```
for x = a:b:c  
    x  
end
```

Extended Capabilities

C/C++ Code Generation

Generate C and C++ code using MATLAB® Coder™.

Introduced in R2014b

fractionlength

Fraction length of quantizer object

Syntax

```
fractionlength(q)
```

Description

`fractionlength(q)` returns the fraction length of quantizer object `q`.

Algorithms

For floating-point quantizer objects, $f = w - e - 1$, where w is the word length and e is the exponent length.

For fixed-point quantizer objects, f is part of the format $[w f]$.

See Also

`fi` | `numericType` | `quantizer` | `wordlength`

Introduced before R2006a

fxpopt

Optimize data types of a system

Syntax

```
result = fxpopt(model, sud, options)
```

Description

`result = fxpopt(model, sud, options)` optimizes the data types in the model or subsystem specified by `sud` in the model, `model`, with additional options specified in the `fxpOptimizationOptions` object, `options`.

Examples

Optimize Fixed-Point Data Types

This example shows how to optimize the data types used by a system based on specified tolerances.

To begin, open the system for which you want to optimize the data types.

```
model = 'ex_auto_gain_controller';
sud = 'ex_auto_gain_controller/sud';
open_system(model)
```

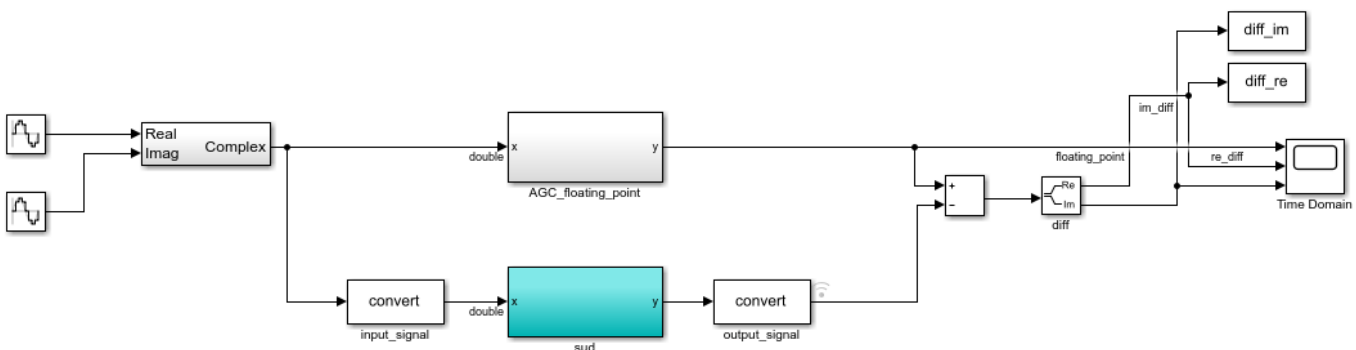

Copyright 2017 The MathWorks, Inc.

Create an `fxpOptimizationOptions` object to define constraints and tolerances to meet your design goals. Set the `UseParallel` property of the `fxpOptimizationOptions` object to `true` to run iterations of the optimization in parallel. You can also specify word lengths to allow in your design through the `AllowableWordLengths` property.

```
opt = fxpOptimizationOptions('AllowableWordLengths', 10:24, 'UseParallel', true)
```

```

opt =
    fxpOptimizationOptions with properties:
        MaxIterations: 50
        MaxTime: 600
        Patience: 10
        Verbosity: High
    AllowableWordLengths: [10 11 12 13 14 15 16 17 18 19 20 21 22 23 24]
    UseParallel: 1

    Advanced Options
        AdvancedOptions: [1x1 struct]

```

Use the `addTolerance` method to define tolerances for the differences between the original behavior of the system, and the behavior using the optimized fixed-point data types.

```

tol = 10e-2;
addTolerance(opt, [model '/output_signal'], 1, 'AbsTol', tol);

```

Use the `fxpopt` function to run the optimization. The software analyzes ranges of objects in your system under design and the constraints specified in the `fxpOptimizationOptions` object to apply heterogeneous data types to your system while minimizing total bit width.

```

result = fxpopt(model, sud, opt);

```

```

Starting parallel pool (parpool) using the 'local' profile ...
Connected to the parallel pool (number of workers: 4).
+ Preprocessing
+ Modeling the optimization problem
  - Constructing decision variables
+ Running the optimization solver
Analyzing and transferring files to the workers ...done.
- Evaluating new solution: cost 180, does not meet the tolerances.
- Evaluating new solution: cost 198, does not meet the tolerances.
- Evaluating new solution: cost 216, does not meet the tolerances.
- Evaluating new solution: cost 234, does not meet the tolerances.
- Evaluating new solution: cost 252, does not meet the tolerances.
- Evaluating new solution: cost 270, does not meet the tolerances.
- Evaluating new solution: cost 288, does not meet the tolerances.
- Evaluating new solution: cost 306, meets the tolerances.
- Evaluating new solution: cost 324, meets the tolerances.
- Evaluating new solution: cost 342, meets the tolerances.
- Evaluating new solution: cost 360, meets the tolerances.
- Evaluating new solution: cost 378, meets the tolerances.
- Evaluating new solution: cost 396, meets the tolerances.
- Evaluating new solution: cost 414, meets the tolerances.
- Evaluating new solution: cost 432, meets the tolerances.
- Updated best found solution, cost: 306
- Evaluating new solution: cost 304, meets the tolerances.
- Evaluating new solution: cost 304, meets the tolerances.
- Evaluating new solution: cost 301, meets the tolerances.
- Evaluating new solution: cost 305, does not meet the tolerances.
- Evaluating new solution: cost 305, meets the tolerances.
- Evaluating new solution: cost 301, meets the tolerances.
- Evaluating new solution: cost 299, meets the tolerances.

```

- Evaluating new solution: cost 299, meets the tolerances.
- Evaluating new solution: cost 296, meets the tolerances.
- Evaluating new solution: cost 299, meets the tolerances.
- Evaluating new solution: cost 291, meets the tolerances.
- Evaluating new solution: cost 296, does not meet the tolerances.
- Evaluating new solution: cost 299, meets the tolerances.
- Evaluating new solution: cost 300, meets the tolerances.
- Evaluating new solution: cost 296, does not meet the tolerances.
- Evaluating new solution: cost 301, meets the tolerances.
- Evaluating new solution: cost 303, meets the tolerances.
- Evaluating new solution: cost 299, meets the tolerances.
- Evaluating new solution: cost 304, does not meet the tolerances.
- Evaluating new solution: cost 300, meets the tolerances.
- Updated best found solution, cost: 304
- Updated best found solution, cost: 301
- Updated best found solution, cost: 299
- Updated best found solution, cost: 296
- Updated best found solution, cost: 291
- Evaluating new solution: cost 280, meets the tolerances.
- Evaluating new solution: cost 287, meets the tolerances.
- Evaluating new solution: cost 288, does not meet the tolerances.
- Evaluating new solution: cost 287, does not meet the tolerances.
- Evaluating new solution: cost 283, meets the tolerances.
- Evaluating new solution: cost 283, does not meet the tolerances.
- Evaluating new solution: cost 262, does not meet the tolerances.
- Evaluating new solution: cost 283, does not meet the tolerances.
- Evaluating new solution: cost 282, does not meet the tolerances.
- Evaluating new solution: cost 288, meets the tolerances.
- Evaluating new solution: cost 289, meets the tolerances.
- Evaluating new solution: cost 288, meets the tolerances.
- Evaluating new solution: cost 290, meets the tolerances.
- Evaluating new solution: cost 281, does not meet the tolerances.
- Evaluating new solution: cost 286, does not meet the tolerances.
- Evaluating new solution: cost 287, meets the tolerances.
- Evaluating new solution: cost 284, meets the tolerances.
- Evaluating new solution: cost 282, meets the tolerances.
- Evaluating new solution: cost 285, does not meet the tolerances.
- Evaluating new solution: cost 277, meets the tolerances.
- Updated best found solution, cost: 280
- Updated best found solution, cost: 277
- Evaluating new solution: cost 272, meets the tolerances.
- Evaluating new solution: cost 266, meets the tolerances.
- Evaluating new solution: cost 269, meets the tolerances.
- Evaluating new solution: cost 271, does not meet the tolerances.
- Evaluating new solution: cost 274, meets the tolerances.
- Evaluating new solution: cost 275, meets the tolerances.
- Evaluating new solution: cost 274, does not meet the tolerances.
- Evaluating new solution: cost 275, meets the tolerances.
- Evaluating new solution: cost 276, does not meet the tolerances.
- Evaluating new solution: cost 271, meets the tolerances.
- Evaluating new solution: cost 267, meets the tolerances.
- Evaluating new solution: cost 270, meets the tolerances.
- Evaluating new solution: cost 272, meets the tolerances.
- Evaluating new solution: cost 264, does not meet the tolerances.
- Evaluating new solution: cost 265, does not meet the tolerances.
- Evaluating new solution: cost 269, meets the tolerances.
- Evaluating new solution: cost 270, meets the tolerances.
- Evaluating new solution: cost 269, meets the tolerances.

- Evaluating new solution: cost 276, meets the tolerances.
- Evaluating new solution: cost 274, meets the tolerances.
- Updated best found solution, cost: 272
- Updated best found solution, cost: 266
- + Optimization has finished.
 - Neighborhood search complete.
 - Maximum number of iterations completed.
- + Fixed-point implementation that met the tolerances found.
 - Total cost: 266
 - Maximum absolute difference: 0.087035
 - Use the explore method of the result to explore the implementation.

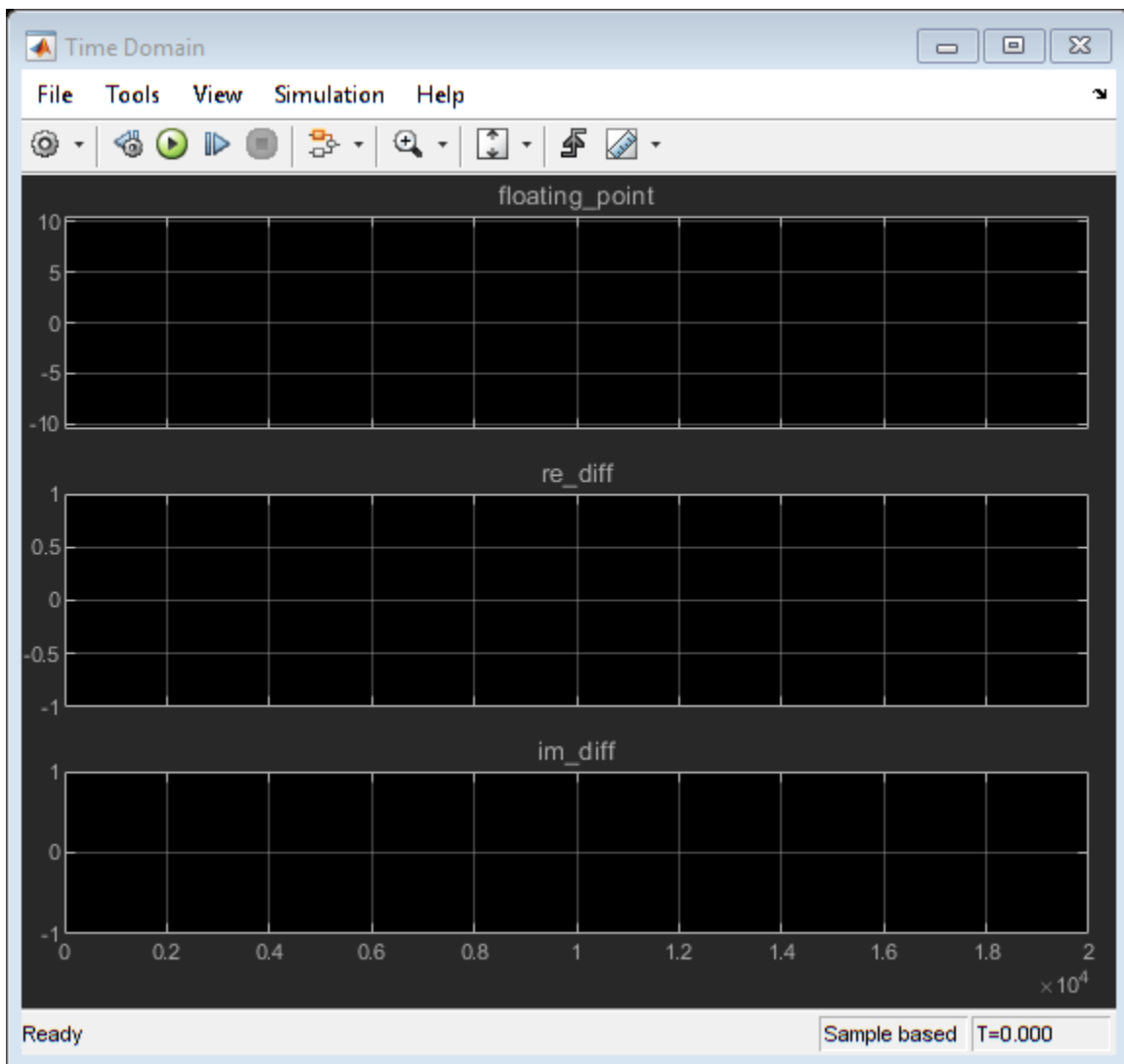

Use the `explore` method of the `OptimizationResult` object, `result`, to launch Simulation Data Inspector and explore the design containing the smallest total number of bits while maintaining the numeric tolerances specified in the `opt` object.

```
explore(result);
```

You can revert your model back to its original state using the `revert` method of the `OptimizationResult` object.

```
revert(result);
```

Input Arguments

model — Model containing system under design, sud

character vector

Name of the model containing the system that you want to optimize.

Data Types: char

sud — Model or subsystem whose data types you want to optimize

character vector

Model or subsystem whose data types you want to optimize, specified as a character vector containing the path to the system.

Data Types: char

options — Additional optimization options

`fxpOptimizationOptions` object

`fxpOptimizationOptions` object specifying additional options to use during the data type optimization process.

Output Arguments

result — Object containing the optimized design

`OptimizationResult` object

Result of the optimization, returned as an `OptimizationResult` object. Use the `explore` method of the object to open the Simulation Data Inspector and view the behavior of the optimized system. You can also explore other solutions found during the optimization that may or may not meet the constraints specified in the `fxpOptimizationOptions` object, `options`.

See Also

Classes

`OptimizationResult` | `OptimizationSolution` | `fxpOptimizationOptions`

Functions

`addTolerance` | `explore` | `showTolerances`

Topics

“Optimize Fixed-Point Data Types for a System”

Introduced in R2018a

fxptdlg

Start Fixed-Point Tool

Syntax

```
fxptdlg('modelName')
```

Description

`fxptdlg('modelName')` starts the Fixed-Point Tool for the Simulink model specified by `modelName`. You can also access this tool by the following methods:

- From the **Apps** tab, under **Code Generation** click **Fixed-Point Tool**.
- From a subsystem context (right-click) menu, select **Fixed-Point Tool**.

In conjunction with Fixed-Point Designer software, the Fixed-Point Tool provides convenient access to:

- Model and subsystem parameters that control the signal logging, fixed-point instrumentation mode, and data type override.
- Plotting capabilities that enable you to plot data that resides in the MATLAB workspace, namely, simulation results associated with Scope, To Workspace, and root-level Outport blocks, in addition to logged signal data (see “Signal Logging” in the *Simulink User's Guide*)
- An interactive automatic data typing feature that proposes fixed-point data types for appropriately configured objects in your model, and then allows you to selectively accept and apply the data type proposals

You can launch the Fixed-Point Tool for any system or subsystem, and the tool controls the object selected in its **System under design** pane. If Fixed-Point Designer software is installed, the Fixed-Point Tool displays the name, data type, design minimum and maximum values, minimum and maximum simulation values, and scaling of each model object that logs fixed-point data. Additionally, if a signal saturates or overflows, the tool displays the number of times saturation or overflow occurred.

Note If your model uses accelerator or rapid accelerator simulation modes, the Fixed-Point Tool changes the simulation mode to normal during range collection, and then sets it back to its original simulation mode once the range collection simulation is complete.

Overriding Fixed-Point Specifications

Most of the functionality in the Fixed-Point Tool is for use with the Fixed-Point Designer software. However, even if you do not have Fixed-Point Designer software, you can configure data type override settings to simulate a model that specifies fixed-point data types. In this mode, the Simulink software temporarily overrides fixed-point data types with floating-point data types when simulating the model.

Note If you use `fi` on page 4-349 objects or embedded numeric data types in your model or workspace, you might introduce fixed-point data types into your model. You can set `fipref` on page 4-349 to prevent the checkout of a Fixed-Point Designer license.

To simulate a model without using Fixed-Point Designer:

- 1 Enter the following at the command line.

```
set_param(gcs, 'DataTypeOverride', 'Double', ...  
          'DataTypeOverrideAppliesTo', 'AllNumericTypes', ...  
          'MinMaxOverflowLogging', 'ForceOff')
```

- 2 If you use `fi` objects or embedded numeric data types in your model, set the `fipref` `DataTypeOverride` property to `TrueDoubles` or `TrueSingles` (to be consistent with the model-wide data type override setting) and the `DataTypeOverrideAppliesTo` property to `All numeric types`.

For example, at the MATLAB command line, enter:

```
p = fipref('DataTypeOverride', 'TrueDoubles', ...  
          'DataTypeOverrideAppliesTo', 'AllNumericTypes');
```

See Also

“Propose Fraction Lengths Using Simulation Range Data” | Fixed-Point Tool

Introduced before R2006a

ge

Determine whether real-world value of one `fi` object is greater than or equal to another

Syntax

```
c = ge(a,b)
a >= b
```

Description

`c = ge(a, b)` is called for the syntax `a >= b` when `a` or `b` is a `fi` object. `a` and `b` must have the same dimensions unless one is a scalar. A scalar can be compared with another object of any size.

`a >= b` does an element-by-element comparison between `a` and `b` and returns a matrix of the same size with elements set to 1 where the relation is true, and 0 where the relation is false.

In relational operations comparing a floating-point value to a fixed-point value, the floating-point value is cast to the same word length and signedness as the `fi` object, with best-precision scaling.

Examples

Compare Two `fi` Objects

Use the `ge` function to determine whether the real-world value of one `fi` object is greater than or equal to another.

```
a = fi(pi);
b = fi(pi, 1, 32);
b >= a
```

```
ans = logical
      0
```

Input `a` has a 16-bit word length, while input `b` has a 32-bit word length. The `ge` function returns 0 because after quantization, the value of `a` is slightly greater than that of `b`.

Compare a Double to a `fi` Object

When comparing a double to a `fi` object, the double is cast to the same word length and signedness of the `fi` object.

```
a = fi(pi);
b = pi;
a >= b
```

```
ans = logical  
     1
```

The `ge` function casts `b` to the same word length as `a`, and returns `1` because the two inputs have the same real-world value. This behavior allows relational operations to work between `fi` objects and floating-point constants without introducing floating-point values in generated code.

Extended Capabilities

C/C++ Code Generation

Generate C and C++ code using MATLAB® Coder™.

Usage notes and limitations:

- Fixed-point signals with different biases are not supported.

HDL Code Generation

Generate Verilog and VHDL code for FPGA and ASIC designs using HDL Coder™.

See Also

`eq` | `gt` | `le` | `lt` | `ne`

Introduced before R2006a

get

Property values of object

Syntax

```
value = get(o, 'propertyname')  
structure = get(o)
```

Description

`value = get(o, 'propertyname')` returns the property value of the property 'propertyname' for the object `o`. If you replace 'propertyname' by a cell array of a vector of strings containing property names, `get` returns a cell array of a vector of corresponding values.

`structure = get(o)` returns a structure containing the properties and states of object `o`.

`o` can be a `fi`, `fimath`, `fipref`, `numericType`, or `quantizer` object.

Extended Capabilities

C/C++ Code Generation

Generate C and C++ code using MATLAB® Coder™.

Usage notes and limitations:

- The syntax `structure = get(o)` is not supported.

See Also

`set`

Introduced before R2006a

getlsb

Least significant bit

Syntax

```
c = getlsb(a)
```

Description

`c = getlsb(a)` returns the value of the least significant bit in `a` as a `u1,0`.

`a` can be a scalar `fi` object or a vector `fi` object.

`getlsb` only supports `fi` objects with fixed-point data types.

Examples

The following example uses `getlsb` to find the least significant bit in the `fi` object `a`.

```
a = fi(-26, 1, 6, 0);  
c = getlsb(a)
```

```
c =
```

```
    0
```

```
      DataTypeMode: Fixed-point: binary point scaling  
      Signedness: Unsigned  
      WordLength: 1  
      FractionLength: 0
```

You can verify that the least significant bit in the `fi` object `a` is `0` by looking at the binary representation of `a`.

```
disp(bin(a))
```

```
100110
```

Extended Capabilities

C/C++ Code Generation

Generate C and C++ code using MATLAB® Coder™.

HDL Code Generation

Generate Verilog and VHDL code for FPGA and ASIC designs using HDL Coder™.

See Also

`bitand` | `bitandreduce` | `bitconcat` | `bitget` | `bitor` | `bitorreduce` | `bitset` | `bitxor` | `bitxorreduce` | `getmsb`

Introduced in R2007b

getmsb

Most significant bit

Syntax

```
c = getmsb(a)
```

Description

`c = getmsb(a)` returns the value of the most significant bit in `a` as a `u1,0`.

`a` can be a scalar `fi` object or a vector `fi` object.

`getmsb` only supports `fi` objects with fixed-point data types.

Examples

The following example uses `getmsb` to find the most significant bit in the `fi` object `a`.

```
a = fi(-26, 1, 6, 0);
c = getmsb(a)

c =

     1

      DataTypeMode: Fixed-point: binary point scaling
      Signedness: Unsigned
      WordLength: 1
      FractionLength: 0
>>
```

You can verify that the most significant bit in the `fi` object `a` is 1 by looking at the binary representation of `a`.

```
disp(bin(a))

100110
```

Extended Capabilities

C/C++ Code Generation

Generate C and C++ code using MATLAB® Coder™.

HDL Code Generation

Generate Verilog and VHDL code for FPGA and ASIC designs using HDL Coder™.

See Also

`bitand` | `bitandreduce` | `bitconcat` | `bitget` | `bitor` | `bitorreduce` | `bitset` | `bitxor` | `bitxorreduce` | `getlsb`

Introduced in R2007b

globalfimath

Configure global fimath and return handle object

Syntax

```
G = globalfimath
G = globalfimath('PropertyName1',PropertyValue1,...)
G = globalfimath(f)
```

Description

`G = globalfimath` returns a handle object to the global fimath. The global fimath has identical properties to a `fimath` object but applies globally.

`G = globalfimath('PropertyName1',PropertyValue1,...)` sets the global fimath using the named properties and their corresponding values. Properties that you do not specify in this syntax are automatically set to that of the current global fimath.

`G = globalfimath(f)` sets the properties of the global fimath to match those of the input `fimath` object `f`, and returns a handle object to it.

Unless, in a previous release, you used the `saveglobalfimathpref` function to save global fimath settings to your MATLAB preferences, the global fimath properties you set with the `globalfimath` function apply only to your current MATLAB session. It is best practice to remove global fimath from the MATLAB preferences so that you start each MATLAB session using the default `fimath` settings. To remove the global fimath, use the `removeglobalfimathpref` function.

Examples

Modifying globalfimath

Use the `globalfimath` function to set, change, and reset the global fimath.

Create a `fimath` object and use it as the global fimath.

```
G = globalfimath('RoundMode','Floor','OverflowMode','Wrap')
```

```
G =
    RoundingMethod: Floor
    OverflowAction: Wrap
    ProductMode: FullPrecision
    SumMode: FullPrecision
```

Create another `fimath` object using the new default.

```
F1 = fimath
```

```
F1 =
    RoundingMethod: Floor
    OverflowAction: Wrap
```



```
ProductMode: FullPrecision
SumMode: FullPrecision
```

Create a fi object, A, associated with the global fimath.

```
A = fi(pi)
```

```
A =
    3.1416
```

```
DataTypeMode: Fixed-point: binary point scaling
Signedness: Signed
WordLength: 16
FractionLength: 13
```

Now set the "SumMode" property of the global fimath to "KeepMSB" and retain all the other property values of the current global fimath.

```
G = globalfimath('SumMode','KeepMSB')
```

```
G =
    RoundingMethod: Floor
    OverflowAction: Wrap
    ProductMode: FullPrecision
    SumMode: KeepMSB
    SumWordLength: 32
    CastBeforeSum: true
```

Change the global fimath by directly interacting with the handle object G.

```
G.ProductMode = 'SpecifyPrecision'
```

```
G =
    RoundingMethod: Floor
    OverflowAction: Wrap
    ProductMode: SpecifyPrecision
    ProductWordLength: 32
    ProductFractionLength: 30
    SumMode: KeepMSB
    SumWordLength: 32
    CastBeforeSum: true
```

Reset the global fimath to the factory default by calling the reset method on G. This is equivalent to using the resetglobalfimath function.

```
reset(G);
```

```
G
G =
    RoundingMethod: Nearest
    OverflowAction: Saturate
    ProductMode: FullPrecision
    SumMode: FullPrecision
```

Tips

If you always use the same `fimath` settings and you are not sharing code with other people, using the `globalfimath` function is a quick, convenient method to configure these settings. However, if

you share the code with other people or if you use the `fiaccel` function to accelerate the algorithm or you generate C code for your algorithm, consider the following alternatives.

Goal	Issue Using <code>globalfimath</code>	Solution
Share code	If you share code with someone who is using different global <code>fimath</code> settings, they might see different results.	Separate the <code>fimath</code> properties from your algorithm by using types tables. For more information, see “Separate Data Type Definitions from Algorithm”.
Accelerate your algorithm using <code>fiaccel</code> or generate C code from your MATLAB algorithm using <code>codegen</code>	You cannot use <code>globalfimath</code> within that algorithm. If you generate code with one <code>globalfimath</code> setting and run it with a different <code>globalfimath</code> setting, results might vary. For more information, see <code>Specifying Default fimath Values for MEX Functions</code> .	Use types tables in the algorithm from which you want to generate code. This insulates you from the global settings and makes the code portable. For more information, see “Separate Data Type Definitions from Algorithm”.

See Also

`codegen` | `fiaccel` | `fimath` | `removeglobalfimathpref` | `resetglobalfimath`

Introduced in R2010a

gt

Determine whether real-world value of one `fi` object is greater than another

Syntax

```
c = gt(a,b)
a > b
```

Description

`c = gt(a,b)` is called for the syntax `a > b` when `a` or `b` is a `fi` object. `a` and `b` must have the same dimensions unless one is a scalar. A scalar can be compared with another object of any size.

`a > b` does an element-by-element comparison between `a` and `b` and returns a matrix of the same size with elements set to 1 where the relation is true, and 0 where the relation is false.

In relational operations comparing a floating-point value to a fixed-point value, the floating-point value is cast to the same word length and signedness as the `fi` object, with best-precision scaling.

Examples

Compare Two `fi` Objects

Use the `gt` function to determine whether the real-world value of one `fi` object is greater than another.

```
a = fi(pi);
b = fi(pi, 1, 32);
a > b
```

```
ans = logical
      1
```

Input `a` has a 16-bit word length, while input `b` has a 32-bit word length. The `gt` function returns 1 because after quantization, the value of `a` is greater than that of `b`.

Compare a Double to a `fi` Object

When comparing a double to a `fi` object, the double is cast to the same word length and signedness of the `fi` object.

```
a = fi(pi);
b = pi;
a > b
```

```
ans = logical  
     0
```

The `gt` function casts `b` to the same word length as `a`, and returns `0` because the two inputs have the same real-world value. This behavior allows relational operations to work between `fi` objects and floating-point constants without introducing floating-point values in generated code.

Extended Capabilities

C/C++ Code Generation

Generate C and C++ code using MATLAB® Coder™.

Usage notes and limitations:

- Fixed-point signals with different biases are not supported.

HDL Code Generation

Generate Verilog and VHDL code for FPGA and ASIC designs using HDL Coder™.

See Also

`eq` | `ge` | `le` | `lt` | `ne`

Introduced before R2006a

half

Construct half-precision numeric object

Description

Use the `half` constructor to assign a half-precision data type to a number or variable. A half-precision data type occupies 16 bits of memory, but its floating-point representation enables it to handle wider dynamic ranges than integer or fixed-point data types of the same size.

For more information, see “Floating-Point Numbers”.

Creation

Syntax

```
a = half(v)
```

Description

`a = half(v)` converts the values in `v` to half-precision.

Input Arguments

v — Input array

scalar | vector | matrix | multidimensional array

Input array, specified as a scalar, vector, matrix, or multidimensional array.

Data Types: `single` | `double` | `int8` | `int16` | `int32` | `int64` | `uint8` | `uint16` | `uint32` | `uint64` | `logical`

Object Functions

These functions are supported for use with half-precision inputs.

Math and Arithmetic

<code>abs</code>	Absolute value and complex magnitude
<code>acos</code>	Inverse cosine in radians
<code>acosh</code>	Inverse hyperbolic cosine
<code>asin</code>	Inverse sine in radians
<code>asinh</code>	Inverse hyperbolic sine
<code>atan</code>	Inverse tangent in radians
<code>atan2</code>	Four-quadrant inverse tangent
<code>atanh</code>	Inverse hyperbolic tangent
<code>ceil</code>	Round toward positive infinity
<code>conj</code>	Complex conjugate

conv	Convolution and polynomial multiplication
conv2	2-D convolution
cos	Cosine of argument in radians
cospi	Compute $\cos(X*\pi)$ accurately
dot	Dot product
exp	Exponential
expm1	Compute $\exp(x)-1$ accurately for small values of x
fft	Fast Fourier transform
fft2	2-D fast Fourier transform
fftn	N-D fast Fourier transform
fftshift	Shift zero-frequency component to center of spectrum
fix	Round toward zero
floor	Round toward negative infinity
fma	Multiply and add using fused multiply add approach
hypot	Square root of sum of squares (hypotenuse)
ifft	Inverse fast Fourier transform
ifft2	2-D inverse fast Fourier transform
ifftn	Multidimensional inverse fast Fourier transform
ifftshift	Inverse zero-frequency shift
imag	Imaginary part of complex number
ldivide	Left array division
log	Natural logarithm
log10	Common logarithm (base 10)
log1p	Compute $\log(1+x)$ accurately for small values of x
mean	Average or mean value of array
minus	Subtraction
mldivide	Solve systems of linear equations $Ax = B$ for x
mod	Remainder after division (modulo operation)
mrdivide	Solve systems of linear equations $xA = B$ for x
mtimes	Matrix multiplication
plus	Add numbers, append strings
pow10	Base 10 power and scale half-precision numbers
pow2	Base 2 power and scale floating-point numbers
power	Element-wise power
prod	Product of array elements
rdivide	Right array division
real	Real part of complex number
rem	Remainder after division
round	Round to nearest decimal or integer
rsqrt	Reciprocal square root
sign	Sign function (signum function)
sin	Sine of argument in radians
sinh	Hyperbolic sine
sinpi	Compute $\sin(X*\pi)$ accurately
sqrt	Square root
sum	Sum of array elements
tan	Tangent of argument in radians
tanh	Hyperbolic tangent
times	Multiplication
uminus	Unary minus
uplus	Unary plus

Data Types

cast	Convert variable to different data type
cell	Cell array
double	Double-precision arrays
eps	Floating-point relative accuracy
Inf	Create array of all Inf values
int16	16-bit signed integer arrays
int32	32-bit signed integer arrays
int64	64-bit signed integer arrays
int8	8-bit signed integer arrays
isa	Determine if input has specified data type
isfloat	Determine whether input is floating-point data type
islogical	Determine if input is logical array
isnan	Determine which array elements are NaN
isnumeric	Determine whether input is numeric array
isreal	Determine whether array uses complex storage
logical	Convert numeric values to logicals
NaN	Create array of all NaN values
single	Single-precision arrays
uint16	16-bit unsigned integer arrays
uint32	32-bit unsigned integer arrays
uint64	64-bit unsigned integer arrays
uint8	8-bit unsigned integer arrays

Relational and Logical Operators

all	Determine if all array elements are nonzero or true
and	Find logical AND
any	Determine if any array elements are nonzero
eq	Determine equality
ge	Determine greater than or equal to
gt	Determine greater than
isequal	Determine array equality
isequaln	Determine array equality, treating NaN values as equal
le	Determine less than or equal to
lt	Determine less than
ne	Determine inequality
not	Find logical NOT
or	Find logical OR

Array and Matrix Operations

cat	Concatenate arrays
circshift	Shift array circularly
colon	Vector creation, array subscripting, and for-loop iteration
complex	Create complex array
ctranspose	Complex conjugate transpose
eye	Identity matrix
flip	Flip order of elements
full	Convert sparse matrix to full storage
horzcat	Horizontal concatenation for heterogeneous arrays
iscolumn	Determine whether input is column vector

isempty	Determine whether array is empty
isfinite	Determine which array elements are finite
isinf	Determine which array elements are infinite
ismatrix	Determine whether input is matrix
isrow	Determine whether input is row vector
isscalar	Determine whether input is scalar
isvector	Determine whether input is vector
length	Length of largest array dimension
max	Maximum elements of an array
min	Minimum elements of an array
ndims	Number of array dimensions
numel	Number of array elements
ones	Create array of all ones
permute	Permute array dimensions
repelem	Repeat copies of array elements
repmat	Repeat copies of array
reshape	Reshape array
size	Array size
subsasgn	Redefine subscripted assignment
subsref	Subscripted reference
transpose	Transpose vector or matrix
vertcat	Vertical concatenation for heterogeneous arrays
zeros	Create array of all zeros

Language Fundamentals

display Show information about variable or result of expression

Graphics

area	Area of 2-D alpha shape
bar	Bar graph
barh	Horizontal bar graph
fplot	Plot expression or function
line	Create primitive line
plot	2-D line plot
plot3	3-D point or line plot
plotmatrix	Scatter plot matrix
rgbplot	Plot colormap
scatter	Scatter plot
scatter3	3-D scatter plot
xlim	Set or query x-axis limits
ylim	Set or query y-axis limits
zlim	Set or query z-axis limits

Deep Learning

activations	Compute deep learning network layer activations
classify	Classify data using a trained deep learning neural network
predict	Reconstruct the inputs using trained autoencoder
predictAndUpdateState	Predict responses using a trained recurrent neural network and update the network state

To display the complete list of supported functions, at the MATLAB Command Window, enter:

```
methods(half(1))
```

Examples

Convert Value to Half Precision

To cast a double-precision number to half precision, use the `half` function.

```
a = half(pi)
```

```
a =
```

```
half
```

```
3.1406
```

You can also use the `half` function to cast an existing variable to half-precision.

```
v = single(magic(3))
```

```
v = 3x3 single matrix
```

```
8     1     6
3     5     7
4     9     2
```

```
a = half(v)
```

```
a =
```

```
3x3 half matrix
```

```
8     1     6
3     5     7
4     9     2
```

Limitations

The following functions which support half-precision inputs, do not support complex half-precision inputs.

- `rsqrt`
- `fma`

Extended Capabilities

C/C++ Code Generation

Generate C and C++ code using MATLAB® Coder™.

All functions that support half-precision inputs support code generation, except for the `rsqrt` function.

In MATLAB, the `isobject` function returns true with a half-precision input. In generated code, this function returns false.

If your target hardware does not have native support for half-precision, then `half` is used as a storage type, with arithmetic operations performed in single-precision.

Some functions use `half` only as a storage type and the arithmetic is performed in single-precision, regardless of the target hardware.

For deep learning code generation, half inputs are cast to single precision and computations are performed in single precision.

GPU Code Generation

Generate CUDA® code for NVIDIA® GPUs using GPU Coder™.

- CUDA® compute capability of 5.3 or higher is required for generating and executing code with half-precision data types.
- CUDA toolkit version of 10.0 or later is required for generating and executing code with half-precision data types.
- You must set the memory allocation (`malloc`) mode to 'Discrete' for generating CUDA code.
- Half-precision complex data types are not supported for GPU code generation.
- For GPU Code generation, you can perform half-precision matrix multiplication with real inputs.
- In MATLAB, the `isobject` function returns true with a half-precision input. In generated code, this function returns false.
- `fft`, `fft2`, `fftn`, `fftshift`, `ifft`, `ifft2`, `ifftn`, and `ifftshift` are not supported for GPU code generation.
- If your target hardware does not have native support for half-precision, then `half` is used as a storage type, with arithmetic operations performed in single-precision.
- Some functions use `half` only as a storage type and the arithmetic is performed in single-precision, regardless of the target hardware.
- For deep learning code generation, half inputs are cast to single precision and computations are performed in single precision. To perform computations in half, set the library target to 'tensorrt' and set the data type to 'FP16' in `coder.DeepLearningConfig`.

See Also

`double` | `single`

Topics

"Floating-Point Numbers"

"Generate Code for Sobel Edge Detection That Uses Half-Precision Data Type" (MATLAB Coder)
Edge Detection with Sobel Method in Half-Precision (GPU Coder)

Introduced in R2018b

hex

Hexadecimal representation of stored integer of `fi` object

Syntax

`b = hex(a)`

Description

`b = hex(a)` returns the stored integer of `fi` object `a` in hexadecimal format as a character vector.

Fixed-point numbers can be represented as

$$\text{real-worldvalue} = 2^{-\text{fractionlength}} \times \text{storedinteger}$$

or, equivalently as

$$\text{real-worldvalue} = (\text{slope} \times \text{storedinteger}) + \text{bias}$$

The stored integer is the raw binary number, in which the binary point is assumed to be at the far right of the word.

Examples

View Stored Integer of `fi` Object in Hexadecimal Format

Create a signed `fi` object with values -1 and 1, a word length of 8 bits, and a fraction length of 7 bits.

```
a = fi([-1 1], 1, 8, 7)
```

```
a=1x2 object
-1.0000    0.9922
```

```
      DataTypeMode: Fixed-point: binary point scaling
      Signedness: Signed
      WordLength: 8
      FractionLength: 7
```

Find the hexadecimal representation of the stored integers of `fi` object `a`.

```
b = hex(a)
```

```
b =
'80    7f'
```

Write Hex Data to a File

This example shows how to write hexadecimal data from the MATLAB workspace into a text file.

Define your data and create a writable text file called `hexdata.txt`.

```
x = (0:15)'/16;  
a = fi(x, 0, 16, 16);  
h = fopen('hexdata.txt', 'w');
```

Use the `fprintf` function to write your data to the `hexdata.txt` file.

```
for k = 1:length(a)  
    fprintf(h, '%s\n', hex(a(k)));  
end  
  
fclose(h);
```

To see the contents of the file you created, use the `type` function.

```
type hexdata.txt
```

```
0000  
1000  
2000  
3000  
4000  
5000  
6000  
7000  
8000  
9000  
a000  
b000  
c000  
d000  
e000  
f000
```

Read Hex Data From a File

This example shows how to read hexadecimal data from a text file back into the MATLAB workspace.

Define your data, create a writable text file called `hexdata.txt`, and write your data to the `hexdata.txt` file.

```
x = (0:15)'/16;  
a = fi(x, 0, 16, 16);  
h = fopen('hexdata.txt', 'w');  
  
for k = 1:length(a)  
    fprintf(h, '%s\n', hex(a(k)));  
end  
  
fclose(h);
```

Open `hexdata.txt` for reading and read its contents into a workspace variable

```
h = fopen('hexdata.txt', 'r');

nextline = '';
str = '';

while ischar(nextline)
    nextline = fgetl(h);
    if ischar(nextline)
        str = [str; nextline];
    end
end

fclose(h);
```

Create a `fi` object with the correct scaling and assign it the hex values stored in the `str` variable.

```
b = fi([], 0, 16, 16);
b.hex = str
```

`b=16x1 object`

```
0
0.0625
0.1250
0.1875
0.2500
0.3125
0.3750
0.4375
0.5000
0.5625
0.6250
0.6875
0.7500
0.8125
0.8750
0.9375
```

```
DataTypeMode: Fixed-point: binary point scaling
Signedness: Unsigned
WordLength: 16
FractionLength: 16
```

Input Arguments

a — **fi** object to view in hexadecimal

`fi` object

Input `fi` object to view in hexadecimal.

Data Types: `fi`

See Also

`bin` | `dec` | `oct` | `storedInteger`

Introduced before R2006a

hex2num

Convert hexadecimal string to number using quantizer object

Syntax

```
x = hex2num(q,h)
[x1,x2,...] = hex2num(q,h1,h2,...)
```

Description

`x = hex2num(q,h)` converts hexadecimal character vector `h` to numeric matrix `x`. The attributes of the numbers in `x` are specified by quantizer object `q`. When `h` is a cell array, `hex2num` returns `x` as a cell array of the same dimension containing numbers. For fixed-point hexadecimal representations, `hex2num` uses two's complement representation. For floating-point, the representation is IEEE Standard 754 style.

When there are fewer hexadecimal digits than needed to represent the number, the fixed-point conversion zero-fills on the left. Floating-point conversion zero-fills on the right.

`[x1,x2,...] = hex2num(q,h1,h2,...)` converts hexadecimal representations `h1, h2,...` to numeric matrices `x1, x2,....`

`hex2num` and `num2hex` are inverses of one another, with the distinction that `num2hex` returns the hexadecimal representations in a column.

Examples

To create all the 4-bit fixed-point two's complement numbers in fractional form, use the following code.

```
q = quantizer([4 3]);
h = ['7 3 F B'; '6 2 E A'; '5 1 D 9'; '4 0 C 8'];
x = hex2num(q,h)
```

`x =`

```
    0.8750    0.3750   -0.1250   -0.6250
    0.7500    0.2500   -0.2500   -0.7500
    0.6250    0.1250   -0.3750   -0.8750
    0.5000         0   -0.5000   -1.0000
```

See Also

[bin2num](#) | [num2bin](#) | [num2hex](#) | [num2int](#)

Introduced before R2006a

horzcat

Concatenate multiple `fi` objects horizontally

Syntax

```
C = horzcat(A,B)
C = horzcat(A1,A2,...An)
```

Description

`C = horzcat(A,B)` concatenates `B` horizontally to the end of `A` when `A` and `B` have compatible sizes (the lengths of the dimensions match except in the second dimension).

`C = horzcat(A1,A2,...An)` concatenates `A1,A2,...,An` horizontally.

`horzcat` is equivalent to using square brackets for horizontally concatenating arrays. For example, `[A,B]` or `[A B]` is equal to `horzcat(A,B)` when `A` and `B` are compatible arrays.

Note The `fimath` and `numericType` properties of a concatenated matrix of `fi` objects, `C`, are taken from the leftmost `fi` object in the list `A1,A2,...,An`.

Input Arguments

A — First input

scalar | vector | matrix | multidimensional array

First input, specified as a scalar, vector, matrix, or multidimensional array.

B — Second input

scalar | vector | matrix | multidimensional array

Second input, specified as a scalar, vector, matrix, or multidimensional array.

The elements of `B` are concatenated to the end of the first input along the second dimension. The sizes of the input arguments must be compatible. For example, if the first input is a matrix of size 3-by-2, then `B` must have 3 rows.

A1,A2,...An — List of inputs

scalar | vector | matrix | multidimensional array

List of inputs, specified as a comma-separated list of elements to concatenate in the order they are specified.

Any number of matrices can be concatenated within one pair of brackets. Multidimensional arrays are horizontally concatenated along the second dimension.

The inputs must have compatible sizes. For example, if `A1` is a column vector of length `m`, then the remaining inputs must each have `m` rows to concatenate horizontally.

Tips

- Horizontal and vertical concatenation can be combined together, as in `[1 2;3 4]`.
- The matrices in a concatenation expression can themselves be formed via a concatenation, as in `[a b;[c d]]`.
- `[A B;C]` is allowed if the number of rows of A equals the number of rows of B and if the number of columns of A plus the number of columns of B equals the number of columns of C.
- When concatenating an empty array to a nonempty array, `horzcat` omits the empty array in the output. For example,

```
horzcat(fi([1 2]),[])
```

```
ans =
```

```
1     2
```

```
      DataTypeMode: Fixed-point: binary point scaling  
      Signedness: Signed  
      WordLength: 16  
      FractionLength: 13
```

Extended Capabilities

C/C++ Code Generation

Generate C and C++ code using MATLAB® Coder™.

HDL Code Generation

Generate Verilog and VHDL code for FPGA and ASIC designs using HDL Coder™.

See Also

`vertcat`

Introduced before R2006a

innerprodintbits

Number of integer bits needed for fixed-point inner product

Syntax

```
innerprodintbits(a,b)
```

Description

`innerprodintbits(a,b)` computes the minimum number of integer bits necessary in the inner product of $a' * b$ to guarantee that no overflows occur and to preserve best precision.

- a and b are `fi` vectors.
- The values of a are known.
- Only the numeric type of b is relevant. The values of b are ignored.

Examples

The primary use of this function is to determine the number of integer bits necessary in the output Y of an FIR filter that computes the inner product between constant coefficient row vector B and state column vector Z . For example,

```
for k=1:length(X);  
    Z = [X(k);Z(1:end-1)];  
    Y(k) = B * Z;  
end
```

Algorithms

In general, an inner product grows $\log_2(n)$ bits for vectors of length n . However, in the case of this function the vector a is known and its values do not change. This knowledge is used to compute the smallest number of integer bits that are necessary in the output to guarantee that no overflow will occur.

The largest gain occurs when the vector b has the same sign as the constant vector a . Therefore, the largest gain due to the vector a is $a * \text{sign}(a')$, which is equal to $\text{sum}(\text{abs}(a))$.

The overall number of integer bits necessary to guarantee that no overflow occurs in the inner product is computed by:

```
n = ceil(log2(sum(abs(a)))) + number of integer bits in b + 1 sign bit
```

The extra sign bit is only added if both a and b are signed and b attains its minimum. This prevents overflow in the event of $(-1)*(-1)$.

Introduced before R2006a

int

Get stored integer value of a `fi` object

Syntax

```
i = int(a)
```

Description

`i = int(a)` returns the integer value of a `fi` object, stored in one of the built-in integer data types.

Examples

Get the Stored Integer Value of a `fi` Object

Create a `fi` object with default settings. Use the `int` function to get its stored integer value. The output is an `int16` because the input used the default word length of 16-bits.

```
a = fi(pi);
b = int(a)

b = int16
    25736
```

Create a `fi` object that uses a 20-bit word length and get the stored integer value of the `fi` object.

```
a = fi(pi,1,20);
b = int(a)

b = int32
    411775
```

The output is an `int32` to accommodate the larger input word length.

Input Arguments

a — Fixed-point numeric object

scalar | vector | matrix | multidimensional array

Fixed-point numeric object from which you want to get the stored integer value. The word length of the input determines the data type of the output.

Data Types: `fi`

Complex Number Support: Yes

Output Arguments

i — Stored integer value

scalar | vector | matrix | multidimensional array

Stored integer value of the input `fi` object, returned as one of the built-in integer data types. The word length of the input determines the data type of the output. The output has the same dimensions as the input.

See Also

Functions

`bin` | `hex` | `oct` | `sdec` | `storedInteger`

Introduced in R2006a

int8

Convert `fi` object to signed 8-bit integer

Syntax

```
c = int8(a)
```

Description

`c = int8(a)` returns the built-in `int8` value of `fi` object `a`, based on its real world value. If necessary, the data is rounded-to-nearest and saturated to fit into an `int8`.

Examples

This example shows the `int8` values of a `fi` object.

```
a = fi([-pi 0.1 pi],1,8);  
c = int8(a)
```

```
c =
```

```
    -3     0     3
```

Extended Capabilities

C/C++ Code Generation

Generate C and C++ code using MATLAB® Coder™.

HDL Code Generation

Generate Verilog and VHDL code for FPGA and ASIC designs using HDL Coder™.

See Also

[int16](#) | [int32](#) | [int64](#) | [storedInteger](#) | [uint16](#) | [uint32](#) | [uint64](#) | [uint8](#)

Introduced before R2006a

int16

Convert `fi` object to signed 16-bit integer

Syntax

```
c = int16(a)
```

Description

`c = int16(a)` returns the built-in `int16` value of `fi` object `a`, based on its real world value. If necessary, the data is rounded-to-nearest and saturated to fit into an `int16`.

Examples

This example shows the `int16` values of a `fi` object.

```
a = fi([-pi 0.1 pi],1,16);  
c = int16(a)
```

```
c =
```

```
    -3     0     3
```

Extended Capabilities

C/C++ Code Generation

Generate C and C++ code using MATLAB® Coder™.

HDL Code Generation

Generate Verilog and VHDL code for FPGA and ASIC designs using HDL Coder™.

See Also

[int32](#) | [int64](#) | [int8](#) | [storedInteger](#) | [uint16](#) | [uint32](#) | [uint64](#) | [uint8](#)

Introduced before R2006a

int32

Convert `fi` object to signed 32-bit integer

Syntax

```
c = int32(a)
```

Description

`c = int32(a)` returns the built-in `int32` value of `fi` object `a`, based on its real world value. If necessary, the data is rounded-to-nearest and saturated to fit into an `int32`.

Examples

This example shows the `int32` values of a `fi` object.

```
a = fi([-pi 0.1 pi],1,32);  
c = int32(a)
```

```
c =
```

```
    -3     0     3
```

Extended Capabilities

C/C++ Code Generation

Generate C and C++ code using MATLAB® Coder™.

HDL Code Generation

Generate Verilog and VHDL code for FPGA and ASIC designs using HDL Coder™.

See Also

[int16](#) | [int64](#) | [int8](#) | [storedInteger](#) | [uint16](#) | [uint32](#) | [uint64](#) | [uint8](#)

Introduced before R2006a

int64

Convert `fi` object to signed 64-bit integer

Syntax

```
c = int64(a)
```

Description

`c = int64(a)` returns the built-in `int64` value of `fi` object `a`, based on its real world value. If necessary, the data is rounded-to-nearest and saturated to fit into an `int64`.

Examples

This example shows the `int64` values of a `fi` object.

```
a = fi([-pi 0.1 pi],1,64);  
c = int64(a)
```

```
c =
```

```
    -3     0     3
```

Extended Capabilities

C/C++ Code Generation

Generate C and C++ code using MATLAB® Coder™.

See Also

[int16](#) | [int32](#) | [int8](#) | [storedInteger](#) | [uint16](#) | [uint32](#) | [uint64](#) | [uint8](#)

Introduced in R2008b

intmax

Largest positive stored integer value representable by `numericType` of `fi` object

Syntax

```
x = intmax(a)
```

Description

`x = intmax(a)` returns the largest positive stored integer value representable by the `numericType` of `a`.

Examples

```
a = fi(pi, true, 16, 12);  
x = intmax(a)
```

```
x =
```

```
    32767
```

```
    DataTypeMode: Fixed-point: binary point scaling  
    Signedness: Signed  
    WordLength: 16  
    FractionLength: 0
```

See Also

[eps](#) | [intmin](#) | [lowerbound](#) | [lsb](#) | [range](#) | [realmax](#) | [realmin](#) | [stripScaling](#) | [upperbound](#)

Introduced before R2006a

intmin

Smallest stored integer value representable by `numericType` of `fi` object

Syntax

```
x = intmin(a)
```

Description

`x = intmin(a)` returns the smallest stored integer value representable by the `numericType` of `a`.

Examples

```
a = fi(pi, true, 16, 12);  
x = intmin(a)
```

```
x =
```

```
-32768
```

```
    DataTypeMode: Fixed-point: binary point scaling  
    Signedness: Signed  
    WordLength: 16  
    FractionLength: 0
```

See Also

`eps` | `intmax` | `lowerbound` | `lsb` | `range` | `realmax` | `realmin` | `stripScaling` | `upperbound`

Introduced before R2006a

isboolean

Determine whether input is Boolean

Syntax

```
tf = isboolean(a)
tf = isboolean(T)
```

Description

`tf = isboolean(a)` returns 1 (true) when the `DataType` property of `fi` object `a` is Boolean. Otherwise, it returns 0 (false).

`tf = isboolean(T)` returns 1 (true) when the `DataType` property of `numericType` object `T` is Boolean. Otherwise, it returns 0 (false).

Examples

Determine Whether `fi` Object is a Boolean

Create a `fi` object and determine if its data type is Boolean.

```
a = fi(pi)
a =
    3.1416

        DataTypeMode: Fixed-point: binary point scaling
        Signedness: Signed
        WordLength: 16
        FractionLength: 13

tf = isboolean(a)
tf = logical
    0

a = fi(pi, 'DataType', 'Boolean')
a =
    1

        DataTypeMode: Boolean

tf = isboolean(a)
tf = logical
    1
```

Determine Whether numericType Object is a Boolean

Create a numericType object and determine if its data type is Boolean.

```
T = numericType
```

```
T =
```

```
      DataTypeMode: Fixed-point: binary point scaling
      Signedness: Signed
      WordLength: 16
      FractionLength: 15
```

```
tf = isboolean(T)
```

```
tf = logical
    0
```

```
T = numericType('Boolean')
```

```
T =
```

```
      DataTypeMode: Boolean
```

```
tf = isboolean(T)
```

```
tf = logical
    1
```

Input Arguments

a — Input **fi** object

scalar | vector | matrix | multidimensional array

Input **fi** object, specified as a scalar, vector, matrix, or multidimensional array.

Data Types: **fi**

T — Input **numericType** object

scalar

Input **numericType** object, specified as a scalar.

See Also

`isdouble` | `isfixed` | `isfloat` | `isscaledouble` | `isscalingbinarypoint` | `isscalingstopebias` | `isscalingunspecified` | `issingle`

Introduced in R2008a

isdouble

Determine whether input is double-precision data type

Syntax

```
tf = isdouble(a)
tf = isdouble(T)
```

Description

`tf = isdouble(a)` returns 1 (true) when the `DataType` property of `fi` object `a` is double. Otherwise, it returns 0 (false).

`tf = isdouble(T)` returns 1 (true) when the `DataType` property of `numericType` object `T` is double. Otherwise, it returns 0 (false).

Examples

Determine Whether `fi` Object is a double

Create a `fi` object and determine if its data type is double.

```
a = fi(pi)
a =
    3.1416

        DataTypeMode: Fixed-point: binary point scaling
        Signedness: Signed
        WordLength: 16
        FractionLength: 13

tf = isdouble(a)
tf = logical
    0

a = fi(pi, 'DataType', 'double')
a =
    3.1416

        DataTypeMode: Double

tf = isdouble(a)
tf = logical
    1
```

Determine Whether numericType Object is a double

Create a numericType object and determine if its data type is double.

```
T = numericType
```

```
T =
```

```
      DataTypeMode: Fixed-point: binary point scaling  
      Signedness: Signed  
      WordLength: 16  
      FractionLength: 15
```

```
tf = isdouble(T)
```

```
tf = logical  
    0
```

```
T = numericType('Double')
```

```
T =
```

```
      DataTypeMode: Double
```

```
tf = isdouble(T)
```

```
tf = logical  
    1
```

Input Arguments

a — Input **fi** object

scalar | vector | matrix | multidimensional array

Input **fi** object, specified as a scalar, vector, matrix, or multidimensional array.

Data Types: **fi**

T — Input **numericType** object

scalar

Input **numericType** object, specified as a scalar.

See Also

[isboolean](#) | [isfixed](#) | [isfloat](#) | [isscaleddouble](#) | [isscaledtype](#) | [isscalingbinarypoint](#) | [isscalingstopebias](#) | [isscalingunspecified](#) | [issingle](#)

Introduced in R2008a

isequal

Determine whether real-world values of two `fi` objects are equal, or determine whether properties of two `fimath`, `numerictype`, or `quantizer` objects are equal

Syntax

```
y = isequal(a,b,...)
y = isequal(F,G,...)
y = isequal(T,U,...)
y = isequal(q,r,...)
```

Description

`y = isequal(a,b,...)` returns logical 1 (true) if all the `fi` object inputs have the same real-world value. Otherwise, it returns logical 0 (false).

In relational operations comparing a floating-point value to a fixed-point value, the floating-point value is cast to the same word length and signedness as the `fi` object, with best-precision scaling.

`y = isequal(F,G,...)` returns logical 1 (true) if all the `fimath` object inputs have the same properties. Otherwise, it returns logical 0 (false).

`y = isequal(T,U,...)` returns logical 1 (true) if all the `numerictype` object inputs have the same properties. Otherwise, it returns logical 0 (false).

`y = isequal(q,r,...)` returns logical 1 (true) if all the `quantizer` object inputs have the same properties. Otherwise, it returns logical 0 (false).

Examples

Compare Two `fi` Objects

Use the `isequal` function to determine if two `fi` objects have the same real-world value.

```
format long
a = fi(pi)

a =
    3.141601562500000

        DataTypeMode: Fixed-point: binary point scaling
        Signedness: Signed
        WordLength: 16
        FractionLength: 13

b = fi(pi,1,32)

b =
    3.141592653468251
```

```
        DataTypeMode: Fixed-point: binary point scaling
        Signedness: Signed
        WordLength: 32
        FractionLength: 29
```

```
y = isequal(a,b)
```

```
y = logical
    0
```

Input `a` has a 16-bit word length, while input `b` has a 32-bit word length. The `isequal` function returns `0` because the two `fi` objects do not have the same real-world value.

Compare a Double to a `fi` Object

When comparing a double to a `fi` object, the double is cast to the same word length and signedness of the `fi` object.

```
a = fi(pi);
b = pi;
y = isequal(a,b)
```

```
y = logical
    1
```

The `isequal` function casts `b` to the same word length as `a`, and returns `1`. This behavior allows relational operations to work between `fi` objects and floating-point constants without introducing floating-point values in generated code.

Compare Two `fimath` Objects

Use the `isequal` function to determine if two `fimath` objects have the same properties.

```
F = fimath('OverflowAction', 'Saturate', 'RoundingMethod', 'Convergent');
G = fimath('RoundingMethod', 'Convergent', 'ProductMode', 'FullPrecision');
y = isequal(F,G)
```

```
y = logical
    1
```

Compare Two `numericType` Objects

Use the `isequal` function to determine if two `numericType` objects have the same properties.

```
T = numericType;
U = numericType(true, 16, 15);
y = isequal(T,U)
```



```
y = logical
    1
```

Compare Two quantizer Objects

Use the `isequal` function to determine if two quantizer objects have the same properties.

```
q = quantizer('fixed', [5 4]);
r = quantizer('fixed', 'floor', 'saturate', [5 4]);
y = isequal(q,r)
```

```
y = logical
    1
```

Input Arguments

a, b, ... — fi objects to be compared

scalar | vector | matrix | multidimensional array

fi objects to be compared, specified as a scalar, vector, matrix, or multidimensional array.

Data Types: fi

Complex Number Support: Yes

F, G, ... — fimath objects to be compared

fimath object

fimath objects to be compared.

T, U, ... — numerictype objects to be compared

scalar | vector | matrix | multidimensional array

numerictype objects to be compared, specified as a scalar, vector, matrix, or multidimensional array.

q, r, ... — quantizer objects to be compared

quantizer object

quantizer objects to be compared.

Extended Capabilities

C/C++ Code Generation

Generate C and C++ code using MATLAB® Coder™.

HDL Code Generation

Generate Verilog and VHDL code for FPGA and ASIC designs using HDL Coder™.

See Also

`eq` | `fi` | `fimath` | `ispropequal` | `numerictype` | `quantizer`

Introduced before R2006a

isequivalent

Determine if two `numerictype` objects have equivalent properties

Syntax

```
y = isequivalent (T1, T2)
```

Description

`y = isequivalent (T1, T2)` determines whether the `numerictype` object inputs have equivalent properties and returns a logical 1 (true) or 0 (false). Two `numerictype` objects are equivalent if they describe the same data type.

Examples

Compare two `numerictype` objects

Use `isequivalent` to determine if two `numerictype` objects have the same data type.

```
T1 = numerictype(1, 16, 2^-12, 0)
```

```
T1 =
```

```

    DataTypeMode: Fixed-point: slope and bias scaling
      Signedness: Signed
    WordLength: 16
      Slope: 2^-12
      Bias: 0

```

```
T2 = numerictype(1, 16, 12)
```

```
T2 =
```

```

    DataTypeMode: Fixed-point: binary point scaling
      Signedness: Signed
    WordLength: 16
    FractionLength: 12

```

```
isequivalent(T1,T2)
```

```
ans = logical
      1
```

Although the Data Type Mode is different for T1 and T2, the function returns 1 (true) because the two objects have the same data type.

Input Arguments

T1, T2 — Inputs to be compared

`numeric` objects

Inputs to be compared, specified as `numeric` objects.

See Also

`eq` | `isequal` | `ispropequal`

Introduced in R2014a

isfi

Determine whether variable is `fi` object

Syntax

```
tf = isfi(a)
```

Description

`tf = isfi(a)` returns 1 (true) if `a` is a `fi` object. Otherwise, it returns 0 (false).

Examples

Determine Whether Variable is a `fi` Object

Create a variable and determine whether it is a `fi` object.

```
a = fi(pi);  
tf = isfi(a)
```

```
tf = logical  
    1
```

```
b = single([1 2 3 4]);  
tf = isfi(b)
```

```
tf = logical  
    0
```

Input Arguments

a — Input array

array

Input array.

Extended Capabilities

C/C++ Code Generation

Generate C and C++ code using MATLAB® Coder™.

Usage notes and limitations:

- Avoid using the `isfi` function in code that you intend to convert using the automated workflow. The value returned by `isfi` in the fixed-point code might differ from the value returned in the original MATLAB algorithm. The behavior of the fixed-point code might differ from the behavior of the original algorithm.

HDL Code Generation

Generate Verilog and VHDL code for FPGA and ASIC designs using HDL Coder™.

See Also

`fi` | `isfimath` | `isfipref` | `isnumericitype` | `isquantizer`

Introduced before R2006a

isfimath

Determine whether variable is fimath object

Syntax

```
tf = isfimath(F)
```

Description

`tf = isfimath(F)` returns 1 (true) if `F` is a fimath object. Otherwise, it returns 0 (false).

Examples

Determine Whether Variable is a fimath Object

Create a variable and determine whether it is a fimath object

```
F = fimath;  
tf = isfimath(F)
```

```
tf = logical  
    1
```

```
T = numerictype;  
tf = isfimath(T)
```

```
tf = logical  
    0
```

```
A = fi([1 2 3 4]);  
tf = isfimath(A)
```

```
tf = logical  
    0
```

Input Arguments

F — Input array

array

Input array.

Extended Capabilities

C/C++ Code Generation

Generate C and C++ code using MATLAB® Coder™.

HDL Code Generation

Generate Verilog and VHDL code for FPGA and ASIC designs using HDL Coder™.

See Also

`fimath` | `isfi` | `isfipref` | `isnumericitype` | `isquantizer`

Introduced before R2006a

isfimathlocal

Determine whether `fi` object has local `fimath`

Syntax

```
tf = isfimathlocal(a)
```

Description

`tf = isfimathlocal(a)` returns 1 (true) if the `fi` object `a` has a local `fimath` object. Otherwise, it returns 0 (false).

Examples

Determine Whether `fi` Object has Local `fimath`

Create a `fi` object and determine whether it has local `fimath`.

```
F = fimath;  
a = fi(pi);  
b = fi(pi,F);
```

```
tf_a = isfimathlocal(a)
```

```
tf_a = logical  
      0
```

```
tf_b = isfimathlocal(b)
```

```
tf_b = logical  
      1
```

Input Arguments

a — Input array

array

Input array.

Data Types: `fi`

Extended Capabilities

C/C++ Code Generation

Generate C and C++ code using MATLAB® Coder™.

HDL Code Generation

Generate Verilog and VHDL code for FPGA and ASIC designs using HDL Coder™.

See Also

`fimath` | `isfi` | `isfimathlocal` | `isfipref` | `isnumericitype` | `isquantizer` | `removefimath` | `sfi` | `ufi`

Introduced in R2009b

isfipref

Determine whether input is fipref object

Syntax

```
tf = isfipref(P)
```

Description

`tf = isfipref(P)` returns 1 (true) if P is a fipref object. Otherwise, it returns 0 (false).

Examples

Determine Whether Input is a fipref Object

Create a variable and determine whether it is a fipref object.

```
P = fipref;  
tf = isfipref(P)
```

```
tf = logical  
    1
```

```
F = fimath;  
tf = isfipref(F)
```

```
tf = logical  
    0
```

Input Arguments

P — Input array

array

Input array.

See Also

fipref | isfi | isfimath | isnumericitype | isquantizer

Introduced in R2008a

isfixed

Determine whether input is fixed-point data type

Syntax

```
tf = isfixed(a)
tf = isfixed(T)
tf = isfixed(q)
```

Description

`tf = isfixed(a)` returns 1 (true) when the `DataType` property of `fi` object `a` is `Fixed`. Otherwise, it returns 0 (false).

`tf = isfixed(T)` returns 1 when the `DataType` property of `numericType` object `T` is `Fixed`. Otherwise, it returns 0 (false).

`tf = isfixed(q)` returns 1 when `q` is a fixed-point quantizer object. Otherwise, it returns 0 (false).

Examples

Determine Whether Input is a Fixed-Point Data Type

Create a `fi` object and determine whether it is a fixed-point data type.

```
a = fi([pi pi/2])

a=1x2 object
    3.1416    1.5708

    DataTypeMode: Fixed-point: binary point scaling
    Signedness: Signed
    WordLength: 16
    FractionLength: 13
```

```
tf = isfixed(a)

tf = logical
    1
```

Create a `numericType` object and determine whether it is a fixed-point data type.

```
T = numericType('Double')

T =

    DataTypeMode: Double
```

```
tf = isfixed(T)
tf = logical
    0
```

Create a quantizer object and determine whether it is a fixed-point data type.

```
q = quantizer('mode','single')
q =

    DataMode = single
    Format = [32 8]

tf = isfixed(q)
tf = logical
    0
```

Input Arguments

a — Input **fi** object

scalar | vector | matrix | multidimensional array

Input **fi** object, specified as a scalar, vector, matrix, or multidimensional array.

Data Types: **fi**

T — Input **numeric**type object

scalar

Input **numeric**type object, specified as a scalar.

q — Input quantizer object

scalar

Input quantizer object, specified as a scalar.

See Also

`isboolean` | `isdouble` | `isfloat` | `isscaleddouble` | `isscaledtype` | `isscalingbinarypoint` | `isscalingslopebias` | `isscalingunspecified` | `issingle`

Introduced in R2008a

isfloat

Determine whether input is floating-point data type

Syntax

```
y = isfloat(a)
y = isfloat(T)
y = isfloat(q)
```

Description

`y = isfloat(a)` returns 1 when the `DataType` property of `fi` object `a` is `single`, or `double`, and 0 otherwise.

`y = isfloat(T)` returns 1 when the `DataType` property of `numerictype` object `T` is `single`, or `double`, and 0 otherwise.

`y = isfloat(q)` returns 1 when `q` is a floating-point quantizer, and 0 otherwise.

See Also

`isboolean` | `isdouble` | `isfixed` | `isscaleddouble` | `isscaledtype` | `isscalingbinarypoint` | `isscalingstopebias` | `isscalingunspecified` | `issingle`

Introduced in R2008a

isnumerictype

Determine whether input is numerictype object

Syntax

```
tf = isnumerictype(T)
```

Description

`tf = isnumerictype(T)` returns 1 (true) if T is a numerictype object. Otherwise, it returns 0 (false).

Examples

Determine Whether Input is a numerictype Object

Create a variable and determine whether it is a numerictype object.

```
T = numerictype;  
tf = isnumerictype(T)
```

```
tf = logical  
    1
```

```
q = quantizer;  
tf = isnumerictype(q)
```

```
tf = logical  
    0
```

Input Arguments

T — Input array

array

Input array.

Extended Capabilities

C/C++ Code Generation

Generate C and C++ code using MATLAB® Coder™.

HDL Code Generation

Generate Verilog and VHDL code for FPGA and ASIC designs using HDL Coder™.

See Also

`isfi` | `isfimath` | `isfipref` | `isquantizer` | `numerictype`

Introduced before R2006a

ispropequal

Determine whether properties of two `fi` objects are equal

Syntax

```
tf = ispropequal(a,b)
```

Description

`tf = ispropequal(a,b)` returns 1 (true) if `a` and `b` are both `fi` objects and have the same properties. Otherwise, it returns 0 (false).

Examples

Determine Whether Properties of Two `fi` Objects are Equal

Create two `fi` objects and determine whether they have the same properties.

```
F = fimath;

a = fi(pi);
b = fi(pi,F);
c = fi(pi/2,F);
d = fi(pi/2,0);

tf = ispropequal(a,b)

tf = logical
    1

tf = ispropequal(b,c)

tf = logical
    0

tf = ispropequal(c,d)

tf = logical
    0
```

Input Arguments

a, b — Inputs to be compared (as separate arguments)

arrays

Inputs to be compared, specified as arrays.

Data Types: `fi`

Tips

To compare the real-world values of two `fi` objects `a` and `b`, use `a == b` or `isequal(a,b)`.

See Also

`fi` | `isequal`

Introduced before R2006a

isquantizer

Determine whether input is quantizer object

Syntax

```
tf = isquantizer(q)
```

Description

`tf = isquantizer(q)` returns 1 (true) when `q` is a quantizer object. Otherwise, it returns 0 (false).

Examples

Determine Whether Variable is a quantizer Object

Create a variable and determine whether it is a quantizer object.

```
q = quantizer('fixed', 'Ceiling', 'Wrap', [16 12])
```

```
q =
```

```
      DataMode = fixed
      RoundMode = ceil
      OverflowMode = wrap
      Format = [16 12]
```

```
tf = isquantizer(q)
```

```
tf = logical
     1
```

```
y = quantize(q,[pi pi/2])
```

```
y = 1×2
```

```
     3.1416     1.5708
```

```
tf = isquantizer(y)
```

```
tf = logical
     0
```

Input Arguments

q — Input array

array

Input array.

See Also

`isfi` | `isfimath` | `isfipref` | `isnumericitype` | `quantizer`

Introduced in R2008a

isscaleddouble

Determine whether input is scaled double data type

Syntax

```
tf = isscaleddouble(a)
tf = isscaleddouble(T)
```

Description

`tf = isscaleddouble(a)` returns 1 (true) when the `DataType` property of `fi` object `a` is `ScaledDouble`. Otherwise, it returns 0 (false).

`tf = isscaleddouble(T)` returns 1 (true) when the `DataType` property of `numericType` object `T` is `ScaledDouble`. Otherwise, it returns 0 (false).

Examples

Determine Whether `fi` Object is a Scaled Double

Create a `fi` object and determine whether its `DataType` property is set to `ScaledDouble`.

```
a = fi(pi)
a =
    3.1416

        DataTypeMode: Fixed-point: binary point scaling
          Signedness: Signed
         WordLength: 16
    FractionLength: 13

tf = isscaleddouble(a)
tf = logical
    0

T = numericType('DataType','ScaledDouble');
a = fi(pi,T)
a =
    3.1416

        DataTypeMode: Scaled double: binary point scaling
          Signedness: Signed
         WordLength: 16
    FractionLength: 15

tf = isscaleddouble(a)
```

```
tf = logical
    1
```

Determine Whether numericType Object is a Scaled Double

Create a numericType object and determine whether its DataType property is set to ScaledDouble.

```
T = numericType
```

```
T =
```

```
    DataTypeMode: Fixed-point: binary point scaling
    Signedness: Signed
    WordLength: 16
    FractionLength: 15
```

```
tf = isscaleddouble(T)
```

```
tf = logical
    0
```

```
T = numericType('DataType','ScaledDouble')
```

```
T =
```

```
    DataTypeMode: Scaled double: binary point scaling
    Signedness: Signed
    WordLength: 16
    FractionLength: 15
```

```
tf = isscaleddouble(T)
```

```
tf = logical
    1
```

Input Arguments

a — Input fi object

scalar | vector | matrix | multidimensional array

Input fi object, specified as a scalar, vector, matrix, or multidimensional array.

Data Types: fi

T — Input numericType object

scalar

Input numericType object, specified as a scalar.

See Also

isboolean | isdouble | isfixed | isfloat | isscaledtype | isscalingbinarypoint |
isscalingslopebias | isscalingunspecified | issingle

Introduced in R2008a

isscaledtype

Determine whether input is fixed-point or scaled double data type

Syntax

```
tf = isscaledtype(a)
tf = isscaledtype(T)
```

Description

`tf = isscaledtype(a)` returns 1 (true) when the `DataType` property of `fi` object `a` is `Fixed` or `ScaledDouble`. Otherwise, it returns 0 (false).

`tf = isscaledtype(T)` returns 1 (true) when the `DataType` property of `numericType` object `T` is `Fixed` or `ScaledDouble`. Otherwise, it returns 0 (false).

Examples

Determine Whether Input is Fixed-Point or Scaled Double Data Type

Create a `fi` object and determine whether its `DataType` property is set to `Fixed` or `ScaledDouble`.

```
a = fi([pi,pi/2]);
tf = isscaledtype(a)
```

```
tf = logical
    1
```

Create a `numericType` object and determine whether its `DataType` property is set to `Fixed` or `ScaledDouble`.

```
T1 = numericType('DataType','ScaledDouble');
tf = isscaledtype(T1)
```

```
tf = logical
    1
```

```
T2 = numericType('DataType','Single');
tf = isscaledtype(T2)
```

```
tf = logical
    0
```

Input Arguments

a — Input **fi** object

scalar | vector | matrix | multidimensional array

Input **fi** object, specified as a scalar, vector, matrix, or multidimensional array.

Data Types: **fi**

T — Input **numeric**type object

scalar

Input **numeric**type object, specified as a scalar.

See Also

[isboolean](#) | [isdouble](#) | [isfixed](#) | [isfloat](#) | [isscaleddouble](#) | [isscalingbinarypoint](#) | [isscalingslopebias](#) | [isscalingunspecified](#) | [issingle](#) | [numeric](#)type

Introduced in R2008a

isscalingbinarypoint

Determine whether input has binary point scaling

Syntax

```
tf = isscalingbinarypoint(a)
tf = isscalingbinarypoint(T)
```

Description

`tf = isscalingbinarypoint(a)` returns 1 (true) when the `fi` object `a` has binary point scaling or trivial slope and bias scaling. Otherwise, it returns 0 (false). Slope and bias scaling is trivial when the slope is an integer power of two and the bias is zero.

`tf = isscalingbinarypoint(T)` returns 1 (true) when the `numericType` object `T` has binary point scaling or trivial slope and bias scaling. Otherwise, it returns 0 (false).

Examples

Determine Whether Input has Binary Point Scaling

Create a `fi` object and determine whether it has binary point scaling.

```
a = fi(pi)
a =
    3.1416

    DataTypeMode: Fixed-point: binary point scaling
    Signedness: Signed
    WordLength: 16
    FractionLength: 13

tf = isscalingbinarypoint(a)
tf = logical
    1

b = fi(pi,1,16,3,2)
b =
    2

    DataTypeMode: Fixed-point: slope and bias scaling
    Signedness: Signed
    WordLength: 16
    Slope: 3
    Bias: 2

tf = isscalingbinarypoint(b)
```

```
tf = logical
    0
```

If the `fi` object has trivial slope and bias scaling, that is, the slope is an integer power of two and the bias is zero, `isscalingbinarypoint` returns 1.

```
c = fi(pi,1,16,4,0)
```

```
c =
    4
```

```
    DataTypeMode: Fixed-point: slope and bias scaling
    Signedness: Signed
    WordLength: 16
    Slope: 2^2
    Bias: 0
```

```
tf = isscalingbinarypoint(c)
```

```
tf = logical
    1
```

Create a `numerictype` object and determine whether it has binary point scaling.

```
T = numerictype
```

```
T =
```

```
    DataTypeMode: Fixed-point: binary point scaling
    Signedness: Signed
    WordLength: 16
    FractionLength: 15
```

```
tf = isscalingbinarypoint(T)
```

```
tf = logical
    1
```

Input Arguments

a — Input `fi` object

scalar | vector | matrix | multidimensional array

Input `fi` object, specified as a scalar, vector, matrix, or multidimensional array.

Data Types: `fi`

T — Input `numerictype` object

scalar

Input `numerictype` object, specified as a scalar.

See Also

`isboolean` | `isdouble` | `isfixed` | `isfloat` | `isscaleddouble` | `isscaledtype` |
`isscalingslopebias` | `isscalingunspecified` | `issingle`

Introduced in R2010b

isscalingslopebias

Determine whether input has nontrivial slope and bias scaling

Syntax

```
tf = isscalingslopebias(a)
tf = isscalingslopebias(T)
```

Description

`tf = isscalingslopebias(a)` returns 1 (true) when the `fi` object `a` has nontrivial slope and bias scaling. Otherwise, it returns 0 (false). Slope and bias scaling is trivial when the slope is an integer power of two and the bias is zero.

`tf = isscalingslopebias(T)` returns 1 (true) when the `numericType` object `T` has nontrivial slope and bias scaling. Otherwise, it returns 0 (false).

Examples

Determine Whether Input has Nontrivial Slope and Bias Scaling

Create a `fi` object and determine whether it has nontrivial slope and bias scaling.

```
a = fi(pi)
a =
    3.1416

    DataTypeMode: Fixed-point: binary point scaling
    Signedness: Signed
    WordLength: 16
    FractionLength: 13

tf = isscalingslopebias(a)
tf = logical
    0

b = fi(pi,1,16,3,1)
b =
    4

    DataTypeMode: Fixed-point: slope and bias scaling
    Signedness: Signed
    WordLength: 16
    Slope: 3
    Bias: 1

tf = isscalingslopebias(b)
```

```
tf = logical
    1
```

If the `fi` object has trivial slope and bias scaling, that is, the slope is an integer power of two and the bias is zero, `isscalingslopebias` returns 0.

```
c = fi(pi,1,16,4,0)
```

```
c =
    4
```

```
    DataTypeMode: Fixed-point: slope and bias scaling
    Signedness: Signed
    WordLength: 16
    Slope: 2^2
    Bias: 0
```

```
tf = isscalingslopebias(c)
```

```
tf = logical
    0
```

Create a `numerictype` object and determine whether it has nontrivial slope and bias scaling.

```
T = numerictype
```

```
T =
```

```
    DataTypeMode: Fixed-point: binary point scaling
    Signedness: Signed
    WordLength: 16
    FractionLength: 15
```

```
tf = isscalingslopebias(T)
```

```
tf = logical
    0
```

Input Arguments

a — Input `fi` object

scalar | vector | matrix | multidimensional array

Input `fi` object, specified as a scalar, vector, matrix, or multidimensional array.

Data Types: `fi`

T — Input `numerictype` object

scalar

Input `numerictype` object, specified as a scalar.

See Also

isboolean | isdouble | isfixed | isfloat | isscaleddouble | isscaledtype |
isscalingbinarypoint | isscalingunspecified | issingle

Introduced in R2010b

isscalingunspecified

Determine whether input has unspecified scaling

Syntax

```
tf = isscalingunspecified(a)
tf = isscalingunspecified(T)
```

Description

`tf = isscalingunspecified(a)` returns 1 (true) if fi object `a` has a fixed-point or scaled double data type and its scaling has not been specified.

`tf = isscalingunspecified(T)` returns 1 (true) if `numericType` object `T` has a fixed-point or scaled double data type and its scaling has not been specified.

Examples

Determine Whether Input has Unspecified Scaling

Create a `numericType` object and determine whether it has unspecified scaling.

```
T1 = numericType(0)
```

```
T1 =
```

```
      DataTypeMode: Fixed-point: unspecified scaling
      Signedness:   Unsigned
      WordLength:   16
```

```
tf = isscalingunspecified(T1)
```

```
tf = logical
     1
```

```
T2 = numericType(0,24,12,'DataType','ScaledDouble')
```

```
T2 =
```

```
      DataTypeMode: Scaled double: binary point scaling
      Signedness:   Unsigned
      WordLength:   24
      FractionLength: 12
```

```
tf = isscalingunspecified(T2)
```

```
tf = logical
     0
```

Create a `fi` object and determine whether it has unspecified scaling.

```
a = fi(pi,1)
a =
    3.1416

    DataTypeMode: Fixed-point: binary point scaling
    Signedness: Signed
    WordLength: 16
    FractionLength: 13

tf = isscalingunspecified(a)

tf = logical
    0
```

Input Arguments

a — Input `fi` object

scalar | vector | matrix | multidimensional array

Input `fi` object, specified as a scalar, vector, matrix, or multidimensional array.

Data Types: `fi`

T — Input `numericType` object

scalar

Input `numericType` object, specified as a scalar.

See Also

`isboolean` | `isdouble` | `isfixed` | `isfloat` | `isscaleddouble` | `isscaledtype` | `isscalingbinarypoint` | `isscalingslopebias` | `issingle`

Introduced in R2010b

issigned

Determine whether `fi` object is signed

Syntax

```
tf = issigned(a)
```

Description

`tf = issigned(a)` returns 1 (true) if the `fi` object `a` is signed. Otherwise, it returns 0 (false).

Examples

Determine Whether `fi` Object is Signed

Create a `fi` object and determine whether it is signed or unsigned.

```
a1 = fi(pi,1)
```

```
a1 =  
    3.1416
```

```
        DataTypeMode: Fixed-point: binary point scaling  
        Signedness: Signed  
        WordLength: 16  
        FractionLength: 13
```

```
tf = issigned(a1)
```

```
tf = logical  
    1
```

```
a2 = fi(pi,0)
```

```
a2 =  
    3.1416
```

```
        DataTypeMode: Fixed-point: binary point scaling  
        Signedness: Unsigned  
        WordLength: 16  
        FractionLength: 14
```

```
tf = issigned(a2)
```

```
tf = logical  
    0
```

If a `numerictype` object with `Auto Signedness` is used to create a `fi` object, the `Signedness` property of the `fi` object automatically defaults to `Signed`.

```
T = numerictype('Signedness','Auto')
```

```

T =

    DataTypeMode: Fixed-point: binary point scaling
    Signedness: Auto
    WordLength: 16
    FractionLength: 15

a3 = fi(pi,T)

a3 =
    1.0000

    DataTypeMode: Fixed-point: binary point scaling
    Signedness: Signed
    WordLength: 16
    FractionLength: 15

tf = issigned(a3)

tf = logical
    1

```

Input Arguments

a — Input **fi** object

scalar | vector | matrix | multidimensional array

Input **fi** object, specified as a scalar, vector, matrix, or multidimensional array.

Data Types: **fi**

Extended Capabilities

C/C++ Code Generation

Generate C and C++ code using MATLAB® Coder™.

HDL Code Generation

Generate Verilog and VHDL code for FPGA and ASIC designs using HDL Coder™.

See Also

[isfi](#) | [isfixed](#) | [isscaledouble](#) | [isscaledtype](#) | [isscalingbinarypoint](#) | [isscalingslopebias](#) | [isscalingunspecified](#)

Introduced before R2006a

issingle

Determine whether input is single-precision data type

Syntax

```
tf = issingle(a)
tf = issingle(T)
```

Description

`tf = issingle(a)` returns 1 (true) when the `DataType` property of `fi` object `a` is `single`. Otherwise, it returns 0 (false).

`tf = issingle(T)` returns 1 (true) when the `DataType` property of `numericType` object `T` is `single`. Otherwise, it returns 0 (false).

Examples

Determine Whether Input is Single-Precision Data Type

Create a `fi` object and determine whether it is single-precision data type.

```
a = fi(pi)
a =
    3.1416

        DataTypeMode: Fixed-point: binary point scaling
          Signedness: Signed
         WordLength: 16
    FractionLength: 13

tf = issingle(a)
tf = logical
    0
```

Create a `numericType` object and determine whether it is single-precision data type.

```
T = numericType('Single')
T =

        DataTypeMode: Single

tf = issingle(T)
tf = logical
    1
```

Input Arguments

a — Input `fi` object

scalar | vector | matrix | multidimensional array

Input `fi` object, specified as a scalar, vector, matrix, or multidimensional array.

Data Types: `fi`

T — Input `numericType` object

scalar

Input `numericType` object, specified as a scalar.

See Also

`isboolean` | `isdouble` | `isfixed` | `isfloat` | `isscaleddouble` | `isscaledtype` | `isscalingbinarypoint` | `isscalinglopbias` | `isscalingunspecified`

Introduced in R2008a

isslopebiasscaled

Determine whether numeric type object has nontrivial slope and bias scaling

Syntax

```
tf = isslopebiasscaled(T)
```

Description

`tf = isslopebiasscaled(T)` returns 1 (true) when numeric type `T` has nontrivial slope and bias scaling. Otherwise, it returns 0 (false). Slope and bias scaling is trivial when the slope is an integer power of two and the bias is zero.

Examples

Determine Whether numeric type Object has Nontrivial Slope and Bias Scaling

Create a numeric type object and determine whether it has nontrivial slope and bias scaling.

```
T1 = numerictype
```

```
T1 =
```

```
      DataTypeMode: Fixed-point: binary point scaling
      Signedness: Signed
      WordLength: 16
      FractionLength: 15
```

```
tf = isslopebiasscaled(T1)
```

```
tf = logical
    0
```

```
T2 = numerictype('DataTypeMode','Fixed-point: slope and bias scaling',...
    'WordLength', 32, 'Slope', 2^-2, 'Bias', 4)
```

```
T2 =
```

```
      DataTypeMode: Fixed-point: slope and bias scaling
      Signedness: Signed
      WordLength: 32
      Slope: 0.25
      Bias: 4
```

```
tf = isslopebiasscaled(T2)
```

```
tf = logical
    1
```

```
T3 = numerictype('DataTypeMode','Fixed-point: slope and bias scaling',...  
  'WordLength', 32, 'Slope', 2^2, 'Bias', 0)
```

```
T3 =
```

```
    DataTypeMode: Fixed-point: slope and bias scaling  
    Signedness: Signed  
    WordLength: 32  
    Slope: 2^2  
    Bias: 0
```

```
tf = isslopebiasscaled(T3)
```

```
tf = logical  
    0
```

Input Arguments

T — Input `numerictype` object

scalar

Input `numerictype` object, specified as a scalar.

See Also

`isboolean` | `isdouble` | `isfixed` | `isfloat` | `isscaleddouble` | `isscaledtype` | `issingle` | `numerictype`

Introduced in R2008a

le

Determine whether real-world value of `fi` object is less than or equal to another

Syntax

```
c = le(a,b)
a <= b
```

Description

`c = le(a,b)` is called for the syntax `a <= b` when `a` or `b` is a `fi` object. `a` and `b` must have the same dimensions unless one is a scalar. A scalar can be compared with another object of any size.

`a <= b` does an element-by-element comparison between `a` and `b` and returns a matrix of the same size with elements set to 1 where the relation is true, and 0 where the relation is false.

In relational operations comparing a floating-point value to a fixed-point value, the floating-point value is cast to the same word length and signedness as the `fi` object, with best-precision scaling.

Examples

Compare Two `fi` Objects

Use the `le` function to determine whether the real-world value of one `fi` object is less than or equal to another.

```
a = fi(pi);
b = fi(pi, 1, 32);
a <= b
```

```
ans = logical
      0
```

Input `a` has a 16-bit word length, while input `b` has a 32-bit word length. The `le` function returns 0 because after quantization, the value of `a` is greater than that of `b`.

Compare a Double to a `fi` Object

When comparing a double to a `fi` object, the double is cast to the same word length and signedness of the `fi` object.

```
a = fi(pi);
b = pi;
a <= b
```



```
ans = logical  
     1
```

The `le` function casts `b` to the same word length as `a`, and returns `1` because the two inputs have the same real-world value. This behavior allows relational operations to work between `fi` objects and floating-point constants without introducing floating-point values in generated code.

Extended Capabilities

C/C++ Code Generation

Generate C and C++ code using MATLAB® Coder™.

Usage notes and limitations:

- Fixed-point signals with different biases are not supported.

HDL Code Generation

Generate Verilog and VHDL code for FPGA and ASIC designs using HDL Coder™.

See Also

`eq` | `ge` | `gt` | `lt` | `ne`

Introduced before R2006a

logreport

Quantization report

Syntax

```
logreport(a)
logreport(a, b, ...)
```

Description

`logreport(a)` displays the `minlog`, `maxlog`, `lowerbound`, `upperbound`, `noverflows`, and `nunderflows` for the `fi` object `a`.

`logreport(a, b, ...)` displays the report for each `fi` object `a`, `b`, ...

Examples

The following example produces a `logreport` for `fi` objects `a` and `b`:

```
fipref('LoggingMode','On');
a = fi(pi);
b = fi(randn(10),1,8,7);
```

```
Warning: 35 overflow(s) occurred in the fi assignment operation.
> In embedded.fi/fifactory
In fi (line 226)
Warning: 2 underflow(s) occurred in the fi assignment operation.
> In embedded.fi/fifactory
In fi (line 226)
```

```
logreport(a,b)
```

```
logreport(a,b)
```

	minlog	maxlog	lowerbound	upperbound	noverflows	nunderflows
a	3.141602	3.141602	-4	3.999878	0	0
b	-1	0.9921875	-1	0.9921875	35	2

See Also

[fipref](#) | [quantize](#) | [quantizer](#)

Introduced in R2008a

lowerbound

Lower bound of range of `fi` object

Syntax

`lowerbound(a)`

Description

`lowerbound(a)` returns the lower bound of the range of `fi` object `a`. If `L=lowerbound(a)` and `U=upperbound(a)`, then `[L,U]=range(a)`.

Extended Capabilities

C/C++ Code Generation

Generate C and C++ code using MATLAB® Coder™.

HDL Code Generation

Generate Verilog and VHDL code for FPGA and ASIC designs using HDL Coder™.

See Also

`eps` | `intmax` | `intmin` | `lsb` | `range` | `realmax` | `realmin` | `upperbound`

Introduced before R2006a

lsb

Scaling of least significant bit of `fi` object, or value of least significant bit of `quantizer` object

Syntax

```
b = lsb(a)
p = lsb(q)
```

Description

`b = lsb(a)` returns the scaling of the least significant bit of `fi` object `a`. The result is equivalent to the result given by the `eps` function.

`p = lsb(q)` returns the quantization level of `quantizer` object `q`, or the distance from `1.0` to the next largest floating-point number if `q` is a floating-point `quantizer` object.

Examples

This example uses the `lsb` function to find the value of the least significant bit of the `quantizer` object `q`.

```
q = quantizer('fixed',[8 7]);
p = lsb(q)

p =

    0.0078
```

Extended Capabilities

C/C++ Code Generation

Generate C and C++ code using MATLAB® Coder™.

Usage notes and limitations:

- Code generation supports scalar fixed-point signals only.
- Code generation supports scalar, vector, and matrix, `fi` single and double signals.

HDL Code Generation

Generate Verilog and VHDL code for FPGA and ASIC designs using HDL Coder™.

See Also

`eps` | `intmax` | `intmin` | `lowerbound` | `quantize` | `range` | `realmax` | `realmin` | `upperbound`

Introduced before R2006a

lt

Determine whether real-world value of one `fi` object is less than another

Syntax

```
c = lt(a,b)
a < b
```

Description

`c = lt(a,b)` is called for the syntax `a < b` when `a` or `b` is a `fi` object. `a` and `b` must have the same dimensions unless one is a scalar. A scalar can be compared with another object of any size.

`a < b` does an element-by-element comparison between `a` and `b` and returns a matrix of the same size with elements set to 1 where the relation is true, and 0 where the relation is false.

In relational operations comparing a floating-point value to a fixed-point value, the floating-point value is cast to the same word length and signedness as the `fi` object, with best-precision scaling.

Examples

Compare Two `fi` Objects

Use the `lt` function to determine whether the real-world value of one `fi` object is less than another.

```
a = fi(pi);
b = fi(pi, 1, 32);
a < b

ans = logical
     0
```

Input `a` has a 16-bit word length, while input `b` has a 32-bit word length. The `lt` function returns 0 because after quantization, the value of `a` is greater than that of `b`.

Compare a Double to a `fi` Object

When comparing a double to a `fi` object, the double is cast to the same word length and signedness of the `fi` object.

```
a = fi(pi);
b = pi;
a < b

ans = logical
     0
```

The `lt` function casts `b` to the same word length as `a`, and returns `0` because the two inputs have the same real-world value. This behavior allows relational operations to work between `fi` objects and floating-point constants without introducing floating-point values in generated code.

Extended Capabilities

C/C++ Code Generation

Generate C and C++ code using MATLAB® Coder™.

Usage notes and limitations:

- Fixed-point signals with different biases are not supported.

HDL Code Generation

Generate Verilog and VHDL code for FPGA and ASIC designs using HDL Coder™.

See Also

`eq` | `ge` | `gt` | `le` | `ne`

Introduced before R2006a

mat2str

Convert matrix to string

Syntax

```
str = mat2str(A)
str = mat2str(A, n)
str = mat2str(A, 'class')
str = mat2str(A, n, 'class')
```

Description

`str = mat2str(A)` converts `fi` object `A` to a string representation. The output is suitable for input to the `eval` function such that `eval(str)` produces the original `fi` object exactly.

`str = mat2str(A, n)` converts `fi` object `A` to a string representation using `n` bits of precision.

`str = mat2str(A, 'class')` creates a string representation with the name of the class of `A` included. This option ensures that the result of evaluating `str` will also contain the class information.

`str = mat2str(A, n, 'class')` uses `n` bits of precision and includes the class of `A`.

Examples

Convert `fi` Object to a String

Convert the `fi` object `a` to a string.

```
a = fi(pi);
str = mat2str(a)
```

```
str =
'3.1416015625'
```

Convert `fi` Object to a String with Specified Precision

Convert the `fi` object `a` to a string using eight bits of precision.

```
a = fi(pi);
str = mat2str(a, 8)
```

```
str =
'3.1416016'
```

Input Arguments

A — Input array

scalar | vector | matrix

Input array, specified as a scalar, vector, or matrix. A cannot be a multidimensional array.

Data Types: fi|single | double | int8 | int16 | int32 | int64 | uint8 | uint16 | uint32 | uint64

n — Number of bits of precision

positive integer

Number of bits of precision in the output, specified as a positive integer.

Data Types: single | double | int8 | int16 | int32 | int64 | uint8 | uint16 | uint32 | uint64

Output Arguments

str — String representation of input array

character array

String representation of input array, returned as a character array.

See Also

mat2str | tostring

Introduced in R2015b

max

Largest element in array of `fi` objects

Syntax

```
x = max(a)
x = max(a, [], dim)
[x, y] = max( ___ )
m = max(a, b)
```

Description

`x = max(a)` returns the largest elements along different dimensions of `fi` array `a`.

If `a` is a vector, `max(a)` returns the largest element in `a`.

If `a` is a matrix, `max(a)` treats the columns of `a` as vectors, returning a row vector containing the maximum element from each column.

If `a` is a multidimensional array, `max` operates along the first nonsingleton dimension and returns an array of maximum values.

`x = max(a, [], dim)` returns the largest elements along dimension `dim`.

`[x, y] = max(___)` finds the indices of the maximum values and returns them in array `y`, using any of the input arguments in the previous syntaxes. If the largest value occurs multiple times, the index of the first occurrence is returned.

`m = max(a, b)` returns an array the same size as `a` and `b` with the largest elements taken from `a` or `b`.

Examples

Largest Element in a Vector

Create a fixed-point vector, and return the maximum value from the vector.

```
a = fi([1,5,4,9,2],1,16);
x = max(a)
```

```
x =
     9
```

```
    DataTypeMode: Fixed-point: binary point scaling
    Signedness: Signed
    WordLength: 16
    FractionLength: 11
```

Largest Element of Each Matrix Row

Create a fixed-point matrix.

```
a = fi(magic(4),1,16)
```

```
a=4x4 object
```

```
16     2     3     13
 5     11    10     8
 9     7     6     12
 4     14    15     1
```

```
        DataTypeMode: Fixed-point: binary point scaling
          Signedness: Signed
          WordLength: 16
        FractionLength: 10
```

Find the largest element of each row by finding the maximum values along the second dimension.

```
x = max(a,[],2)
```

```
x=4x1 object
```

```
16
11
12
15
```

```
        DataTypeMode: Fixed-point: binary point scaling
          Signedness: Signed
          WordLength: 16
        FractionLength: 10
```

The output vector, x , is a column vector that contains the largest element of each row.

Largest Element of Each Matrix Column

Create a fixed-point matrix.

```
a = fi(magic(4),1,16)
```

```
a=4x4 object
```

```
16     2     3     13
 5     11    10     8
 9     7     6     12
 4     14    15     1
```

```
        DataTypeMode: Fixed-point: binary point scaling
          Signedness: Signed
          WordLength: 16
        FractionLength: 10
```

Find the largest element of each column.

```
x = max(a)
```

```
x=1x4 object
    16    14    15    13

    DataTypeMode: Fixed-point: binary point scaling
    Signedness: Signed
    WordLength: 16
    FractionLength: 10
```

The output, *x*, is a row vector that contains the largest elements from each column of *a*.

Find the index of each of the maximum elements.

```
[x,y] = max(a)
```

```
x=1x4 object
    16    14    15    13

    DataTypeMode: Fixed-point: binary point scaling
    Signedness: Signed
    WordLength: 16
    FractionLength: 10
```

```
y = 1x4
```

```
    1    4    4    1
```

Vector *y* contains the indices to the minimum elements in *x*.

Maximum Elements from Two Arrays

Create two fixed-point arrays of the same size.

```
a = fi([2.3,4.7,6;0,7,9.23],1,16);
b = fi([9.8,3.21,1.6;pi,2.3,1],1,16);
```

Find the largest elements from *a* or *b*.

```
m = max(a,b)
```

```
m=2x3 object
    9.7998    4.7002    6.0000
    3.1416    7.0000    9.2300

    DataTypeMode: Fixed-point: binary point scaling
    Signedness: Signed
    WordLength: 16
    FractionLength: 11
```

m contains the largest elements from each pair of corresponding elements in *a* and *b*.

Largest Element of a Complex Vector

Create a complex fixed-point vector, **a**.

```
a = fi([1+2i,3+6i,6+3i,2-4i],1,16)
```

```
a=1x4 object
  1.0000 + 2.0000i   3.0000 + 6.0000i   6.0000 + 3.0000i   2.0000 - 4.0000i

      DataTypeMode: Fixed-point: binary point scaling
      Signedness: Signed
      WordLength: 16
      FractionLength: 12
```

The function finds the largest element of a complex vector by taking the element with the largest magnitude.

```
abs(a)
```

```
ans=1x4 object
  2.2361   6.7083   6.7083   4.4722

      DataTypeMode: Fixed-point: binary point scaling
      Signedness: Signed
      WordLength: 16
      FractionLength: 12
```

In vector **a**, the largest elements, at position 2 and 3, have a magnitude of **6.7083**. The **max** function returns the largest element in output **x** and the index of that element in output **y**.

```
[x,y] = max(a)
```

```
x =
  3.0000 + 6.0000i

      DataTypeMode: Fixed-point: binary point scaling
      Signedness: Signed
      WordLength: 16
      FractionLength: 12
```

```
y = 2
```

Although the elements at index 2 and 3 have the same magnitude, the index of the first occurrence of that value is always returned.

Input Arguments

a — Input **fi** array

fi object | numeric variable

fi input array, specified as a scalar, vector, matrix, or multidimensional array. The dimensions of **a** and **b** must match unless one is a scalar.

The **max** function ignores NaNs.

Data Types: `fi|single | double | int8 | int16 | int32 | int64 | uint8 | uint16 | uint32 | uint64`

Complex Number Support: Yes

b — Second input fi array

`fi object | numeric variable`

Second `fi` input array, specified as a scalar, vector, matrix, or multidimensional array. The dimensions of `a` and `b` must match unless one is a scalar.

The `max` function ignores NaNs.

Data Types: `fi|single | double | int8 | int16 | int32 | int64 | uint8 | uint16 | uint32 | uint64`

Complex Number Support: Yes

dim — dimension to operate along

`positive integer scalar`

Dimension to operate along, specified as a positive integer scalar. `dim` can also be a `fi` object. If you do not specify a value, the default value is the first array dimension whose size does not equal 1.

Data Types: `fi|single | double | int8 | int16 | int32 | int64 | uint8 | uint16 | uint32 | uint64`

Output Arguments

x — Maximum values

`scalar | vector | matrix | multidimensional array`

Maximum values, returned as a scalar, vector, matrix, or multidimensional array. `x` always has the same data type as the input.

y — Index of maximum values

`scalar | vector | matrix | multidimensional array`

Indices of the maximum values in array `x`, returned as a scalar, vector, matrix, or multidimensional array. If the largest value occurs more than once, then `y` contains the index to the first occurrence of the value. `y` is always of data type `double`.

m — Array of maximum values

`scalar | vector | matrix | multidimensional array`

Array of maximum values of `a` and `b`, returned as a scalar, vector, matrix, or multidimensional array.

Algorithms

When `a` or `b` is complex, the `max` function returns the elements with the largest magnitude. If two magnitudes are equal, then `max` returns the first value. This behavior differs from how the builtin `max` function resolves ties between complex numbers.

Extended Capabilities

C/C++ Code Generation

Generate C and C++ code using MATLAB® Coder™.

HDL Code Generation

Generate Verilog and VHDL code for FPGA and ASIC designs using HDL Coder™.

See Also

`mean` | `median` | `min` | `sort`

Introduced before R2006a

maxlog

Log maximums

Syntax

```
y = maxlog(a)
y = maxlog(q)
```

Description

`y = maxlog(a)` returns the largest real-world value of `fi` object `a` since logging was turned on or since the last time the log was reset for the object.

Turn on logging by setting the `fipref` object `LoggingMode` property to `on`. Reset logging for a `fi` object using the `resetlog` function.

`y = maxlog(q)` is the maximum value after quantization during a call to `quantize(q, ...)` for quantizer object `q`. This value is the maximum value encountered over successive calls to `quantize` since logging was turned on, and is reset with `resetlog(q)`. `maxlog(q)` is equivalent to `get(q, 'maxlog')` and `q.maxlog`.

Examples

Example 1: Using maxlog with fi objects

```
1 P = fipref('LoggingMode','on');
   format long g
   a = fi([-1.5 eps 0.5], true, 16, 15);
   a(1) = 3.0;
   maxlog(a)
```

```
Warning: 1 overflow(s) occurred in the fi assignment operation.
> In embedded.fi/fifactory
In fi (line 226)
Warning: 1 underflow(s) occurred in the fi assignment operation.
> In embedded.fi/fifactory
In fi (line 226)
Warning: 1 overflow(s) occurred in the fi assignment operation.
```

```
ans =
```

```
0.999969482421875
```

The largest value `maxlog` can return is the maximum representable value of its input. In this example, `a` is a signed `fi` object with word length 16, fraction length 15 and range:

$$-1 \leq x \leq 1 - 2^{-15} \quad (4-10)$$

2 You can obtain the numerical range of any `fi` object `a` using the `range` function:

```
format long g
r = range(a)

r =

           -1           0.999969482421875

      DataTypeMode: Fixed-point: binary point scaling
      Signedness: Signed
      WordLength: 16
      FractionLength: 15
```

Example 2: Using maxlog with quantizer objects

```
1 q = quantizer;
  warning on
  format long g
  x = [-20:10];
  y = quantize(q,x);
  maxlog(q)

Warning: 29 overflow(s) occurred in the fi quantize operation.
> In embedded.quantizer/quantize (line 81)

ans =

           0.999969482421875
```

The largest value maxlog can return is the maximum representable value of its input.

- 2 You can obtain the range of x after quantization using the range function:

```
format long g
r = range(q)

r =

           -1           0.999969482421875
```

See Also

fipref | minlog | noverflows | nunderflows | reset | resetlog

Introduced before R2006a

mean

Average or mean value of fixed-point array

Syntax

```
M = mean(A)
M = mean(A,dim)
```

Description

`M = mean(A)` computes the mean value of the real-valued fixed-point array `A` along its first nonsingleton dimension.

`M = mean(A,dim)` computes the mean value of the real-valued fixed-point array `A` along dimension `dim`. `dim` must be a positive, real-valued integer with a power-of-two slope and a bias of 0.

The fixed-point output array, `M`, has the same `numericType` properties as the fixed-point input array, `A`.

If the input array, `A`, has a local `fimath`, then it is used for intermediate calculations. The output, `M`, is always associated with the default `fimath`.

When `A` is an empty fixed-point array (value = `[]`), the value of the output array is zero.

Examples

Mean Along Columns of Fixed-Point Array

Create a matrix and compute the mean of each column. `A` is a signed `fi` object with a 32-bit word length and a best-precision fraction length of 28 bits.

```
A = fi([0 1 2; 3 4 5],1,32);
M = mean(A)
```

`A =`

```
    0     1     2
    3     4     5
```

```
      DataTypeMode: Fixed-point: binary point scaling
      Signedness: Signed
      WordLength: 32
      FractionLength: 28
```

`M =`

```
    1.5000    2.5000    3.5000
```

```
      DataTypeMode: Fixed-point: binary point scaling
      Signedness: Signed
```

```
WordLength: 32
FractionLength: 28
```

Mean Along Rows of Fixed-Point Array

Create a matrix and compute the mean of each row. A is a signed `fi` object with a 32-bit word length and a best-precision fraction length of 28 bits.

```
A = fi([0 1 2; 3 4 5],1,32)
M = mean(A,2)
```

A =

```
0    1    2
3    4    5
```

```
DataTypeMode: Fixed-point: binary point scaling
Signedness: Signed
WordLength: 32
FractionLength: 28
```

M =

```
1
4
```

```
DataTypeMode: Fixed-point: binary point scaling
Signedness: Signed
WordLength: 32
FractionLength: 28
```

Input Arguments

A — Input array

vector | matrix | multidimensional array

Input array, specified as a vector, matrix, or multidimensional array.

- If A is a scalar, then `mean(A)` returns A.
- If A is an empty fixed-point array (value = `[]`), the value of the output array is zero.

Data Types: `fi`

dim — Dimension to operate along

positive integer scalar

Dimension to operate along, specified as a positive, real-valued, integer scalar with a power-of-two slope and a bias of 0. If no value is specified, then the default is the first array dimension whose size does not equal 1.

Data Types: `single` | `double` | `int8` | `int16` | `int32` | `int64` | `uint8` | `uint16` | `uint32` | `uint64` | `fi`

Algorithms

The general equation for computing the mean of an array `A`, across dimension `dim` is:

```
sum(A,dim)/size(A,dim)
```

Because `size(a,dim)` is always a positive integer, the algorithm for computing mean casts `size(A,dim)` to an unsigned 32-bit `fi` object with a fraction length of zero (denote this `fi` object 'SizeA'). The algorithm then computes the mean of `A` according to the following equation, where `Tx` represents the `numericType` properties of the fixed-point input array `A`:

```
c = Tx.divide(sum(A,dim), SizeA)
```

Extended Capabilities

C/C++ Code Generation

Generate C and C++ code using MATLAB® Coder™.

See Also

`max` | `median` | `min`

Introduced in R2010a

median

Median value of fixed-point array

Syntax

```
c = median(a)
c = median(a, dim)
```

Description

`c = median(a)` computes the median value of the fixed-point array *a* along its first nonsingleton dimension.

`c = median(a, dim)` computes the median value of the fixed-point array *a* along dimension *dim*. *dim* must be a positive, real-valued integer with a power-of-two slope and a bias of 0.

The input to the `median` function must be a real-valued fixed-point array.

The fixed-point output array *c* has the same `numericType` properties as the fixed-point input array *a*. If the input, *a*, has a local `fimath`, then it is used for intermediate calculations. The output, *c*, is always associated with the default `fimath`.

When *a* is an empty fixed-point array (value = `[]`), the value of the output array is zero.

Examples

Compute the median value along the first dimension of a fixed-point array.

```
x = fi([0 1 2; 3 4 5; 7 2 2; 6 4 9], 1, 32)
% x is a signed FI object with a 32-bit word length
% and a best-precision fraction length of 27 bits
mx1 = median(x,1)
```

Compute the median value along the second dimension (columns) of a fixed-point array.

```
x = fi([0 1 2; 3 4 5; 7 2 2; 6 4 9], 1, 32)
% x is a signed FI object with a 32-bit word length
% and a best-precision fraction length of 27 bits
mx2 = median(x, 2)
```

Extended Capabilities

C/C++ Code Generation

Generate C and C++ code using MATLAB® Coder™.

See Also

`max` | `mean` | `min`

Introduced in R2010a

min

Smallest element in array of `fi` objects

Syntax

```
x = min(a)
x = min(a,[],dim)
[x,y] = min( ___ )
m = min(a,b)
```

Description

`x = min(a)` returns the smallest elements along different dimensions of `fi` array `a`.

If `a` is a vector, `min(a)` returns the smallest element in `a`.

If `a` is a matrix, `min(a)` treats the columns of `a` as vectors, returning a row vector containing the minimum element from each column.

If `a` is a multidimensional array, `min` operates along the first nonsingleton dimension and returns an array of minimum values.

`x = min(a,[],dim)` returns the smallest elements along dimension `dim`.

`[x,y] = min(___)` finds the indices of the minimum values and returns them in array `y`, using any of the input arguments in the previous syntaxes. If the smallest value occurs multiple times, the index of the first occurrence is returned.

`m = min(a,b)` returns an array the same size as `a` and `b` with the smallest elements taken from `a` or `b`.

Examples

Smallest Element in a Vector

Create a fixed-point vector, and return the minimum value from the vector.

```
a = fi([1,5,4,9,2],1,16);
x = min(a)
```

```
x =
    1
```

```
    DataTypeMode: Fixed-point: binary point scaling
    Signedness: Signed
    WordLength: 16
    FractionLength: 11
```

Minimum Element of Each Matrix Row

Create a matrix of fixed-point values.

```
a = fi(magic(4),1,16)
```

```
a=4x4 object
```

```
16    2    3    13
 5   11   10    8
 9    7    6   12
 4   14   15    1
```

```
      DataTypeMode: Fixed-point: binary point scaling
      Signedness: Signed
      WordLength: 16
      FractionLength: 10
```

Find the smallest element of each row by finding the minimum values along the second dimension.

```
x = min(a,[],2)
```

```
x=4x1 object
```

```
2
5
6
1
```

```
      DataTypeMode: Fixed-point: binary point scaling
      Signedness: Signed
      WordLength: 16
      FractionLength: 10
```

The output, *x*, is a column vector that contains the smallest element of each row of *a*.

Minimum Element of Each Matrix Column

Create a fixed-point matrix.

```
a = fi(magic(4),1,16)
```

```
a=4x4 object
```

```
16    2    3    13
 5   11   10    8
 9    7    6   12
 4   14   15    1
```

```
      DataTypeMode: Fixed-point: binary point scaling
      Signedness: Signed
      WordLength: 16
      FractionLength: 10
```

Find the smallest element of each column.

```
x = min(a)
```

```
x=1x4 object
  4     2     3     1
      DataTypeMode: Fixed-point: binary point scaling
      Signedness: Signed
      WordLength: 16
      FractionLength: 10
```

The output, *x*, is a row vector that contains the smallest element of each column of *a*.

Find the index of each of the minimum elements.

```
[x,y] = min(a)
```

```
x=1x4 object
  4     2     3     1
      DataTypeMode: Fixed-point: binary point scaling
      Signedness: Signed
      WordLength: 16
      FractionLength: 10
```

```
y = 1x4
     4     1     1     4
```

Minimum Elements from Two Arrays

Create two fixed-point arrays of the same size.

```
a = fi([2.3,4.7,6;0,7,9.23],1,16);
b = fi([9.8,3.21,1.6;pi,2.3,1],1,16);
```

Find the minimum elements from *a* or *b*.

```
m = min(a,b)
m=2x3 object
  2.2998    3.2100    1.6001
     0     2.2998    1.0000
      DataTypeMode: Fixed-point: binary point scaling
      Signedness: Signed
      WordLength: 16
      FractionLength: 11
```

m contains the smallest elements from each pair of corresponding elements in *a* and *b*.

Minimum Element of a Complex Vector

Create a complex fixed-point vector, **a**.

```
a = fi([1+2i,2+i,3+8i,9+i],1,8)
```

```
a=1x4 object
  1.0000 + 2.0000i   2.0000 + 1.0000i   3.0000 + 8.0000i   9.0000 + 1.0000i

      DataTypeMode: Fixed-point: binary point scaling
      Signedness: Signed
      WordLength: 8
      FractionLength: 3
```

The function finds the smallest element of a complex vector by taking the element with the smallest magnitude.

```
abs(a)
```

```
ans=1x4 object
  2.2500   2.2500   8.5000   9.0000

      DataTypeMode: Fixed-point: binary point scaling
      Signedness: Signed
      WordLength: 8
      FractionLength: 3
```

In vector **a**, the smallest elements, at position 1 and 2, have a magnitude of 2.25. The `min` function returns the smallest element in output **x**, and the index of that element in output, **y**.

```
[x,y] = min(a)
```

```
x =
  1.0000 + 2.0000i

      DataTypeMode: Fixed-point: binary point scaling
      Signedness: Signed
      WordLength: 8
      FractionLength: 3
```

```
y = 1
```

Although the elements at index 1 and 2 have the same magnitude, the index of the first occurrence of that value is always returned.

Input Arguments

a — Input **fi** array

`fi` object | numeric variable

fi input array, specified as a scalar, vector, matrix, or multidimensional array. The dimensions of **a** and **b** must match unless one is a scalar.

The `min` function ignores NaNs.

Data Types: `fi|single | double | int8 | int16 | int32 | int64 | uint8 | uint16 | uint32 | uint64`

Complex Number Support: Yes

b — Second input fi array

`fi object | numeric variable`

Second `fi` input array, specified as a scalar, vector, matrix, or multidimensional array. The dimensions of `a` and `b` must match unless one is a scalar.

The `min` function ignores NaNs.

Data Types: `fi|single | double | int8 | int16 | int32 | int64 | uint8 | uint16 | uint32 | uint64`

Complex Number Support: Yes

dim — dimension to operate along

`positive integer scalar`

Dimension to operate along, specified as a positive integer scalar. `dim` can also be a `fi` object. If you do not specify a value, the default value is the first array dimension whose size does not equal 1.

Data Types: `fi|single | double | int8 | int16 | int32 | int64 | uint8 | uint16 | uint32 | uint64`

Output Arguments

x — Minimum values

`scalar | vector | matrix | multidimensional array`

Minimum values, returned as a scalar, vector, matrix, or multidimensional array. `x` always has the same data type as the input.

y — Index of minimum values

`scalar | vector | matrix | multidimensional array`

Indices of the minimum values in array `x`, returned as a scalar, vector, matrix, or multidimensional array. If the smallest value occurs more than once, then `y` contains the index to the first occurrence of the value. `y` is always of data type `double`.

m — Array of minimum values

`scalar | vector | matrix | multidimensional array`

Array of minimum values of `a` and `b`, returned as a scalar, vector, matrix, or multidimensional array.

Algorithms

When `a` or `b` is complex, the `min` function returns the element with the smallest magnitude. If two magnitudes are equal, then `min` returns the first value. This behavior differs from how the builtin `min` function resolves ties between complex numbers.

Extended Capabilities

C/C++ Code Generation

Generate C and C++ code using MATLAB® Coder™.

HDL Code Generation

Generate Verilog and VHDL code for FPGA and ASIC designs using HDL Coder™.

See Also

`max` | `mean` | `median` | `sort`

Introduced before R2006a

minlog

Log minimums

Syntax

```
y = minlog(a)
y = minlog(q)
```

Description

`y = minlog(a)` returns the smallest real-world value of `fi` object `a` since logging was turned on or since the last time the log was reset for the object.

Turn on logging by setting the `fipref` object `LoggingMode` property to `on`. Reset logging for a `fi` object using the `resetlog` function.

`y = minlog(q)` is the minimum value after quantization during a call to `quantize(q, ...)` for quantizer object `q`. This value is the minimum value encountered over successive calls to `quantize` since logging was turned on, and is reset with `resetlog(q)`. `minlog(q)` is equivalent to `get(q, 'minlog')` and `q.minlog`.

Examples

Example 1: Using minlog with fi objects

```
1 P = fipref('LoggingMode','on');
  a = fi([-1.5 eps 0.5], true, 16, 15);
  a(1) = 3.0;
  minlog(a)
```

```
Warning: 1 overflow(s) occurred in the fi assignment operation.
> In embedded.fi/fifactory
In fi (line 226)
Warning: 1 underflow(s) occurred in the fi assignment operation.
> In embedded.fi/fifactory
In fi (line 226)
Warning: 1 overflow(s) occurred in the fi assignment operation.
```

```
ans =
```

```
-1
```

The smallest value `minlog` can return is the minimum representable value of its input. In this example, `a` is a signed `fi` object with word length 16, fraction length 15 and range:

$$-1 \leq x \leq 1 - 2^{-15} \quad (4-11)$$

2 You can obtain the numerical range of any `fi` object `a` using the `range` function:

```
format long g
r = range(a)
```

```
r =  
  
          -1          0.999969482421875  
      DataTypeMode: Fixed-point: binary point scaling  
      Signedness: Signed  
      WordLength: 16  
      FractionLength: 15
```

Example 2: Using minlog with quantizer objects

```
1 q = quantizer;  
  warning on  
  x = [-20:10];  
  y = quantize(q,x);  
  minlog(q)  
  
Warning: 29 overflow(s) occurred in the fi quantize operation.  
> In embedded.quantizer/quantize (line 81)  
  
ans =  
  
    -1
```

The smallest value `minlog` can return is the minimum representable value of its input.

- 2 You can obtain the range of `x` after quantization using the `range` function:

```
format long g  
r = range(q)  
  
r =  
  
          -1          0.999969482421875
```

See Also

`fipref` | `maxlog` | `noverflows` | `nunderflows` | `reset` | `resetlog`

Introduced before R2006a

minus

Matrix difference between `fi` objects

Syntax

```
minus(a,b)
```

Description

`minus(a,b)` is called for the syntax `a - b` when `a` or `b` is an object.

`a - b` subtracts matrix `b` from matrix `a`. `a` and `b` must have the same dimensions unless one is a scalar value (a 1-by-1 matrix). A scalar value can be subtracted from any other value.

`minus` does not support `fi` objects of data type `Boolean`.

Note For information about the `fimath` properties involved in Fixed-Point Designer calculations, see “`fimath` Properties Usage for Fixed-Point Arithmetic” and “`fimath` ProductMode and SumMode”.

For information about calculations using Fixed-Point Designer software, see the Fixed-Point Designer documentation.

Extended Capabilities

C/C++ Code Generation

Generate C and C++ code using MATLAB® Coder™.

Usage notes and limitations:

- Any non-`fi` input must be constant; that is, its value must be known at compile time so that it can be cast to a `fi` object.

HDL Code Generation

Generate Verilog and VHDL code for FPGA and ASIC designs using HDL Coder™.

See Also

`mtimes` | `plus` | `times` | `uminus`

Introduced before R2006a

mod

Modulus after division for `fi` objects

Syntax

```
m = mod(x,y)
```

Description

`m = mod(x,y)` returns the modulus after division of `x` by `y`, where `x` is the dividend and `y` is the divisor. This function is often called the modulo operation, which can be expressed as $m = x - \text{floor}(x./y) .* y$.

For fixed-point or integer input arguments, the output data type is the aggregate type of both input signedness, word lengths, and fraction lengths. For floating-point input arguments, the output data type is the same as the inputs.

The `mod` function ignores and discards any `fimath` attached to the inputs. The output is always associated with the default `fimath`.

Note The combination of fixed-point and floating-point inputs is not supported.

Examples

Modulus of two `fi` Objects

Calculate the `mod` of two `fi` objects.

```
x = fi(-3,1,7,0);  
y = fi(2,1,15,0);  
m1 = mod(x,y)  
m2 = mod(y,x)
```

```
m1 =
```

```
1
```

```
    DataTypeMode: Fixed-point: binary point scaling  
    Signedness: Signed  
    WordLength: 15  
    FractionLength: 0
```

```
m2 =
```

```
-1
```

```
    DataTypeMode: Fixed-point: binary point scaling  
    Signedness: Signed
```

```
WordLength: 15
FractionLength: 0
```

Modulus of Two Floating-Point Inputs

Convert the `fi` inputs in the previous example to double type and calculate the mod.

```
Mf1 = mod(double(x),double(y))
Mf2 = mod(double(y),double(x))
```

```
Mf1 =
     1
```

```
Mf2 =
    -1
```

Input Arguments

x — Dividend

scalar | vector | matrix | multidimensional array

Dividend, specified as a scalar, vector, matrix, or multidimensional array. `x` must be a real-valued integer, fixed-point, or floating-point array, or real scalar. Numeric inputs `x` and `y` must either be the same size, or have sizes that are compatible.

Data Types: `single` | `double` | `int8` | `int16` | `int32` | `int64` | `uint8` | `uint16` | `uint32` | `uint64` | `fi`

y — Divisor

scalar | vector | matrix | multidimensional array

Divisor, specified as a scalar, vector, matrix, or multidimensional array. `y` must be a real-valued integer, fixed-point, or floating-point array, or real scalar. Numeric inputs `x` and `y` must either be the same size, or have sizes that are compatible.

Data Types: `single` | `double` | `int8` | `int16` | `int32` | `int64` | `uint8` | `uint16` | `uint32` | `uint64` | `fi`

Output Arguments

m — Result of modulus operation

scalar | vector | matrix | multidimensional array

Result of modulus operation, returned as a scalar, vector, matrix, or multidimensional array.

If both inputs `x` and `y` are floating-point, then the data type of `m` is the same as the inputs. If either input `x` or `y` is fixed-point, then the data type of `m` is the aggregate `numericType`. This value equals that of `fixed.aggregateType(x,y)`.

The output `m` is always associated with the default `fi` math.

Algorithms

`mod(x,y)` for a `fi` object uses the same definition as the built-in MATLAB `mod` function.

See Also

`fixed.aggregateType` | `mod`

Introduced in R2011b

modByConstant

Modulus after division by a constant denominator

Syntax

$Y = \text{modByConstant}(X, d)$

Description

$Y = \text{modByConstant}(X, d)$ performs the modulo operation (remainder after division) of X with respect to the denominator d .

For simulation, the data type of the output Y is chosen based on the value of the denominator d and the range of X .

To generate code, the denominator d must be a constant.

Examples

Modulo by Constant Denominator

```
modByConstant(fi(10203), 10)
```

```
ans =
```

```
3
```

```
    DataTypeMode: Fixed-point: binary point scaling
    Signedness:   Unsigned
    WordLength:   5
    FractionLength: 1
```

```
modByConstant(uint16(6930), 1024)
```

```
ans =
```

```
786
```

```
    DataTypeMode: Fixed-point: binary point scaling
    Signedness:   Unsigned
    WordLength:   10
    FractionLength: 0
```

Input Arguments

X — Dividend

scalar | vector | matrix | multidimensional array

Dividend, specified as a scalar, vector, matrix, or multidimensional array.

If X is a fixed-point or scaled-double `fi`, it must use binary point scaling.

Data Types: `single` | `double` | `int8` | `int16` | `int32` | `int64` | `uint8` | `uint16` | `uint32` | `uint64` | `logical` | `fi`

d — Divisor

positive scalar

Divisor, specified as a positive, real-valued scalar.

If `d` is a fixed-point or scaled-double `fi`, it must use binary point scaling.

To generate code, the denominator `d` must be a constant.

Data Types: `single` | `double` | `int8` | `int16` | `int32` | `int64` | `uint8` | `uint16` | `uint32` | `uint64` | `logical` | `fi`

Output Arguments**Y — Result of modulus operation**

scalar | vector | matrix | multidimensional array

Result of modulus operation, returned as a scalar, vector, matrix, or multidimensional array.

For simulation, the data type of the output `Y` is chosen based on the value of the denominator `d` and the range of `X`.

Extended Capabilities**C/C++ Code Generation**

Generate C and C++ code using MATLAB® Coder™.

Slope-bias representation is not supported for fixed-point data types.

Fixed-Point Conversion

Design and simulate fixed-point systems using Fixed-Point Designer™.

Slope-bias representation is not supported for fixed-point data types.

See Also

Introduced in R2021a

mpower

Fixed-point matrix power (^)

Syntax

```
c = mpower(a,k)
c = a^k
```

Description

`c = mpower(a,k)` and `c = a^k` compute matrix power. The exponent k requires a positive, real-valued integer value.

The fixed-point output array c has the same local fimath as the input a . If a has no local fimath, the output c also has no local fimath. The matrix power operation is performed using default fimath settings.

Examples

Compute the power of a 2-dimensional square matrix for exponent values 0, 1, 2, and 3.

```
x = fi([0 1; 2 4], 1, 32);
px0 = x^0
px1 = x^1
px2 = x^2
px3 = x^3
```

Tips

For more information about the `mpower` function, see the MATLAB `mpower` reference page.

Extended Capabilities

C/C++ Code Generation

Generate C and C++ code using MATLAB® Coder™.

Usage notes and limitations:

- When the exponent k is a variable and the input is a scalar, the `ProductMode` property of the governing fimath must be `SpecifyPrecision`.
- When the exponent k is a variable and the input is not scalar, the `SumMode` property of the governing fimath must be `SpecifyPrecision`.
- Variable-sized inputs are only supported when the `SumMode` property of the governing fimath is set to `SpecifyPrecision` or `Keep LSB`.
- For variable-sized signals, you may see different results between the generated code and MATLAB.

- In the generated code, the output for variable-sized signals is computed using the `SumMode` property of the governing `fimath`.
- In MATLAB, the output for variable-sized signals is computed using the `SumMode` property of the governing `fimath` when the first input, `a`, is nonscalar. However, when `a` is a scalar, MATLAB computes the output using the `ProductMode` of the governing `fimath`.

HDL Code Generation

Generate Verilog and VHDL code for FPGA and ASIC designs using HDL Coder™.

Both inputs must be scalar, and the exponent input, `k`, must be a constant integer.

See Also

`mpower` | `power`

Introduced in R2010a

mpy

Multiply two objects using `fimath` object

Syntax

```
c = mpy(F,a,b)
```

Description

`c = mpy(F,a,b)` performs elementwise multiplication on `a` and `b` using `fimath` object `F`. This is helpful in cases when you want to override the `fimath` objects of `a` and `b`, or if the `fimath` properties associated with `a` and `b` are different. The output `fi` object `c` has no local `fimath`.

`a` and `b` can both be `fi` objects with the same dimensions unless one is a scalar. If either `a` or `b` is scalar, then `c` has the dimensions of the nonscalar object. `a` and `b` can also be doubles, singles, or integers.

Examples

In this example, `c` is the 40-bit product of `a` and `b` with fraction length 30.

```
a = fi(pi);
b = fi(exp(1));
F = fimath('ProductMode','SpecifyPrecision',...
          'ProductWordLength',40,'ProductFractionLength',30);
c = mpy(F, a, b)
```

```
c =
```

```
8.5397
```

```
      DataTypeMode: Fixed-point: binary point scaling
      Signedness: Signed
      WordLength: 40
      FractionLength: 30
```

Algorithms

`c = mpy(F,a,b)` is similar to

```
a.fimath = F;
b.fimath = F;
c = a .* b
```

```
c =
```

```
8.5397
```

```
      DataTypeMode: Fixed-point: binary point scaling
      Signedness: Signed
      WordLength: 40
```

```
FractionLength: 30
    RoundingMethod: nearest
    OverflowAction: saturate
        ProductMode: SpecifyPrecision
    ProductWordLength: 40
    ProductFractionLength: 30
        SumMode: FullPrecision
```

but not identical. When you use `mpy`, the `fimath` properties of `a` and `b` are not modified, and the output `fi` object `c` has no local `fimath`. When you use the syntax `c = a .* b`, where `a` and `b` have their own `fimath` objects, the output `fi` object `c` gets assigned the same `fimath` object as inputs `a` and `b`. See “`fimath` Rules for Fixed-Point Arithmetic” in the Fixed-Point Designer User's Guide for more information.

Extended Capabilities

C/C++ Code Generation

Generate C and C++ code using MATLAB® Coder™.

Usage notes and limitations:

- Code generation does not support the syntax `F.mpy(a,b)`. You must use the syntax `mpy(F,a,b)`.
- When you provide complex inputs to the `mpy` function inside of a MATLAB Function block, you must declare the input as complex before running the simulation. To do so, go to the **Ports and data manager** and set the **Complexity** parameter for all known complex inputs to `0n`.

See Also

`add` | `divide` | `fi` | `fimath` | `mrdivide` | `numericType` | `rdivide` | `sub` | `sum`

Introduced before R2006a

mrdivide, /

Package: embedded

Right-matrix division

Syntax

```
X = A/b
X = mrdivide(A, b)
```

Description

$X = A/b$ performs right-matrix division.

$X = \text{mrdivide}(A, b)$ is an alternative way to execute $X = A/b$.

Examples

Divide fi Matrix by a Constant

In this example, you use the forward slash (/) operator to perform right matrix division on a 3-by-3 magic square of `fi` objects. Because the numerator input is a `fi` object, the denominator input `b` must be a scalar.

```
A = fi(magic(3))
```

```
A=3x3 object
```

```
  8   1   6
  3   5   7
  4   9   2
```

```
      DataTypeMode: Fixed-point: binary point scaling
      Signedness: Signed
      WordLength: 16
      FractionLength: 11
```

```
b = fi(3,1,12,8)
```

```
b =
```

```
  3
```

```
      DataTypeMode: Fixed-point: binary point scaling
      Signedness: Signed
      WordLength: 12
      FractionLength: 8
```

```
X = A/b
```

```
X=3x3 object
```

```
  2.6250   0.3750   2.0000
  1.0000   1.6250   2.3750
```

```
1.3750    3.0000    0.6250
```

```
    DataTypeMode: Fixed-point: binary point scaling  
    Signedness: Signed  
    WordLength: 16  
    FractionLength: 3
```

Perform Matrix Division

You can perform right-matrix division when neither input is a `fi` object. The matrix dimensions must be compatible for matrix division.

```
A = [2, 3, 1; 0, 8, 4; 1, 1, 0]
```

```
A = 3×3
```

```
    2    3    1  
    0    8    4  
    1    1    0
```

```
B = [7, 6, 6; 1, 0, 5; 9, 0, 4]
```

```
B = 3×3
```

```
    7    6    6  
    1    0    5  
    9    0    4
```

```
X = mrdivide(A,B)
```

```
X = 3×3
```

```
    0.5000   -0.2927   -0.1341  
    1.3333    0.0325   -1.0407  
    0.1667   -0.2033    0.0041
```

Input Arguments

A — Numerator

scalar | vector | matrix | multidimensional array

Numerator, specified as a scalar, vector, matrix, or multidimensional array. If one or both of the inputs is a `fi` object, then `b` must be a scalar. When `b` is a scalar, `mrdivide` is equivalent to `rdivide`.

Data Types: `single` | `double` | `int8` | `int16` | `int32` | `int64` | `uint8` | `uint16` | `uint32` | `uint64` | `logical` | `fi`

Complex Number Support: Yes

b — Denominator

scalar | vector | matrix | multidimensional array

Denominator, specified as a real scalar, vector, matrix, or multidimensional array. If one or both of the inputs is a `fi` object, then `b` must be a scalar. When `b` is a scalar, `mrdivide` is equivalent to `rdivide`.

If neither input is a `fi` object, then the sizes of the input matrices must be compatible for matrix division.

Data Types: `single` | `double` | `int8` | `int16` | `int32` | `int64` | `uint8` | `uint16` | `uint32` | `uint64` | `logical` | `fi`

Output Arguments

X — Quotient

`scalar` | `vector` | `matrix` | `multidimensional array`

Solution, returned as an array with the same dimensions as the numerator input `A`. When `A` is complex, the real and imaginary parts of `A` are independently divided by `b`.

Extended Capabilities

C/C++ Code Generation

Generate C and C++ code using MATLAB® Coder™.

See Also

`add` | `divide` | `fi` | `fimath` | `numericType` | `rdivide` | `sub` | `sum`

Introduced in R2009a

mtimes

Matrix product of `fi` objects

Syntax

```
mtimes(a,b)
```

Description

`mtimes(a,b)` is called for the syntax `a * b` when `a` or `b` is an object.

`a * b` is the matrix product of `a` and `b`. A scalar value (a 1-by-1 matrix) can multiply any other value. Otherwise, the number of columns of `a` must equal the number of rows of `b`.

`mtimes` does not support `fi` objects of data type `Boolean`.

Note For information about the `fimath` properties involved in Fixed-Point Designer calculations, see “`fimath` Properties Usage for Fixed-Point Arithmetic” and “`fimath` ProductMode and SumMode”.

For information about calculations using Fixed-Point Designer software, see the Fixed-Point Designer documentation.

Extended Capabilities

C/C++ Code Generation

Generate C and C++ code using MATLAB® Coder™.

Usage notes and limitations:

- Any non-`fi` input must be constant; that is, its value must be known at compile time so that it can be cast to a `fi` object.
- Variable-sized inputs are only supported when the `SumMode` property of the governing `fimath` is set to `SpecifyPrecision` or `KeepLSB`.
- For variable-sized signals, you may see different results between the generated code and MATLAB.
 - In the generated code, the output for variable-sized signals is computed using the `SumMode` property of the governing `fimath`.
 - In MATLAB, the output for variable-sized signals is computed using the `SumMode` property of the governing `fimath` when both inputs are nonscalar. However, if either input is a scalar, MATLAB computes the output using the `ProductMode` of the governing `fimath`.

HDL Code Generation

Generate Verilog and VHDL code for FPGA and ASIC designs using HDL Coder™.

See Also

`minus` | `plus` | `times` | `uminus`

Introduced before R2006a

ne

Determine whether real-world values of two `fi` objects are not equal

Syntax

```
c = ne(a,b)
a ~= b
```

Description

`c = ne(a,b)` is called for the syntax `a ~= b` when `a` or `b` is a `fi` object. `a` and `b` must have the same dimensions unless one is a scalar. A scalar can be compared with another object of any size.

`a ~= b` does an element-by-element comparison between `a` and `b` and returns a matrix of the same size with elements set to `1` where the relation is true, and `0` where the relation is false.

In relational operations comparing a floating-point value to a fixed-point value, the floating-point value is cast to the same word length and signedness as the `fi` object, with best-precision scaling.

Examples

Compare Two `fi` Objects

Use the `ne` function to determine whether the real-world values of two `fi` objects are not equal.

```
a = fi(pi);
b = fi(pi, 1, 32);
a ~= b

ans = logical
     1
```

Input `a` has a 16-bit word length, while input `b` has a 32-bit word length. The `ne` function returns `1` because after quantization, the value of `a` is greater than that of `b`.

Compare a Double to a `fi` Object

When comparing a double to a `fi` object, the double is cast to the same word length and signedness of the `fi` object.

```
a = fi(pi);
b = pi;
a ~= b

ans = logical
     0
```

The `ne` function casts `b` to the same word length as `a`, and returns `0` because the two inputs have the same real-world value. This behavior allows relational operations to work between `fi` objects and floating-point constants without introducing floating-point values in generated code.

Extended Capabilities

C/C++ Code Generation

Generate C and C++ code using MATLAB® Coder™.

Usage notes and limitations:

- Fixed-point signals with different biases are not supported.

HDL Code Generation

Generate Verilog and VHDL code for FPGA and ASIC designs using HDL Coder™.

See Also

`eq` | `ge` | `gt` | `le` | `lt`

Introduced before R2006a

nearest

Round toward nearest integer with ties rounding toward positive infinity

Syntax

```
y = nearest(a)
```

Description

`y = nearest(a)` rounds `fi` object `a` to the nearest integer or, in case of a tie, to the nearest integer in the direction of positive infinity, and returns the result in `fi` object `y`.

Examples

Use nearest on a Signed `fi` Object

The following example demonstrates how the `nearest` function affects the `numericType` properties of a signed `fi` object with a word length of 8 and a fraction length of 3.

```
a = fi(pi,1,8,3)
a =
    3.1250
        DataTypeMode: Fixed-point: binary point scaling
        Signedness: Signed
        WordLength: 8
        FractionLength: 3

y = nearest(a)
y =
    3
        DataTypeMode: Fixed-point: binary point scaling
        Signedness: Signed
        WordLength: 6
        FractionLength: 0
```

The following example demonstrates how the `nearest` function affects the `numericType` properties of a signed `fi` object with a word length of 8 and a fraction length of 12.

```
a = fi(0.025,1,8,12)
a =
    0.0249
        DataTypeMode: Fixed-point: binary point scaling
        Signedness: Signed
        WordLength: 8
        FractionLength: 12
```

```
y = nearest(a)
```

```
y =
     0
```

```

    DataTypeMode: Fixed-point: binary point scaling
    Signedness: Signed
    WordLength: 2
    FractionLength: 0
```

Compare Rounding Methods

The functions `convergent`, `nearest`, and `round` differ in the way they treat values whose least significant digit is 5.

- The `convergent` function rounds ties to the nearest even integer.
- The `nearest` function rounds ties to the nearest integer toward positive infinity.
- The `round` function rounds ties to the nearest integer with greater absolute value.

This example illustrates these differences for a given input, `a`.

```
a = fi([-3.5:3.5]');
y = [a convergent(a) nearest(a) round(a)]
```

```

y=8x4 object
-3.5000 -4.0000 -3.0000 -4.0000
-2.5000 -2.0000 -2.0000 -3.0000
-1.5000 -2.0000 -1.0000 -2.0000
-0.5000 0 0 -1.0000
0.5000 0 1.0000 1.0000
1.5000 2.0000 2.0000 2.0000
2.5000 2.0000 3.0000 3.0000
3.5000 3.9999 3.9999 3.9999
```

```

    DataTypeMode: Fixed-point: binary point scaling
    Signedness: Signed
    WordLength: 16
    FractionLength: 13
```

Input Arguments

a — Input `fi` array

scalar | vector | matrix | multidimensional array

Input `fi` array, specified as scalar, vector, matrix, or multidimensional array.

For complex `fi` objects, the imaginary and real parts are rounded independently.

`nearest` does not support `fi` objects with nontrivial slope and bias scaling. Slope and bias scaling is trivial when the slope is an integer power of 2 and the bias is 0.

Data Types: `fi`

Complex Number Support: Yes

Algorithms

- `y` and `a` have the same `fimath` object and `DataType` property.
- When the `DataType` property of `a` is `single`, `double`, or `boolean`, the `numericType` of `y` is the same as that of `a`.
- When the fraction length of `a` is zero or negative, `a` is already an integer, and the `numericType` of `y` is the same as that of `a`.
- When the fraction length of `a` is positive, the fraction length of `y` is 0, its sign is the same as that of `a`, and its word length is the difference between the word length and the fraction length of `a`, plus one bit. If `a` is signed, then the minimum word length of `y` is 2. If `a` is unsigned, then the minimum word length of `y` is 1.

Extended Capabilities

C/C++ Code Generation

Generate C and C++ code using MATLAB® Coder™.

HDL Code Generation

Generate Verilog and VHDL code for FPGA and ASIC designs using HDL Coder™.

See Also

`ceil` | `convergent` | `fix` | `floor` | `round`

Introduced in R2008a

nearestDiv

Round the result of division toward the nearest integer

Syntax

```
y = nearestDiv(x,d)
y = nearestDiv(x,d,m)
```

Description

`y = nearestDiv(x,d)` returns the result of x/d rounded to the nearest integer value.

`y = nearestDiv(x,d,m)` returns the result of x/d rounded to the nearest multiple of m .

The datatype of y is calculated such that the wordlength and fraction length are of a sufficient size to contain both the largest and smallest possible solutions given the data type of x , and the values of d and m .

Examples

Divide and Round to Nearest

Perform a division operation and round to the nearest integer value.

```
nearestDiv(int16(201),10)
```

```
ans =
```

```
20
```

```
      DataTypeMode: Fixed-point: binary point scaling
      Signedness: Signed
      WordLength: 14
      FractionLength: 0
```

Perform a division operation and round to the nearest multiple of 7.

```
nearestDiv(int16(201),10,7)
```

```
ans =
```

```
21
```

```
      DataTypeMode: Fixed-point: binary point scaling
      Signedness: Signed
```

WordLength: 14
FractionLength: 0

Input Arguments

x — Dividend

scalar

Dividend, specified as a scalar.

Data Types: `single` | `double` | `int8` | `int16` | `int32` | `int64` | `uint8` | `uint16` | `uint32` | `uint64` | `logical` | `fi`

d — Divisor

scalar

Divisor, specified as a scalar.

Data Types: `single` | `double` | `int8` | `int16` | `int32` | `int64` | `uint8` | `uint16` | `uint32` | `uint64` | `logical` | `fi`

m — Value to round to nearest multiple of

1 (default) | scalar

Value to round to nearest multiple of, specified as a scalar.

Data Types: `single` | `double` | `int8` | `int16` | `int32` | `int64` | `uint8` | `uint16` | `uint32` | `uint64` | `logical` | `fi`

Output Arguments

y — Result of division and round to floor

scalar

Result of division and round to floor, returned as a scalar.

The datatype of `y` is calculated such that the wordlength and fraction length are of a sufficient size to contain both the largest and smallest possible solutions given the data type of `x`, and the values of `d` and `m`.

Extended Capabilities

C/C++ Code Generation

Generate C and C++ code using MATLAB® Coder™.

Slope-bias representation is not supported for fixed-point data types.

Fixed-Point Conversion

Design and simulate fixed-point systems using Fixed-Point Designer™.

Slope-bias representation is not supported for fixed-point data types.

See Also

`ceilDiv` | `fixDiv` | `floorDiv`

Introduced in R2021a

nextpow2

Package: embedded

Exponent of next higher power of 2 of `fi` object

Syntax

`P = nextpow2(N)`

Description

`P = nextpow2(N)` returns the first `P` such that $2.^P \geq \text{abs}(N)$. By convention, `nextpow2(0)` returns zero.

Examples

Next Power of 2 of `fi` Object

Define a `fi` object and calculate the exponent for the next higher power of 2.

```
N = fi(1000,1,18,2);  
P = nextpow2(N)
```

```
P =
```

```
10
```

```
    DataTypeMode: Fixed-point: binary point scaling  
    Signedness: Signed  
    WordLength: 6  
    FractionLength: 0
```

Next Power of 2 of `fi` Values

Define a vector of `fi` values and calculate the exponents for the next power of 2 higher than those values.

```
N = fi([1 -2 3 -4 5 9 519],1,16,3,2);  
P = nextpow2(N)
```

```
P =
```

```
1     0     1     2     3     3    10
```

```
    DataTypeMode: Fixed-point: binary point scaling  
    Signedness: Unsigned
```

```
WordLength: 5  
FractionLength: 0
```

Input Arguments

N — Input values

scalar | vector | *N*-dimensional array

Input values, specified as a real-valued scalar, vector, or *N*-dimensional array.

Data Types: `fi`

Output Arguments

P — Exponent of next higher power of 2

scalar | vector | *N*-dimensional array

Exponent of next higher power of 2, returned as a scalar, vector, or *N*-dimensional array.

The output is returned as an unsigned `fi` object with binary-point scaling, a fraction length of zero, and the smallest word length which can represent the value of the largest returned exponent.

Extended Capabilities

C/C++ Code Generation

Generate C and C++ code using MATLAB® Coder™.

Slope-bias representation is not supported for code generation.

Fixed-Point Conversion

Design and simulate fixed-point systems using Fixed-Point Designer™.

See Also

`fi` | `nextpow2`

Introduced in R2020a

nnz

Package: embedded

Number of nonzero elements in `fi` object

Syntax

```
N = nnz(X)
```

Description

`N = nnz(X)` returns the number of nonzero elements in `X`.

When `X` is a built-in MATLAB type, floating-point `fi` object, or scaled double `fi` object, `N` is returned as a `double`. When `X` is a fixed-point `fi` object, `N` is returned as a `uint32` if `X` has fewer than 2^{32} elements. Otherwise, `N` is returned as a `uint64`.

Examples

Number of Nonzero Elements in `fi` Object

Create a `fi` object and determine the number of nonzero elements it contains.

```
p = fi([],1,24,12);  
X = eye(2,3,'like',p)
```

```
X =
```

```
    1    0    0  
    0    1    0
```

```
      DataTypeMode: Fixed-point: binary point scaling  
      Signedness: Signed  
      WordLength: 24  
      FractionLength: 12
```

```
N = nnz(X)
```

```
N =
```

```
uint32
```

```
    2
```

Input Arguments

X — Input array

scalar | vector | matrix | multidimensional array

Input array, specified as a scalar, vector, matrix, or multidimensional array.

Data Types: `single` | `double` | `int8` | `int16` | `int32` | `int64` | `uint8` | `uint16` | `uint32` | `uint64` | `logical` | `fi`
Complex Number Support: Yes

Extended Capabilities

C/C++ Code Generation

Generate C and C++ code using MATLAB® Coder™.

See Also

`fi` | `nnz`

Introduced in R2020b

noperations

Number of operations

Syntax

```
noperations(q)
```

Description

`noperations(q)` is the number of quantization operations during a call to `quantize(q, ...)` for quantizer object `q`. This value accumulates over successive calls to `quantize`. You reset the value of `noperations` to zero by issuing the command `resetlog(q)`.

Each time any data element is quantized, `noperations` is incremented by one. The real and complex parts are counted separately. For example, `(complex * complex)` counts four quantization operations for products and two for sum, because $(a+bi)*(c+di) = (a*c - b*d) + (a*d + b*c)$. In contrast, `(real*real)` counts one quantization operation.

In addition, the real and complex parts of the inputs are quantized individually. As a result, for a complex input of length 204 elements, `noperations` counts 408 quantizations: 204 for the real part of the input and 204 for the complex part.

If any inputs, states, or coefficients are complex-valued, they are all expanded from real values to complex values, with a corresponding increase in the number of quantization operations recorded by `noperations`. In concrete terms, `(real*real)` requires fewer quantizations than `(real*complex)` and `(complex*complex)`. Changing all the values to complex because one is complex, such as the coefficient, makes the `(real*real)` into `(real*complex)`, raising `noperations` count.

See Also

`maxlog` | `minlog`

Introduced before R2006a

normalizedReciprocal

Compute normalized reciprocal

Syntax

```
[y,e] = normalizedReciprocal(u)
```

Description

`[y,e] = normalizedReciprocal(u)` returns `y` and `e` such that $(2.^e) .* y = 1./u$ and $0.5 < \text{abs}(y) \leq 1$.

- If `u = 0` and `u` is a fixed-point or scaled-double data type, then $y = 2^{-\text{eps}(y)}$ and $e = 2^{(\text{nextpow2}(w) - w + f)}$, where w is the word length of `u` and f is the fraction length of `u`.
- If `u = 0` and `u` is a floating-point data type, then $y = \text{Inf}$ and $t = 1$.

Examples

Compute Normalized Reciprocal of a Fixed-Point Vector

This example shows how to compute the element-wise normalized reciprocal of a vector of fixed-point values.

```
u = fi([-pi,0.01,pi])
```

```
u=1x3 object
   -3.1416    0.0100    3.1416
```

```
      DataTypeMode: Fixed-point: binary point scaling
      Signedness: Signed
      WordLength: 16
      FractionLength: 13
```

```
[y,e] = normalizedReciprocal(u)
```

```
y=1x3 object
   -0.6367    0.7806    0.6367
```

```
      DataTypeMode: Fixed-point: binary point scaling
      Signedness: Signed
      WordLength: 16
      FractionLength: 14
```

```
e = 1x3 int32 row vector
```

```
   -1     7    -1
```

Input Arguments

u — Input to take normalized reciprocal of

scalar | vector | matrix | N -dimensional array

Input to take the normalized reciprocal of, specified as a real-valued scalar, vector, matrix, or N -dimensional array.

Data Types: `single` | `double` | `fi`

Output Arguments

y — Normalized reciprocal

scalar | vector | matrix | N -dimensional array

Normalized reciprocal that satisfies $0.5 < \text{abs}(y) \leq 1$ and $(2.^e) .* y = 1./u$, returned as a scalar, vector, matrix, or N -dimensional array.

- If the input u is a signed fixed-point or scaled-double data type with word length w , then y is a signed fixed-point or scaled-double with word length w and fraction length $w - 2$.
- If the input u is an unsigned fixed-point or scaled-double data type with word length w , then y is an unsigned fixed-point or scaled-double with word length w and fraction length $w - 1$.
- If the input u is a double, then y is a double.
- If the input u is a single, the y is a single.

e — Exponent

scalar | vector | matrix | N -dimensional array

Exponent that satisfies $0.5 < \text{abs}(y) \leq 1$ and $(2.^e) .* y = 1./u$, returned as an integer scalar, vector, matrix, or N -dimensional array.

Extended Capabilities

C/C++ Code Generation

Generate C and C++ code using MATLAB® Coder™.

Fixed-Point Conversion

Design and simulate fixed-point systems using Fixed-Point Designer™.

Slope-bias representation is not supported for fixed-point data types.

See Also

Functions

`fi`

Blocks

Normalized Reciprocal HDL Optimized

Topics

“How to Use HDL Optimized Normalized Reciprocal”

Introduced in R2020a

noverflows

Number of overflows

Syntax

```
y = noverflows(a)  
y = noverflows(q)
```

Description

`y = noverflows(a)` returns the number of overflows of `fi` object `a` since logging was turned on or since the last time the log was reset for the object.

Turn on logging by setting the `fipref` property `LoggingMode` to `on`. Reset logging for a `fi` object using the `resetlog` function.

`y = noverflows(q)` returns the accumulated number of overflows resulting from quantization operations performed by a quantizer object `q`.

See Also

`maxlog` | `minlog` | `nunderflows` | `resetlog`

Introduced before R2006a

nts

Determine fixed-point data type

Syntax

```
nts
nts({'block',PORT})
nts({line-handle})
nts({gsl})
```

Description

`nts` opens the `NumericTypeScope` window. To connect to a signal in a Simulink model, select the signal and then, in the `NumericTypeScope` window, select **File > Connect to Simulink Signal**.

The `NumericTypeScope` suggests a fixed-point data type in the form of a `numericType` object based on the dynamic range of the input data and the criteria that you specify in the “Bit Allocation Panel” on page 4-593. The scope allows you to visualize the dynamic range of data in the form of a \log_2 histogram. It displays the data values on the X-axis and the number or percentage of occurrences on the Y-axis. Each bin in the histogram corresponds to a bit in a word. For example, 2^0 corresponds to the first integer bit in the binary word, 2^{-1} corresponds to the first fractional bit in the binary word.

`nts({'block',PORT})` opens the `NumericTypeScope` window and connects the scope to the signal output from `block` on output port with index `PORT`. If the block has more than one output port, you must specify the port index. The scope cannot connect to more than one output port.

`nts({line-handle})` opens the `NumericTypeScope` window and connects the scope to the Simulink signal which has the line handle specified in `line-handle`.

`nts({gsl})` opens the `NumericTypeScope` window and connects the scope to the currently selected Simulink signal. You must select a signal in a Simulink model first, otherwise the scope opens with no signal selected.

Input Arguments

block

Full path to the specified block.

line-handle

Handle of the Simulink signal that you want to view with the scope. To get the handle of the currently selected signal, at the MATLAB command line, enter `gsl`.

PORT

Index of the output port that you want to view with the scope. If the block has more than one output port, you must specify the index. The scope cannot connect to more than one output port.

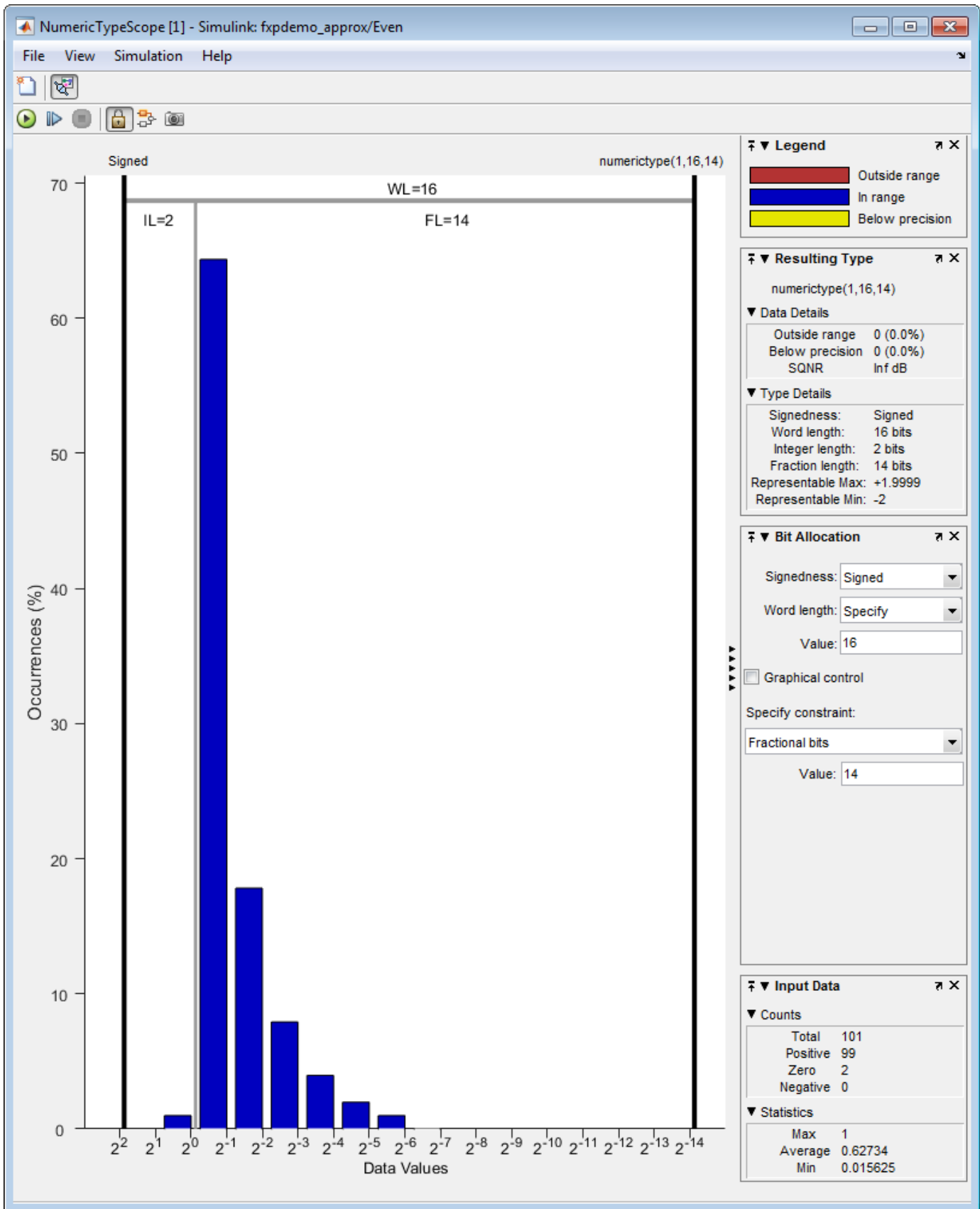

The NumericTypeScope Window

The `NumericTypeScope` opens with the default toolbars on page 4-590 displayed at the top of the window and the dialog panels on page 4-593 to the right.









Toolbars

By default the scope displays a toolbar that provides these options:

Button	Action
	New NumericTypeScope.
	Connect to Simulink signal. The scope connects to the currently selected signal. If a block with only one output port is selected and the Connect scope on selection of is set to Signal lines or blocks , connects to the output port of the selected block. For more information, see “Sources Pane” on page 4-592.

After connecting the scope to a signal in a Simulink model, the scope displays an additional toolbar with the following options:

Button	Action
	Stop simulation
	Start simulation
	Simulate one step
	Snapshot. Freezes the display so that you can examine the results. To reenable display refreshing, click the button again.
	Highlight Simulink signal.
	Persistent. By default, the scope makes a persistent connection to the selected signal. If you want to view different signals during the simulation, click this button to make a floating connection. You can then select any signal in the model and the scope displays it.

Dialog Boxes and Panels

- “Configuration Dialog Box” on page 4-590
- “Dialog Panels” on page 4-593

Configuration Dialog Box

Use the NumericTypeScope configuration dialog box to control the behavior and appearance of the scope window.

To open the **Configuration** dialog box, from the scope main menu, select **File > Configuration > Edit**, or, with the scope as your active window, press the **N** key.

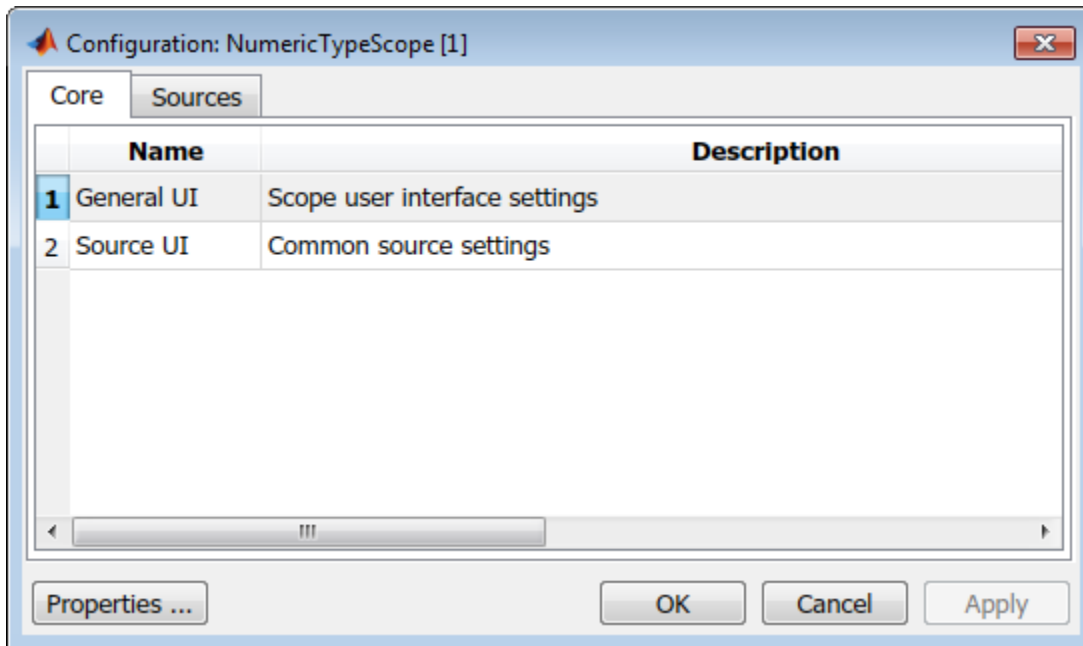

For information about each pane, see “Core Pane” on page 4-591 and “Sources Pane” on page 4-592.

To save configuration settings for future use, select **File > Configuration > Save as**. The configuration settings you save become the default configuration settings for the `NumericTypeScope`.

Caution Before saving your own set of configuration settings in the `matlab/toolbox/fixpoint` folder, save a backup copy of the default configuration settings in another location. If you do not save a backup copy of the default configuration settings, you cannot restore these settings at a later time.

To save your configuration settings for future use, save them in the `matlab/toolbox/fixpoint` folder with the file name `NumericTypeScopeSL.cfg`. You can re-save your configuration settings at anytime, but you must save them in this folder with this filename.

Core Pane

The **Core** pane controls the general settings of the scope.

To open the **Core - General UI Properties** dialog box, select **General UI** and then click **Properties**.

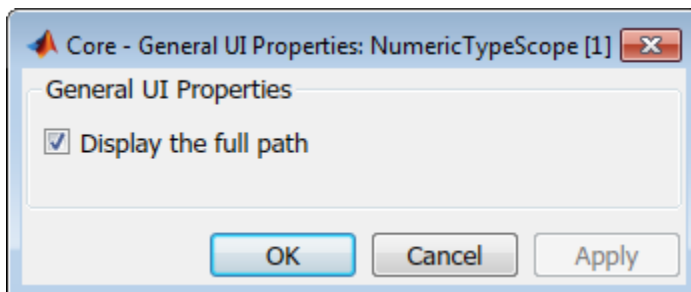

- **Display the full source path in the title bar**—Select this check box to display the full path to the selected block in the model. Otherwise, the scope displays only the block name.

To open the **Core - Source UI Properties** dialog box, select **Source UI** and then click **Properties**.

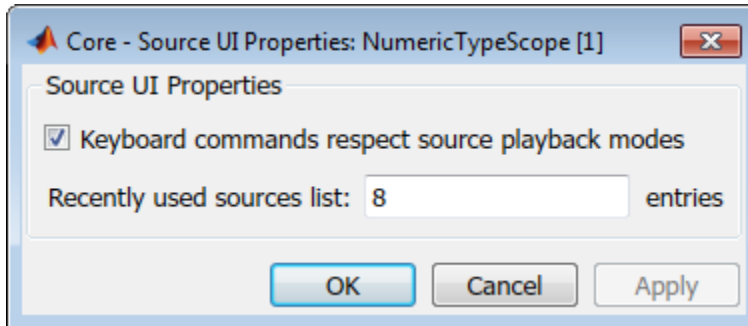

- **Keyboard commands respect source playback modes**—Has no effect. The following table shows the keyboard shortcut mapping. You cannot disable this mapping.

Action	Keyboard Shortcut
Open new NumericTypeScope	Insert
Change configuration	N
Display keyboard help	K
Play simulation	P
Pause simulation	Space
Stop simulation	S
Step forward	Right arrow, Page down

- **Recently used sources list**—Sets the maximum number of recently used sources displayed under the **Files** menu option.

Sources Pane

The **Sources** pane controls how the scope connects to Simulink. You cannot disable the Simulink source.

To open the **Sources - Simulink Properties** dialog box, select the **Sources** tab and then click **Properties**.

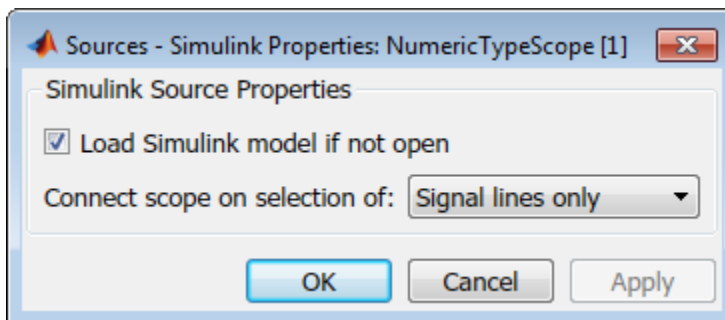

- **Load Simulink model if not open**—When selected, if you specify a signal in a Simulink model that is not currently open, the scope opens the model.

- **Connect scope on selection of**—Connects the scope only when you select signal lines or when you select signal lines or blocks. If you select `Signal lines or blocks`, the scope cannot connect to blocks that have more than one output port.

Dialog Panels

Bit Allocation Panel

The scope **Bit Allocation** panel provides options for specifying data type criteria. Adjust these criteria to observe the effect on suggested numerictype. For streaming data, the suggested numerictype adjusts over time in order to continue to satisfy the specified criteria.

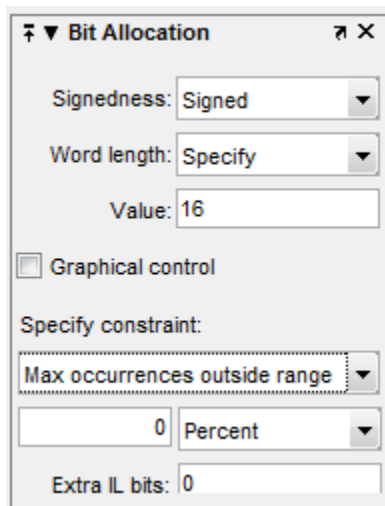

You can:

- Specify a known word length and signedness and, using **Specify constraint**, add additional constraints such as the maximum number of occurrences outside range or the smallest value that the suggested data type must represent.
- Specify **Integer length** and **Fraction length** constraints so that the scope suggests an appropriate word length.
- Set the **Signedness** and **Word length** to Auto so that the scope suggests values for these parameters.
- Enable **Graphical control** and use the cursors on either side of the binary point to adjust the fraction length and observe the effect on the suggested numerictype on the input data. For example, you can see the number of values that are outside range, below precision, or both. You can also view representable minimum and maximum values of the changed suggested data type.
- Specify extra bits for either the fraction length or the integer length. The extra bits act as a safety margin to minimize the risk of overflow and precision loss.

Legend

The scope **Legend** panel informs you which colors the scope uses to indicate values. These colors represent values that are outside range, in range, or below precision when displayed in the scope.

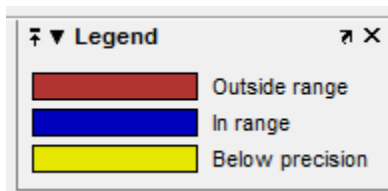

Resulting Type

The **Resulting Type** panel describes the fixed-point data type as defined by scope settings. By manipulating the visual display (via the **Bit Allocation** panel or with the cursors), you can change the data type specification.

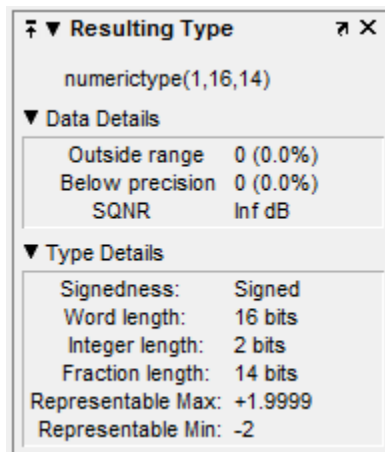

The **Data Details** section displays the percentage of values that fall outside range or below precision with the `numeric type` object located at the top of this panel. SQNR (Signal Quantization Noise Ratio) varies depending on the signal. If the parameter has no value, then there is not enough data to calculate the SQNR. When scope information or the `numeric type` changes, the SQNR resets.

The **Type Details** section provides details about the fixed-point data type. You can copy the `numeric type` specification by right-clicking the **Resulting Type** pane and then selecting Copy `numeric type`.

Input Data

The **Input Data** panel provides statistical information about the values currently displayed in the `NumericScopeType`.

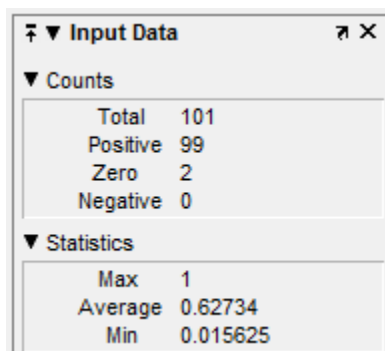

Examples

Connect a NumericTypeScope to a signal in a Simulink model

Open a NumericTypeScope window and connect to a signal.

Open the model.

fxpdemo_approx

Open a NumericTypeScope.

nts

In the fxpdemo_approx model, select the yEven signal.

In the NumericTypeScope window, select **File > Connect to Simulink Signal**.

Run the simulation to view the dynamic range of the output. The NumericTypeScope suggests a data type for the output.

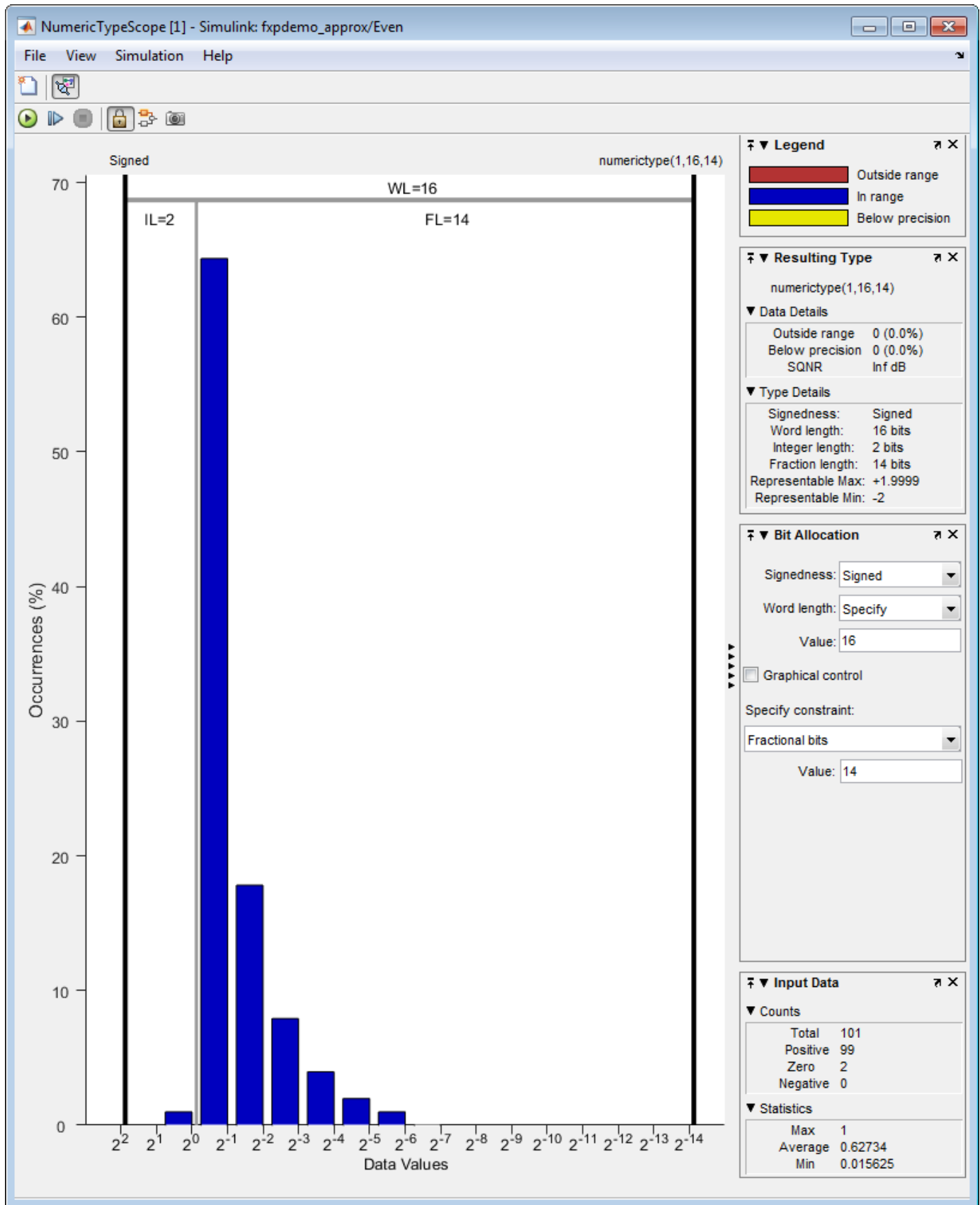

Connect a NumericTypeScope to a block output port

Connect a NumericTypeScope to a block output port and view the dynamic range of block output.

Specify the block path and name and the output port number.

```
blk='fxpdemo_approx/Even';  
nts({blk,1})
```

Run the simulation to view the dynamic range of the output. The NumericTypeScope suggests a data type for the output.

Specify a Simulink signal to display

Connect a NumericTypeScope to a signal selected in a model.

Open the model.

```
fxpdemo_approx
```

In the fxpdemo_approx model, select the yEven signal.

Open a NumericTypeScope, specifying the line handle of the selected signal.

```
nts({gsl})
```

Tips

- Use the NumericTypeScope to help you identify any values that are outside range or below precision based on the current data type.

When the information is available, the scope indicates values that are outside range, below precision, and in range of the data type by color-coding the histogram bars as follows:

- Blue — Histogram bin contains values that are in range of the current data type.
- Red — Histogram bin contains values that are outside range in the current data type.
- Yellow — Histogram bin contains values that are below precision in the current data type.
- Select **View > Vertical Units** to select whether to display values as a percentage or as an actual count.
- Use the **View > Bring All NumericTypeScope Windows Forward** menu option to manage your NumericTypeScope windows. Selecting this option or pressing **Ctrl+F** brings all NumericTypeScope windows into view.

See Also

NumericTypeScope | hist | log2

Introduced in R2012a

num2bin

Convert number to binary representation using quantizer object

Syntax

```
y = num2bin(q,x)
```

Description

`y = num2bin(q,x)` converts the numeric array `x` into a binary character vector returned in `y` using the data type properties specified by the quantizer object `q`.

If `x` is a cell array containing numeric matrices, then `x` will be a cell array of the same dimension containing binary strings. If `x` is a structure, then each numeric field of `x` is converted to binary.

`[y1,y2,...] = num2bin(q,x1,x2,...)` converts the numeric matrices `x1`, `x2`, ... to binary strings `y1`, `y2`,

Examples

Convert Numeric Matrix to Binary Character Vector

Convert a matrix of numeric values to a binary character vector using the attributes specified by a quantizer object.

```
x = magic(3)/9
```

```
x = 3×3
```

```
    0.8889    0.1111    0.6667  
    0.3333    0.5556    0.7778  
    0.4444    1.0000    0.2222
```

```
q = quantizer([5,3])
```

```
q =
```

```
    DataMode = fixed  
    RoundMode = floor  
    OverflowMode = saturate  
    Format = [5 3]
```

```
y = num2bin(q,x)
```

```
y = 9x5 char array  
    '00111'  
    '00010'  
    '00011'  
    '00000'
```



```
'00100'
'01000'
'00101'
'00110'
'00001'
```

Convert Between Binary String and Numeric Array

Convert between a binary character vector and a numeric array using the properties specified in a quantizer object.

Convert Numeric Array to Binary String

Create a `quantizer` object specifying a word length of 4 bits and a fraction length of 3 bits. The other properties of the `quantizer` object take the default values of specifying a signed, fixed-point data type, rounding towards negative infinity, and saturate on overflow.

```
q = quantizer([4 3])
```

```
q =
```

```
    DataMode = fixed
    RoundMode = floor
    OverflowMode = saturate
    Format = [4 3]
```

Create an array of numeric values.

```
[a,b] = range(q);
```

```
x = (b:-eps(q):a)
```

```
x = 1×16
```

```
    0.8750    0.7500    0.6250    0.5000    0.3750    0.2500    0.1250         0   -0.1250   -0.2500
```

Convert the numeric vector `x` to binary representation using the properties specified by the `quantizer` object `q`. Note that `num2bin` always returns the binary representations in a column.

```
b = num2bin(q,x)
```

```
b = 16×4 char array
```

```
'0111'
'0110'
'0101'
'0100'
'0011'
'0010'
'0001'
'0000'
'1111'
'1110'
'1101'
'1100'
```

```
'1011'
'1010'
'1001'
'1000'
```

Use `bin2num` to perform the inverse operation.

```
y = bin2num(q,b)
```

```
y = 16×1
```

```
0.8750
0.7500
0.6250
0.5000
0.3750
0.2500
0.1250
0
-0.1250
-0.2500
⋮
```

Convert Binary String to Numeric Array

All of the 3-bit fixed-point two's-complement numbers in fractional form are given by:

```
q = quantizer([3 2]);
b = ['011 111'
     '010 110'
     '001 101'
     '000 100'];
```

Use `bin2num` to view the numeric equivalents of these values.

```
x = bin2num(q,b)
```

```
x = 4×2
```

```
0.7500 -0.2500
0.5000 -0.5000
0.2500 -0.7500
0 -1.0000
```

Input Arguments

q — Data type properties to use for conversion

quantizer object

Data type properties to use for conversion, specified as a quantizer object.

Example: `q = quantizer([16 15]);`

x — Numeric input array

scalar | vector | matrix | multidimensional array | cell array | structure

Numeric input array, specified as a scalar, vector, matrix, multidimensional array, cell array, or structure.

Data Types: `single` | `double` | `int8` | `int16` | `int32` | `int64` | `uint8` | `uint16` | `uint32` | `uint64` | `struct` | `cell`

Tips

- `num2bin` and `bin2num` are inverses of one another. Note that `num2bin` always returns the binary representations in a column.

Algorithms

- The fixed-point binary representation is two's complement.
- The floating-point binary representation is in IEEE Standard 754 style.

See Also

`bin2num` | `hex2num` | `num2hex` | `num2int` | `quantizer`

Introduced before R2006a

num2hex

Convert number to hexadecimal equivalent using `quantizer` object

Syntax

```
y = num2hex(q,x)
```

Description

`y = num2hex(q,x)` converts numeric matrix `x` into a hexadecimal string returned in `y`. The attributes of the number are specified by the `quantizer` object `q`.

`[y1,y2,...] = num2hex(q,x1,x2,...)` converts numeric matrices `x1`, `x2`, ... to hexadecimal strings `y1`, `y2`,

Examples

Convert Numeric Matrix to Hexadecimal

Use `num2hex` to convert a matrix of numeric values to hexadecimal representation.

Convert Floating-Point Values

This is a floating-point example using a `quantizer` object `q` that has a 6-bit word length and a 3-bit exponent length.

```
x = magic(3);  
q = quantizer('float',[6 3]);  
y = num2hex(q,x)
```

```
y = 9x2 char array  
    '18'  
    '12'  
    '14'  
    '0c'  
    '15'  
    '18'  
    '16'  
    '17'  
    '10'
```

Convert Fixed-Point Values

All of the 4-bit fixed-point two's complement numbers in fractional form are given by:

```
q = quantizer([4 3]);  
x = [0.875  0.375 -0.125 -0.625  
     0.750  0.250 -0.250 -0.750  
     0.625  0.125 -0.375 -0.875  
     0.500   0    -0.500 -1.000];  
y = num2hex(q,x)
```

```

y = 16x1 char array
    '7'
    '6'
    '5'
    '4'
    '3'
    '2'
    '1'
    '0'
    'f'
    'e'
    'd'
    'c'
    'b'
    'a'
    '9'
    '8'

```

Input Arguments

q — Attributes of the number

quantizer object

Attributes of the number, specified as a quantizer object.

x — Numeric values to convert

scalar | vector | matrix | multidimensional array | cell array

Numeric values to convert, specified as a scalar, vector, matrix, multidimensional array, or cell array of doubles.

Data Types: double | cell

Complex Number Support: Yes

Output Arguments

y — Hexadecimal strings

column vector | cell array

Hexadecimal strings, returned as a column vector. If x is a cell array containing numeric matrices, then y is returned as a cell array of the same dimension containing hexadecimal strings.

Tips

- num2hex and hex2num are inverses of each other, except that hex2num returns the hexadecimal values in a column.

Algorithms

- For fixed-point quantizer objects, the representation is two's complement.
- For floating-point quantizer objects, the representation is IEEE Standard 754 style.

For example, for q = quantizer('double'):

```
q = quantizer('double');  
num2hex(q, nan)
```

```
ans =  
  
'fff8000000000000'
```

The leading fraction bit is 1, and all the other fraction bits are 0. Sign bit is 1, and exponent bits are all 1.

```
num2hex(q, inf)  
  
ans =  
  
'7ff0000000000000'
```

Sign bit is 0, exponent bits are all 1, and all fraction bits are 0.

```
num2hex(q, -inf)  
  
ans =  
  
'fff0000000000000'
```

Sign bit is 1, exponent bits are all 1, and all fraction bits are 0.

See Also

[bin2num](#) | [hex2num](#) | [num2bin](#) | [num2int](#) | [quantizer](#)

Introduced before R2006a

num2int

Convert number to signed integer using quantizer object

Syntax

```
y = num2int(q,x)
```

Description

`y = num2int(q,x)` converts numeric values in `x` to output `y` containing integers using the data type properties specified by the fixed-point quantizer object `q`. If `x` is a cell array containing numeric matrices, then `y` will be a cell array of the same dimension.

`[y1,y2,...] = num2int(q,x1,x2,...)` uses `q` to convert numeric values `x1, x2,...` to integers `y1, y2,....`

Examples

Convert Matrix of Numeric Values to Signed Integer

All the two's complement 4-bit numbers in fractional form are given by:

```
x = [0.875 0.375 -0.125 -0.625
      0.750 0.250 -0.250 -0.750
      0.625 0.125 -0.375 -0.875
      0.500 0.000 -0.500 -1.000];
```

Define a quantizer object to use for conversion.

```
q = quantizer([4 3]);
```

Use `num2int` to convert to signed integer.

```
y = num2int(q,x)
```

```
y =
```

```
    7     3     -1     -5
    6     2     -2     -6
    5     1     -3     -7
    4     0     -4     -8
```

Input Arguments

q — Data type format to use for conversion

fixed-point quantizer object

Data type format to use for conversion, specified as a fixed-point quantizer object.

Example: `q = quantizer([5 4]);`

x — Numeric values to convert

scalar | vector | matrix | multidimensional array | cell array

Numeric values to convert, specified as a scalar, vector, matrix, multidimensional array, or cell array.

Data Types: single | double | int8 | int16 | int32 | int64 | uint8 | uint16 | uint32 | uint64 | cell

Complex Number Support: Yes

Algorithms

- When *q* is a fixed-point quantizer object, *f* is equal to `fractionlength(q)`, and *x* is numeric:

$$y = x \times 2^f$$

- `num2int` is meaningful only for fixed-point quantizer objects. When *q* is a floating-point quantizer object, *x* is returned unchanged ($y = x$).
- *y* is returned as a double, but the numeric values will be integers, also known as floating-point integers or flints.

See Also`bin2num` | `hex2num` | `num2bin` | `num2hex` | `quantizer`**Introduced before R2006a**

num2str

Convert numbers to character array

Syntax

```
s = num2str(A)
s = num2str(A,precision)
s = num2str(A,formatSpec)
```

Description

`s = num2str(A)` converts `fi` object `A` into a character array representation. The output is suitable for input to the `eval` function such that `eval(s)` produces the original `fi` object exactly.

`s = num2str(A,precision)` converts `fi` object `A` to a character array representation using the number of digits of precision specified by `precision`.

`s = num2str(A,formatSpec)` applies a format specified by `formatSpec` to all elements of `A`.

Examples

Convert a `fi` Object to a Character Vector

Create a `fi` object, `A`, and convert it to a character vector.

```
A = fi(pi)
A =
    3.1416
      DataTypeMode: Fixed-point: binary point scaling
      Signedness: Signed
      WordLength: 16
      FractionLength: 13
S = num2str(A)
S =
    '3.1416'
```

Convert a `fi` Object to a Character with Specified Precision

Create a `fi` object and convert it to a character vector with 8 digits of precision.

```
A = fi(pi)
A =
```

```
3.1416
```

```
    DataTypeMode: Fixed-point: binary point scaling  
    Signedness: Signed  
    WordLength: 16  
    FractionLength: 13
```

```
S = num2str(A,8)
```

```
S =
```

```
'3.1416016'
```

Input Arguments

A — Input array

numeric array

Input array, specified as a numeric array.

Data Types: `fi` | `double` | `single` | `int8` | `int16` | `int32` | `int64` | `uint8` | `uint16` | `uint32` | `uint64` | `logical`

Complex Number Support: Yes

precision — Number of digits of precision

positive integer

Maximum number of significant digits in the output string, specified as a positive integer.

Data Types: `single` | `double` | `int8` | `int16` | `int32` | `int64` | `uint8` | `uint16` | `uint32` | `uint64`

formatSpec — Format of output fields

formatting operators

Format of the output fields, specified using formatting operators. `formatSpec` also can include ordinary text and special characters.

For more information on formatting operators, see the `num2str` reference page in the MATLAB documentation.

Output Arguments

s — Text representation of input array

character array

Text representation of the input array, returned as a character array.

See Also

`mat2str` | `num2str` | `tostring`

Introduced in R2016a

numel

Number of data elements in `fi` array

Syntax

```
n = numel(A)
```

Description

`n = numel(A)` returns the number of elements, `n`, in `fi` array `A`.

Using `numel` in your MATLAB code returns the same result for built-in types and `fi` objects. Use `numel` to write data-type independent MATLAB code for array handling.

Examples

Number of Elements in 2-D `fi` Array

Create a 2-by-3- array of `fi` objects.

```
X = fi(ones(2,3),1,24,12)
```

```
X=2x3 object
```

```
  1   1   1
  1   1   1
```

```
      DataTypeMode: Fixed-point: binary point scaling
      Signedness: Signed
      WordLength: 24
      FractionLength: 12
```

`numel` counts 6 elements in the matrix.

```
n = numel(X)
```

```
n = 6
```

Number of Elements in Multidimensional `fi` Array

Create a 2-by-3-by-4 array of `fi` objects.

```
X = fi(ones(2,3,4),1,24,12)
```

```
X =
```

```
(:,:,1) =
  1   1   1
  1   1   1
(:,:,2) =
```

```
    1    1    1
    1    1    1
(:, :, 3) =
    1    1    1
    1    1    1
(:, :, 4) =
    1    1    1
    1    1    1
```

```
    DataTypeMode: Fixed-point: binary point scaling
    Signedness: Signed
    WordLength: 24
    FractionLength: 12
```

`numel` counts 24 elements in the matrix.

```
n = numel(X)
```

```
n = 24
```

Input Arguments

A — Input array

scalar | vector | matrix | multidimensional array

Input array, specified as a scalar, vector, matrix, or multidimensional array of `fi` objects.

Complex Number Support: Yes

Extended Capabilities

C/C++ Code Generation

Generate C and C++ code using MATLAB® Coder™.

See Also

`numel`

Introduced in R2013b

numerictype

Construct an embedded `numerictype` object describing fixed-point or floating-point data type

Syntax

```
T = numerictype
T = numerictype(s)
T = numerictype(s,w)
T = numerictype(s,w,f)
T = numerictype(s,w,slope,bias)
T = numerictype(s,w,slopeadjustmentfactor,fixedexponent,bias)
T = numerictype( ____,Name,Value)
T = numerictype(T1,Name,Value)
T = numerictype('Double')
T = numerictype('Single')
T = numerictype('Half')
T = numerictype('Boolean')
```

Description

`T = numerictype` creates a default `numerictype` object.

`T = numerictype(s)` creates a fixed-point `numerictype` object with unspecified scaling, a signed property value of `s`, and a 16-bit word length.

`T = numerictype(s,w)` creates a fixed-point `numerictype` object with unspecified scaling, a signed property value of `s`, and word length of `w`.

`T = numerictype(s,w,f)` creates a fixed-point `numerictype` object with binary point scaling, a signed property value of `s`, word length of `w`, and fraction length of `f`.

`T = numerictype(s,w,slope,bias)` creates a fixed-point `numerictype` object with slope and bias scaling, a signed property value of `s`, word length of `w`, `slope`, and `bias`.

`T = numerictype(s,w,slopeadjustmentfactor,fixedexponent,bias)` creates a fixed-point `numerictype` object with slope and bias scaling, a signed property value of `s`, word length of `w`, `slopeadjustmentfactor`, and `bias`.

`T = numerictype(____,Name,Value)` allows you to set properties using name-value pairs. All properties that you do not specify a value for are assigned their default values.

`T = numerictype(T1,Name,Value)` allows you to make a copy, `T1`, of an existing `numerictype` object, `T`, while modifying any or all of the property values.

`T = numerictype('Double')` creates a `numerictype` object of data type double.

`T = numerictype('Single')` creates a `numerictype` object of data type single.

`T = numerictype('Half')` creates a `numerictype` object of data type half.

`T = numerictype('Boolean')` creates a `numerictype` object of data type Boolean.

Examples

Create a Default `numerictype` Object

This example shows how to create a `numerictype` object with default property settings.

```
T = numerictype
```

```
T =
```

```
    DataTypeMode: Fixed-point: binary point scaling
    Signedness: Signed
    WordLength: 16
    FractionLength: 15
```

Create a `numerictype` Object with Default Word Length and Scaling

This example shows how to create a `numerictype` object with the default word length and scaling by omitting the arguments for word length, `w`, and fraction length, `f`.

```
T = numerictype(1)
```

```
T =
```

```
    DataTypeMode: Fixed-point: unspecified scaling
    Signedness: Signed
    WordLength: 16
```

The object is signed, with a word length of 16 bits and unspecified scaling.

You can use the `signedness` argument, `s`, to create an unsigned `numerictype` object.

```
T = numerictype(0)
```

```
T =
```

```
    DataTypeMode: Fixed-point: unspecified scaling
    Signedness: Unsigned
    WordLength: 16
```

The object is has the default word length of 16 bits and unspecified scaling.

Create a `numerictype` Object with Unspecified Scaling

This example shows how to create a `numerictype` object with unspecified scaling by omitting the fraction length argument, `f`.

```
T = numerictype(1,32)
```

T =

```

DataTypeMode: Fixed-point: unspecified scaling
Signedness: Signed
WordLength: 32

```

The object is signed, with a 32-bit word length.

Create a numerictype Object with Specified Word and Fraction Length

This example shows how to create a signed numerictype object with binary-point scaling, a 32-bit word length, and 30-bit fraction length.

```
T = numerictype(1,32,30)
```

T =

```

DataTypeMode: Fixed-point: binary point scaling
Signedness: Signed
WordLength: 32
FractionLength: 30

```

Create a numerictype Object with Slope and Bias Scaling

This example shows how to create a numerictype object with slope and bias scaling. The real-world value of a slope and bias scaled number is represented by:

$$\text{realworldvalue} = (\text{slope} \times \text{integer}) + \text{bias}$$

Create a numerictype object that describes a signed, fixed-point data type with a word length of 16 bits, a slope of 2^{-2} , and a bias of 4.

```
T = numerictype(1,16,2^-2,4)
```

T =

```

DataTypeMode: Fixed-point: slope and bias scaling
Signedness: Signed
WordLength: 16
Slope: 0.25
Bias: 4

```

Alternatively, the slope can be represented by:

$$\text{slope} = \text{slopeadjustmentfactor} \times 2^{\text{fixedexponent}}$$

Create a numerictype object that describes a signed, fixed-point data type with a word length of 16 bits, a slope adjustment factor of 1, a fixed exponent of -2, and a bias of 4.

```
T = numerictype(1,16,1,-2,4)
```

T =

```
DataTypeMode: Fixed-point: slope and bias scaling
Signedness: Signed
WordLength: 16
Slope: 0.25
Bias: 4
```

Create a numeric type Object with Specified Property Values

This example shows how to use name-value pairs to set numeric type properties at object creation.

```
T = numericType('Signed',true,'DataTypeMode','Fixed-point: slope and bias scaling', ...
    'WordLength',32,'Slope',2^-2,'Bias',4)
```

T =

```
DataTypeMode: Fixed-point: slope and bias scaling
Signedness: Signed
WordLength: 32
Slope: 0.25
Bias: 4
```

Create a numeric type Object with Unspecified Sign

This example shows how to create a numeric type object with an unspecified sign by using name-value pairs to set the Signedness property to Auto.

```
T = numericType('Signedness','Auto')
```

T =

```
DataTypeMode: Fixed-point: binary point scaling
Signedness: Auto
WordLength: 16
FractionLength: 15
```

Create a numeric type Object with Specified Data Type

This example shows how to create a numeric type object with a specific data type by using arguments and name-value pairs.

```
T = numericType(0,24,12,'DataType','ScaledDouble')
```

T =

```

    DataTypeMode: Scaled double: binary point scaling
    Signedness: Unsigned
    WordLength: 24
    FractionLength: 12

```

The returned `numerictype` object, `T`, is unsigned, and has a word length of 24 bits, a fraction length of 12 bits, and a data type set to scaled double.

Create a Double, Single, Half, or Boolean `numerictype` Object

This example shows how to create a `numerictype` object with data type set to double, single, half, or Boolean at object creation.

Create a `numerictype` object with the data type mode set to double.

```

T = numerictype('Double')
T =

```

```

    DataTypeMode: Double

```

Create a `numerictype` object with the data type mode set to single.

```

T = numerictype('Single')
T =

```

```

    DataTypeMode: Single

```

Create a `numerictype` object with the data type mode set to half.

```

T = numerictype('Half')
T =

```

```

    DataTypeMode: Half

```

Create a `numerictype` object with the data type mode set to Boolean.

```

T = numerictype('Boolean')
T =

```

```

    DataTypeMode: Boolean

```

Input Arguments

s — Whether object is signed

true or 1 (default) | false or 0

Whether the object is signed, specified as a numeric or logical 1 (true) or 0 (false).

Example: `T = numerictype(true)`

Data Types: `logical`

w – Word length

16 (default) | positive integer

Word length, in bits, of the stored integer value, specified as a positive integer.

Example: `T = numerictype(true,16)`

Data Types: `half | single | double | int8 | int16 | int32 | int64 | uint8 | uint16 | uint32 | uint64`

f – Fraction length

15 (default) | integer

Fraction length, in bits, of the stored integer value, specified as an integer.

Fraction length can be greater than word length. For more information, see “Binary Point Interpretation” (Fixed-Point Designer).

Example: `T = numerictype(true,16,15)`

Data Types: `half | single | double | int8 | int16 | int32 | int64 | uint8 | uint16 | uint32 | uint64`

slope – Slope

3.0518e-05 (default) | finite floating-point number greater than zero

Slope, specified as a finite floating-point number greater than zero.

The slope and the bias determine the scaling of a fixed-point number.

Note

$$\text{slope} = \text{slopeadjustmentfactor} \times 2^{\text{fixedexponent}}$$

Changing one of these properties affects the others.

Example: `T = numerictype(true,16,2^-2,4)`

Data Types: `half | single | double | int8 | int16 | int32 | int64 | uint8 | uint16 | uint32 | uint64`

bias – Bias associated with object

0 (default) | floating-point number

Bias associated with the object, specified as a floating-point number.

The slope and the bias determine the scaling of a fixed-point number.

Example: `T = numerictype(true,16,2^-2,4)`

Data Types: `half | single | double | int8 | int16 | int32 | int64 | uint8 | uint16 | uint32 | uint64`

slopeadjustmentfactor — Slope adjustment factor

1 (default) | positive scalar

Slope adjustment factor, specified as a positive scalar.

The slope adjustment factor must be greater than or equal to 1 and less than 2. If you input a `slopeadjustmentfactor` outside this range, the `numerictype` object automatically applies a scaling normalization to the values of `slopeadjustmentfactor` and `fixedexponent` so that the revised slope adjustment factor is greater than or equal to 1 and less than 2, and maintains the value of the slope.

The slope adjustment is equivalent to the fractional slope of a fixed-point number.

Note

$$\text{slope} = \text{slopeadjustmentfactor} \times 2^{\text{fixedexponent}}$$

Changing one of these properties affects the others.

Data Types: half | single | double | int8 | int16 | int32 | int64 | uint8 | uint16 | uint32 | uint64

fixedexponent — Fixed-point exponent

-15 (default) | integer

Fixed-point exponent associated with the object, specified as an integer.

Note The `FixedExponent` property is the negative of the `FractionLength`. Changing one property changes the other.

Data Types: half | single | double | int8 | int16 | int32 | int64 | uint8 | uint16 | uint32 | uint64

Name-Value Pair Arguments

Specify optional comma-separated pairs of `Name`, `Value` arguments. `Name` is the argument name and `Value` is the corresponding value. `Name` must appear inside quotes. You can specify several name and value pair arguments in any order as `Name1, Value1, ..., NameN, ValueN`.

Example: `F = numerictype('DataTypeMode','Fixed-point: binary point scaling','DataTypeOverride','Inherit')`

Note When you create a `numerictype` object by using name-value pairs, Fixed-Point Designer creates a default `numerictype` object, and then, for each property name you specify in the constructor, assigns the corresponding value. This behavior differs from the behavior that occurs when you use a syntax such as `T = numerictype(s,w)`. See “Example: Construct a `numerictype` Object with Property Name and Property Value Pairs”.

Bias — Bias

0 (default) | floating-point number

Bias, specified as a floating-point number.

The slope and bias determine the scaling of a fixed-point number.

Example: `T = numericitype('DataTypeMode','Fixed-point: slope and bias scaling','Bias',4)`

Data Types: `half | single | double | int8 | int16 | int32 | int64 | uint8 | uint16 | uint32 | uint64`

DataType — Data type category

`'Fixed'` (default) | `'Boolean'` | `'Double'` | `'ScaledDouble'` | `'Single'` | `'Half'`

Data type category, specified as one of these values:

- `'Fixed'` - Fixed-point or integer data type
- `'Boolean'` - Built-in MATLAB Boolean data type
- `'Double'` - Built-in MATLAB double data type
- `'ScaledDouble'` - Scaled double data type
- `'Single'` - Built-in MATLAB single data type
- `'Half'` - MATLAB half-precision data type

Example: `T = numericitype('Double')`

Data Types: `char`

DataTypeMode — Data type and scaling mode

`'Fixed-point: binary point scaling'` (default) | `'Fixed-point: slope and bias scaling'` | `'Fixed-point: unspecified scaling'` | `'Scaled double: binary point scaling'` | `'Scaled double: slope and bias scaling'` | `'Scaled double: unspecified scaling'` | `'Double'` | `'Single'` | `'Half'` | `'Boolean'`

Data type and scaling mode associated with the object, specified as one of these values:

- `'Fixed-point: binary point scaling'` - Fixed-point data type and scaling defined by the word length and fraction length
- `'Fixed-point: slope and bias scaling'` - Fixed-point data type and scaling defined by the slope and bias
- `'Fixed-point: unspecified scaling'` - Fixed-point data type with unspecified scaling
- `'Scaled double: binary point scaling'` - Double data type with fixed-point word length and fraction length information retained
- `'Scaled double: slope and bias scaling'` - Double data type with fixed-point slope and bias information retained
- `'Scaled double: unspecified scaling'` - Double data type with unspecified fixed-point scaling
- `'Double'` - Built-in double
- `'Single'` - Built-in single
- `'Half'` - MATLAB half-precision data type
- `'Boolean'` - Built-in boolean

Example: `T = numericitype('DataTypeMode','Fixed-point: binary point scaling')`

Data Types: char

DataTypeOverride — Data type override settings

'Inherit' (default) | 'Off'

Data type override settings, specified as one of these values:

- 'Inherit' - Turn on DataTypeOverride
- 'Off' - Turn off DataTypeOverride

Note The DataTypeOverride property is not visible when its value is set to the default, 'Inherit'.

Example: `T = numerictype('DataTypeOverride','Off')`

Data Types: char

FixedExponent — Fixed-point exponent

-15 (default) | integer

Fixed-point exponent associated with the object, specified as an integer.

Note The FixedExponent property is the negative of the FractionLength. Changing one property changes the other.

Example: `T = numerictype('FixedExponent',-12)`

Data Types: half | single | double | int8 | int16 | int32 | int64 | uint8 | uint16 | uint32 | uint64

FractionLength — Fraction length of the stored integer value

best precision (default) | integer

Fraction length, in bits, of the stored integer value, specified as an integer.

The default value is the best precision fraction length based on the value of the object and the word length.

Example: `T = numerictype('FractionLength',12)`

Data Types: half | single | double | int8 | int16 | int32 | int64 | uint8 | uint16 | uint32 | uint64

Scaling — Fixed-point scaling mode

'BinaryPoint' (default) | 'SlopeBias' | 'Unspecified'

Fixed-point scaling mode of the object, specified as one of these values:

- 'BinaryPoint' - Scaling for the numerictype object is defined by the fraction length.
- 'SlopeBias' - Scaling for the numerictype object is defined by the slope and bias.
- 'Unspecified' - Temporary setting that is only allowed at numerictype object creation, and allows for the automatic assignment of a best-precision binary point scaling.

Example: `T = numericitype('Scaling','BinaryPoint')`

Data Types: `char`

Signed — Whether the object is signed

`true` or `1` (default) | `false` or `0`

Whether the object is signed, specified as a numeric or logical `1` (`true`) or `0` (`false`).

Note Although the `Signed` property is still supported, the `Signedness` property always appears in the `numericitype` object display. If you choose to change or set the signedness of your `numericitype` object using the `Signed` property, MATLAB updates the corresponding value of the `Signedness` property.

Example: `T = numericitype('Signed',true)`

Data Types: `logical`

Signedness — Whether the object is signed

`'Signed'` (default) | `'Unsigned'` | `'Auto'`

Whether the object is signed, specified as one of these values:

- `'Signed'` - Signed
- `'Unsigned'` - Unsigned
- `'Auto'` - Unspecified sign

Note Although you can create `numericitype` objects with an unspecified sign (`Signedness: Auto`), all fixed-point `numericitype` objects must have a `Signedness` of `Signed` or `Unsigned`. If you use a `numericitype` object with `Signedness: Auto` to construct a `numericitype` object, the `Signedness` property of the `numericitype` object automatically defaults to `Signed`.

Example: `T = numericitype('Signedness','Signed')`

Data Types: `char`

Slope — Slope

`3.0518e-05` (default) | finite, positive floating-point number

Slope, specified as a finite, positive floating-point number.

The slope and bias determine the scaling of a fixed-point number.

Note

$$\text{slope} = \text{slope adjustment factor} \times 2^{\text{fixed exponent}}$$

Changing one of these properties affects the others.

Example: `T = numericitype('DataTypeMode','Fixed-point: slope and bias scaling','Slope',2^-2)`

Data Types: half | single | double | int8 | int16 | int32 | int64 | uint8 | uint16 | uint32 | uint64

SlopeAdjustmentFactor — Slope adjustment factor

1 (default) | positive scalar

Slope adjustment factor, specified as a positive scalar.

The slope adjustment factor must be greater than or equal to 1 and less than 2. If you input a `slopeadjustmentfactor` outside this range, the `numerictype` object automatically applies a scaling normalization to the values of `slopeadjustmentfactor` and `fixedexponent` so that the revised slope adjustment factor is greater than or equal to 1 and less than 2, and maintains the value of the slope.

The slope adjustment is equivalent to the fractional slope of a fixed-point number.

Note

$$\text{slope} = \text{slopeadjustmentfactor} \times 2^{\text{fixedexponent}}$$

Changing one of these properties affects the others.

Example: `T = numerictype('DataTypeMode','Fixed-point: slope and bias scaling','SlopeAdjustmentFactor',1.5)`

Data Types: half | single | double | int8 | int16 | int32 | int64 | uint8 | uint16 | uint32 | uint64

WordLength — Word length of the stored integer value

16 (default) | positive integer

Word length, in bits, of the stored integer value, specified as a positive integer.

Example: `T = numerictype('WordLength',16)`

Data Types: half | single | double | int8 | int16 | int32 | int64 | uint8 | uint16 | uint32 | uint64

Extended Capabilities

C/C++ Code Generation

Generate C and C++ code using MATLAB® Coder™.

Usage notes and limitations:

- Fixed-point signals coming in to a MATLAB Function block from Simulink are assigned a `numerictype` object that is populated with the signal's data type and scaling information.
- Returns the data type when the input is a non fixed-point signal.
- Use to create `numerictype` objects in generated code.
- All `numerictype` object properties related to the data type must be constant.

HDL Code Generation

Generate Verilog and VHDL code for FPGA and ASIC designs using HDL Coder™.

See Also

fi | fimath | fipref | quantizer

Topics

“numerictype Objects Usage to Share Data Type and Scaling Settings of fi objects”

“numerictype Object Properties”

Introduced before R2006a

NumericTypeScope

Determine fixed-point data type

Syntax

```
H = NumericTypeScope
show(H)
step(H, data)
release(H)
reset(H)
```

Description

The `NumericTypeScope` is an object that provides information about the dynamic range of your data. The scope provides a visual representation of the dynamic range of your data in the form of a \log_2 histogram. In this histogram, the bit weights appear along the X-axis, and the percentage of occurrences along the Y-axis. Each bin of the histogram corresponds to a bit in the binary word. For example, 2^0 corresponds to the first integer bit in the binary word, 2^{-1} corresponds to the first fractional bit in the binary word.

The scope suggests a data type in the form of a `numericType` object that satisfies the specified criteria. See the section on Bit Allocation in “Dialog Panels” on page 4-628.

`H = NumericTypeScope` returns a `NumericTypeScope` object that you can use to view the dynamic range of data in MATLAB. To view the `NumericTypeScope` window after creating *H*, use the `show` method.

`show(H)` opens the `NumericTypeScope` object *H* and brings it into view. Closing the scope window does not delete the object from your workspace. If the scope object still exists in your workspace, you can open it and bring it back into view using the `show` method.

`step(H, data)` processes your data and allows you to visualize the dynamic range. The object *H* retains previously collected information about the variable between each call to `step`.

`release(H)` releases system resources (such as memory, file handles or hardware connections) and allows all properties and input characteristics to be changed.

`reset(H)` clears all stored information from the `NumericTypeScope` object *H*. Resetting the object clears the information displayed in the scope window.

Identifying Values Outside Range and Below Precision

The `NumericTypeScope` can also help you identify any values that are outside range or below precision based on the current data type. To prepare the `NumericTypeScope` to identify them, provide an input variable that is a `fi` object and verify that one of the following conditions is true:

- The `DataTypeMode` of the `fi` object is set to `Scaled doubles: binary point scaling`.
- The `DataTypeOverride` property of the Fixed-Point Designer `fipref` object is set to `ScaledDoubles`.

When the information is available, the scope indicates values that are outside range, below precision, and in range of the data type by color-coding the histogram bars as follows:

- Blue — Histogram bin contains values that are in range of the current data type.
- Red — Histogram bin contains values that are outside range in the current data type.
- Yellow — Histogram bin contains values that are below precision in the current data type.

For an example of the scope color coding, see the figures in “Vertical Units” on page 4-630.

See also Legend in “Dialog Panels” on page 4-628.

See the “Examples” on page 4-0 section to learn more about using the `NumericTypeScope` to select data types.

Dialog Boxes and Toolbar

- “The `NumericTypeScope` Window” on page 4-624
- “Configuration Dialog Box” on page 4-626
- “Dialog Panels” on page 4-628
- “Vertical Units” on page 4-630
- “Bring All `NumericType` Scope Windows Forward” on page 4-631
- “Toolbar (Mac Only)” on page 4-632

The `NumericTypeScope` Window

The `NumericTypeScope` opens with the default toolbars displayed at the top of the window and the dialog panels to the right.

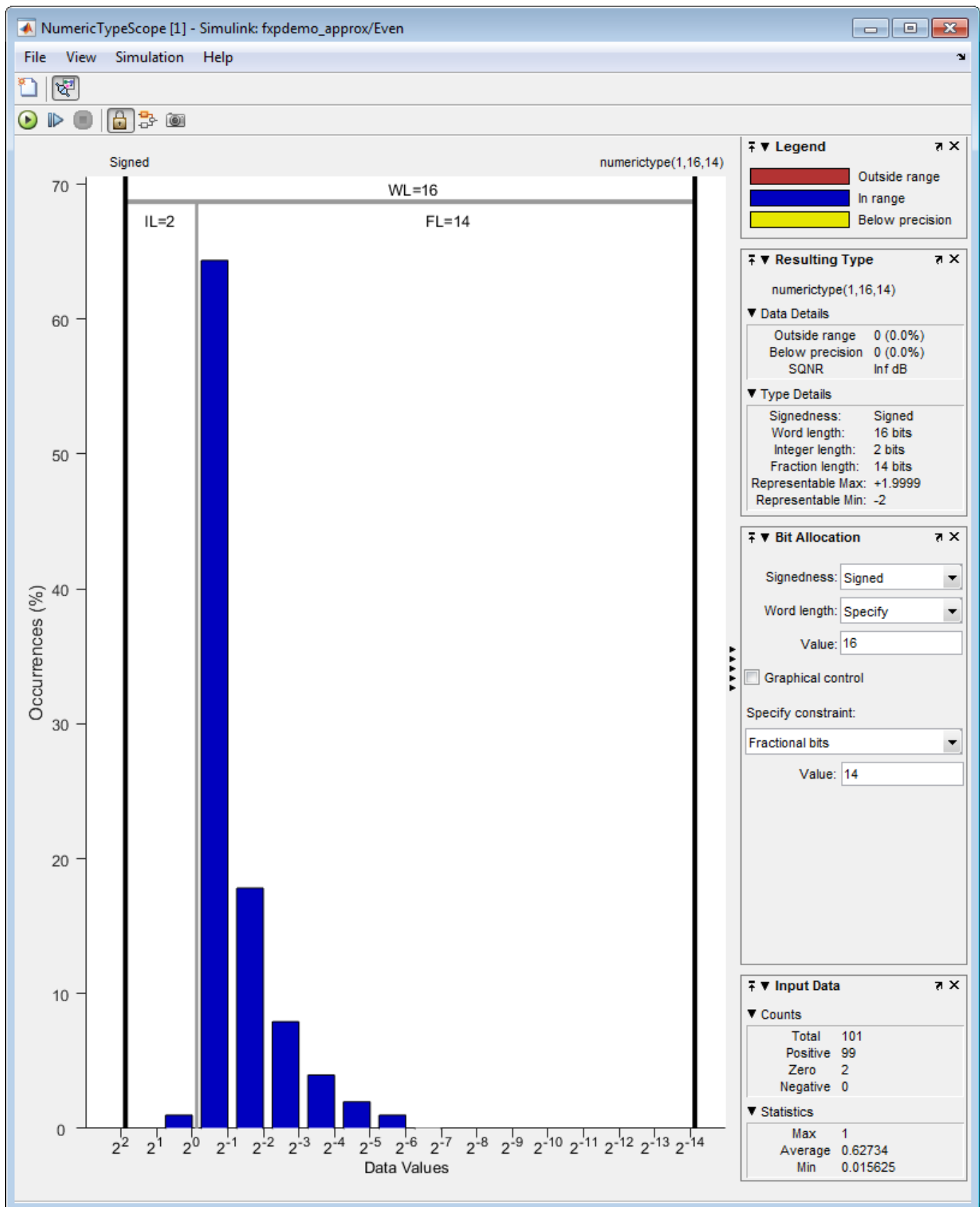

Configuration Dialog Box

The `NumericTypeScope` configuration allows you to control the behavior and appearance of the scope window.

To open the Configuration dialog box, select **File > Configuration**, or, with the scope as your active window, press the **N** key.

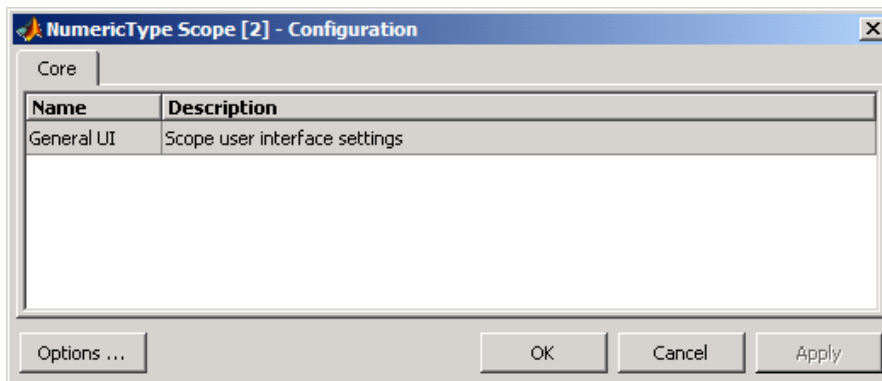

The Configuration Dialog box contains a series of panes each containing a table of configuration options. See the reference section for each pane for instructions on setting the options on each one. This dialog box has one pane, the Core pane, with only one option, for General UI settings for the scope user interface.

To save configuration settings for future use, select **File > Configuration > Save as**. The configuration settings you save become the default configuration settings for the `NumericTypeScope` object.

Caution Before saving your own set of configuration settings in the `matlab/toolbox/fixedpoint/fixedpoint` folder, save a backup copy of the default configuration settings in another location. If you do not save a backup copy of the default configuration settings, you cannot restore these settings at a later time.

To save your configuration settings for future use, save them in the `matlab/toolbox/fixedpoint/fixedpoint` folder with the file name `NumericTypeScopeComponent.cfg`. You can re-save your configuration settings at anytime, but remember to do so in the specified folder using the specified file name.

Core Pane

The Core pane in the Configuration dialog box controls the general settings of the scope.

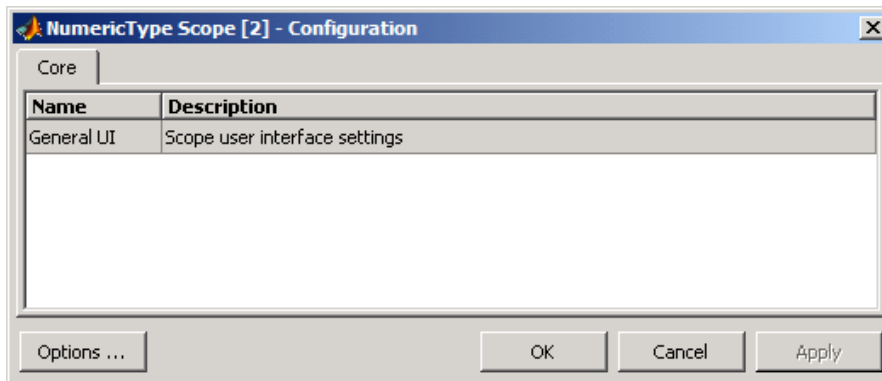

Click General UI and then click **Options** to open the Core:General UI Options dialog box.

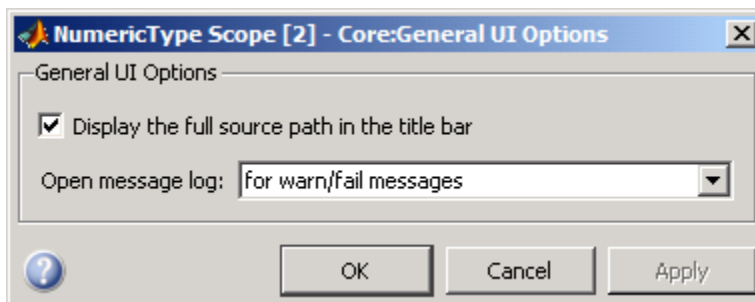

- **Display the full source path in the title bar**—Select this check box to display the file name and variable name in the scope title bar. If the scope is not from a file, or if you clear this check box, the scope displays only the variable name in the title bar.
- **Open message log**—Control when the Message Log window opens. The Message log window helps you debug issues with the scope. Choose to open the Message Log window for any of these conditions:
 - for any new messages
 - for warn/fail messages
 - only for fail messages
 - manually

The option defaults to for warn/fail messages.

You can open the Message Log at any time by selecting **Help > Message Log** or by pressing **Ctrl +M**. The Message Log dialog box provides a system level record of loaded configuration settings and registered extensions. The Message Log displays summaries and details of each message, and you can filter the display of messages by Type and Category.

- **Type**—Select the type of messages to display in the Message Log. You can select All, Info, Warn, or Fail. Type defaults to All.
- **Category**—Select the category of messages to display in the Message Log. You can select All, Configuration, or Extension. The scope uses Configuration messages to indicate when new configuration files are loaded, and Extension messages to indicate when components are registered. Category defaults to All.

Dialog Panels

- “Bit Allocation” on page 4-628
- “Legend” on page 4-628
- “Resulting Type” on page 4-629
- “Input Data” on page 4-629

Bit Allocation

The scope Bit Allocation dialog panel, as shown in the following figure, offers you several options for specifying data type criteria.

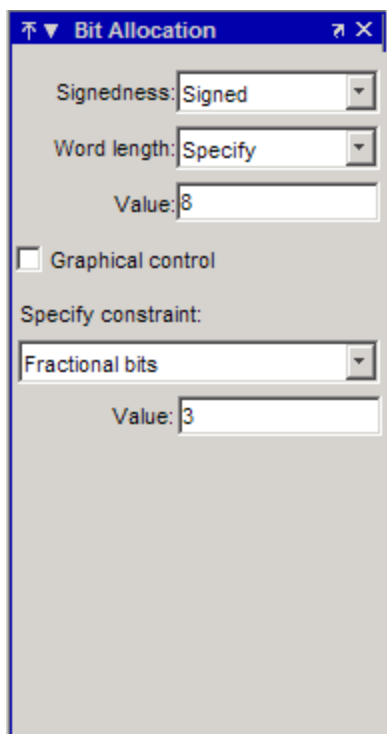

You can use this panel to specify a known word length and the desired maximum occurrences outside range. You can also use the panel to specify the desired number of occurrences outside range and the smallest value to be represented by the suggested data type. For streaming data, the suggested numerictype object adjusts over time in order to continue to satisfy the specified criteria.

The scope also allows you to interact with the histogram plot. When you select **Graphical control** on the Bit Allocation dialog panel, you enable cursors on either side of the binary point. You can interact with these cursors and observe the effect of the suggested numerictype on the input data. For example, you can see the number of values that are outside range, below precision, or both. You can also view representable minimum and maximum values of the data type.

Legend

The scope Legend panel informs you which colors the scope uses to indicate values. These colors represent values that are outside range, in range, or below precision when displayed in the scope.

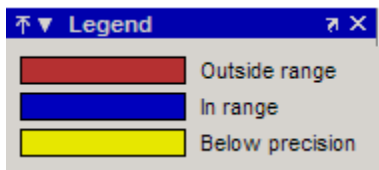

Resulting Type

The Resulting Type panel describes the fixed-point data type as defined by scope settings. By manipulating the visual display (via the Bit Allocation panel or with the cursors) you can change the value of the data type.

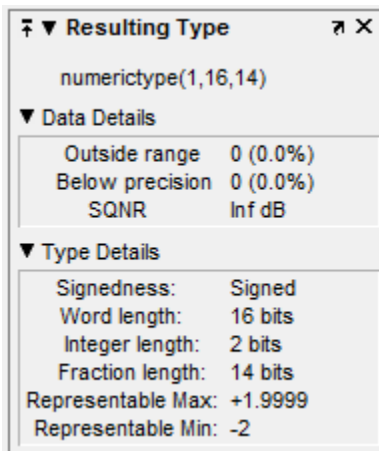

The Data Details section displays the percentage of values that fall outside range or below precision with the `numeric type` object located at the top of this panel. SQNR (Signal Quantization Noise Ratio) varies depending on the signal. If the parameter has no value, then there is not enough data to calculate the SQNR. When scope information or the `numeric type` changes, the SQNR resets.

Type Details section provides details about the fixed-point data type.

Input Data

The Input Data panel provides statistical information about the values currently displayed in the `NumericScopeType` object.

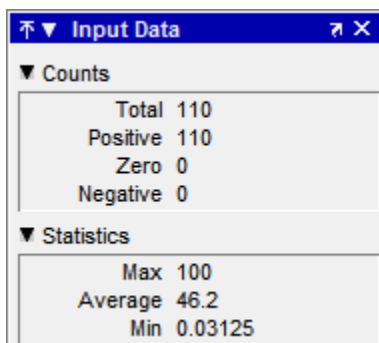

Vertical Units

Use the Vertical Units selection to display values that are outside range or below precision as a percentage or as an actual count. For example, the following image shows the values that are outside range or below precision as a percentage of the total values.

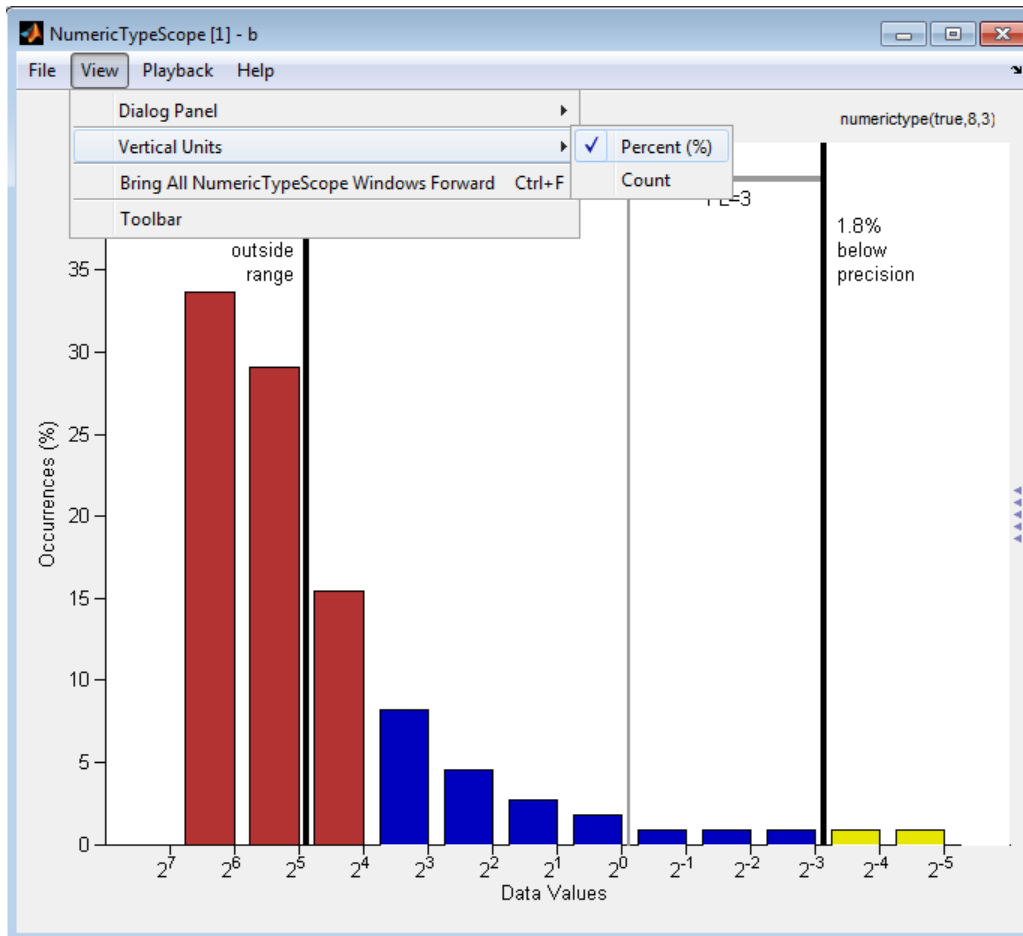

This next example shows the values that are outside range or below precision as an actual count.

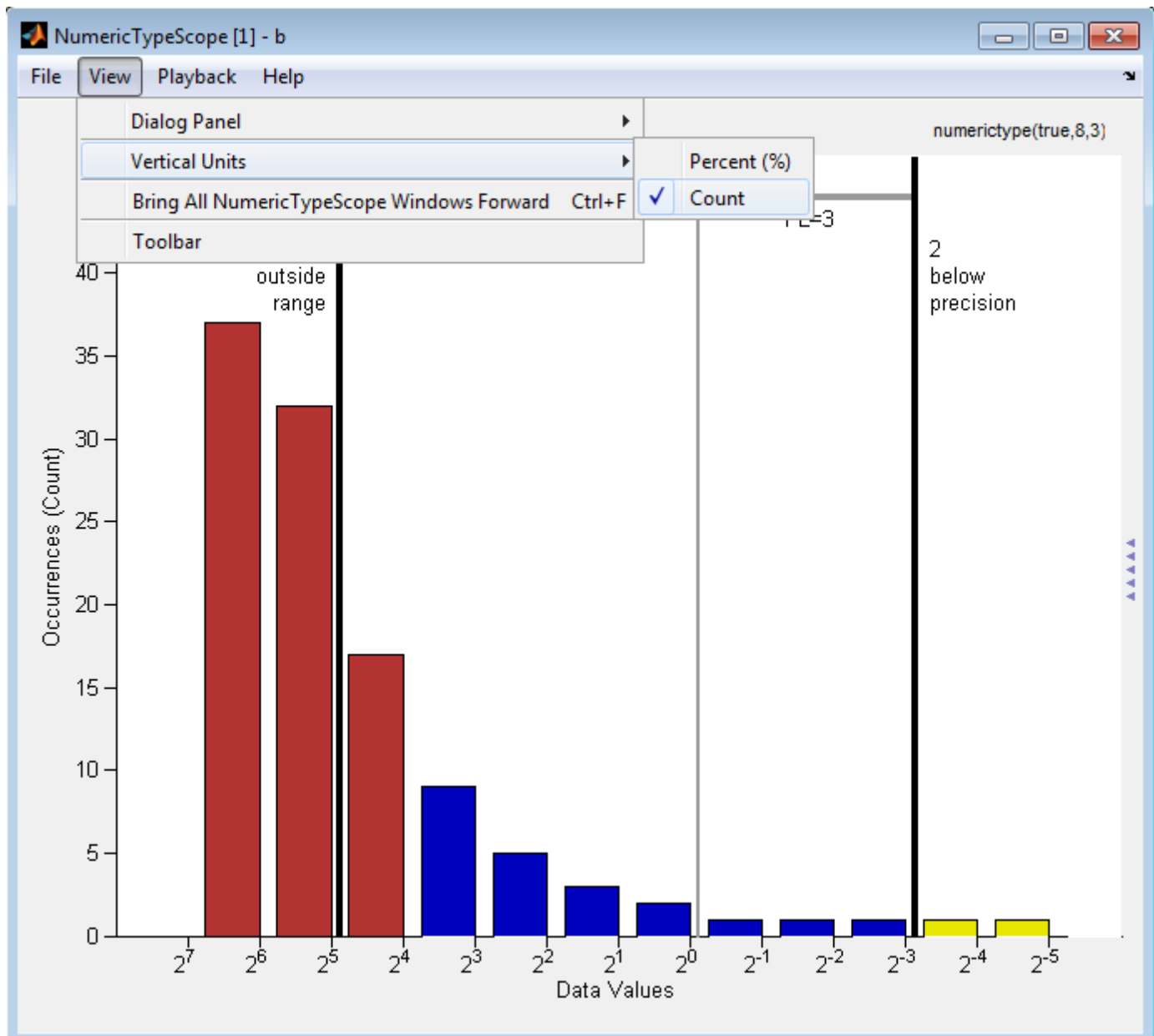

Bring All NumericType Scope Windows Forward

The NumericScopeType GUI offers a **View > Bring All NumericType Scopes Forward** menu option to help you manage your NumericTypeScope windows. Selecting this option or pressing **Ctrl +F** brings all NumericTypeScope windows into view. If a NumericTypeScope window is not currently open, this menu option opens the window and brings it into view.

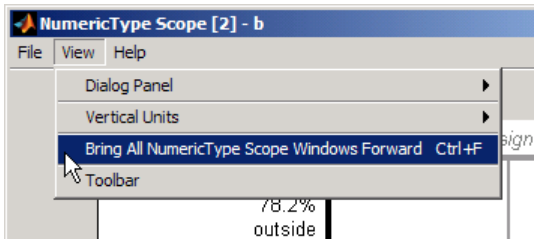

Toolbar (Mac Only)

Activate the Toolbar by selecting **View > Toolbar**. When this tool is active, you can dock or undock the scope from the GUI.

The toolbar feature is for the Mac only. Selecting **Toolbar** on Windows® and UNIX® versions displays only an empty toolbar. The docking icon always appears in the GUI in the upper-right corner for these versions.

Methods

release

Use this method to release system resources (such as memory, file handles or hardware connections) and allow all properties and input characteristics to be changed.

Example:

```
>>release(H)
```

reset

Use this method to clear the information stored in the object *H*. Doing so allows you to reuse *H* to process data from a different variable.

Example:

```
>>reset(H)
```

show

Use this method to open the scope window and bring it into view.

Example:

```
>>show(H)
```

step

Use this method to process your data and visualize the dynamic range in the scope window.

Example:

```
>>step(H, data)
```

Examples

View the Dynamic Range of a fi Object

Set the fi object `DataTypeOverride` to Scaled Doubles, and then view its dynamic range.

```
fp = fipref;
initialDT0Setting = fp.DataTypeOverride;
fp.DataTypeOverride = 'ScaledDoubles';
a = fi(magic(10),1,8,2);
b = fi([a; 2.^(-5:4)],1,8,3);
h = NumericTypeScope;
step(h,b);
fp.DataTypeOverride = initialDT0Setting;
```

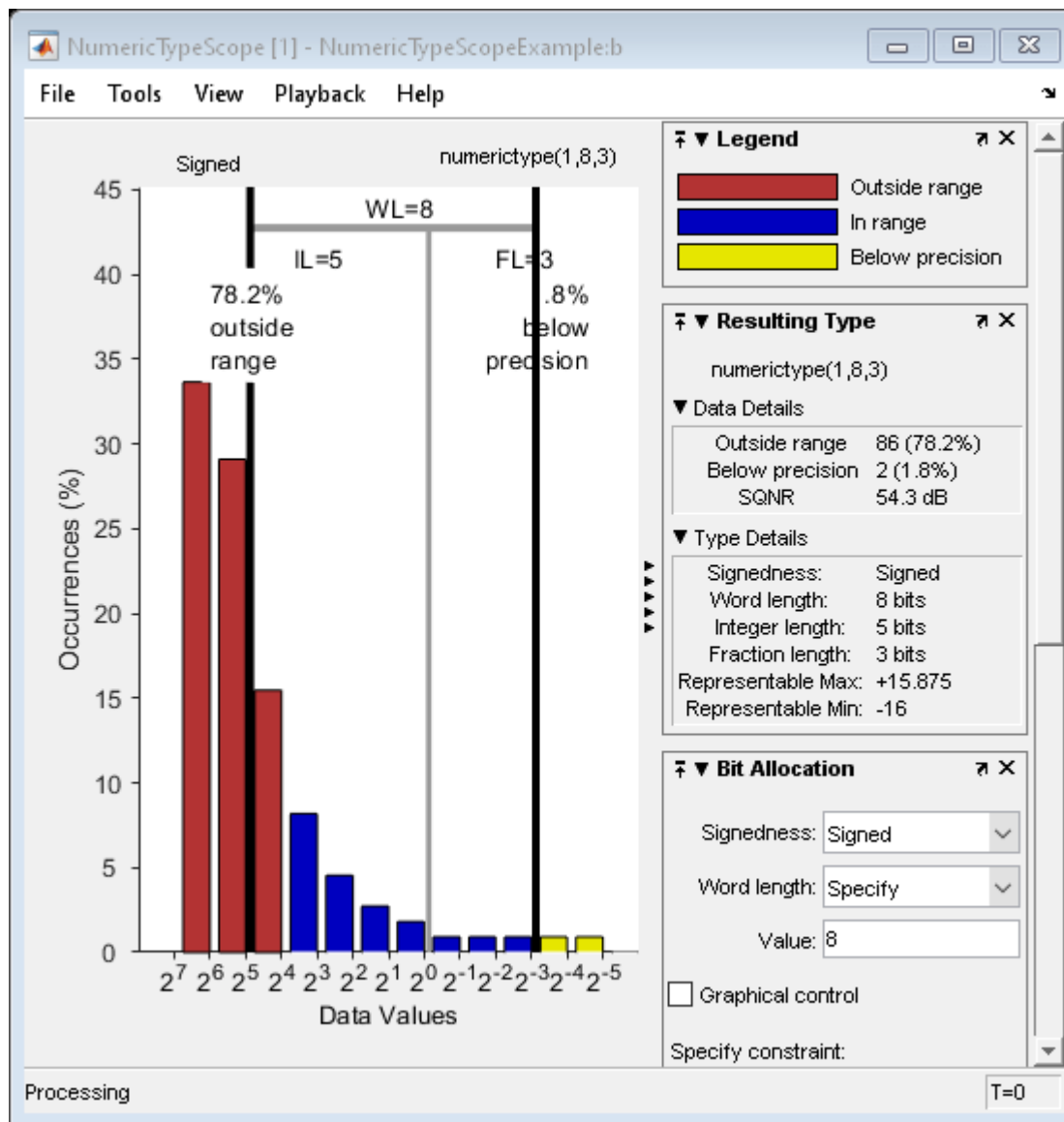

The log₂ histogram display shows that the values appear both outside range and below precision in the variable. In this case, `b` has a data type of `numerictype(1,8,3)`. The `numerictype(1,8,3)` data type provides 5 integer bits (including the signed bit), and 3 fractional bits. Thus, this data type can

represent only values between -2^4 and $2^4 - 2^{-3}$ (from -16 to 15.8750). Given the range and precision of this data type, values greater than 2^4 fall outside the range and values less than 2^{-3} fall below the precision of the data type. When you examine the `NumericTypeScope` display, you can see that values requiring bits 5, 6, and 7 are outside range and values requiring fractional bits 4 and 5 are below precision. Given this information, you can prevent values that are outside range and below precision by changing the data type of the variable `b` to `numerictype(0,13,5)`.

Determine Numeric Type For a fi Object

View the dynamic range, and determine an appropriate numeric type for a `fi` object with a `DataTypeMode` of Scaled double: binary point scaling.

Create a `numerictype` object with a `DataTypeMode` of Scaled double: binary point scaling. You can then use that `numerictype` object to construct your `fi` objects. Because you set the `DataTypeMode` to Scaled double: binary point scaling, the `NumericTypeScope` can now identify overflows in your data.

```
T = numerictype;
T.DataTypeMode = 'Scaled double: binary point scaling';
T.WordLength = 8;
T.FractionLength = 6;
a = fi(sin(0:100)*3.5, T);
b = fi(cos(0:100)*1.75,T);
acc = fi(0,T);
h = NumericTypeScope;
for i = 1:length(a)
    acc(:) = a(i)*0.7+b(i);
    step(h,acc)
end
```

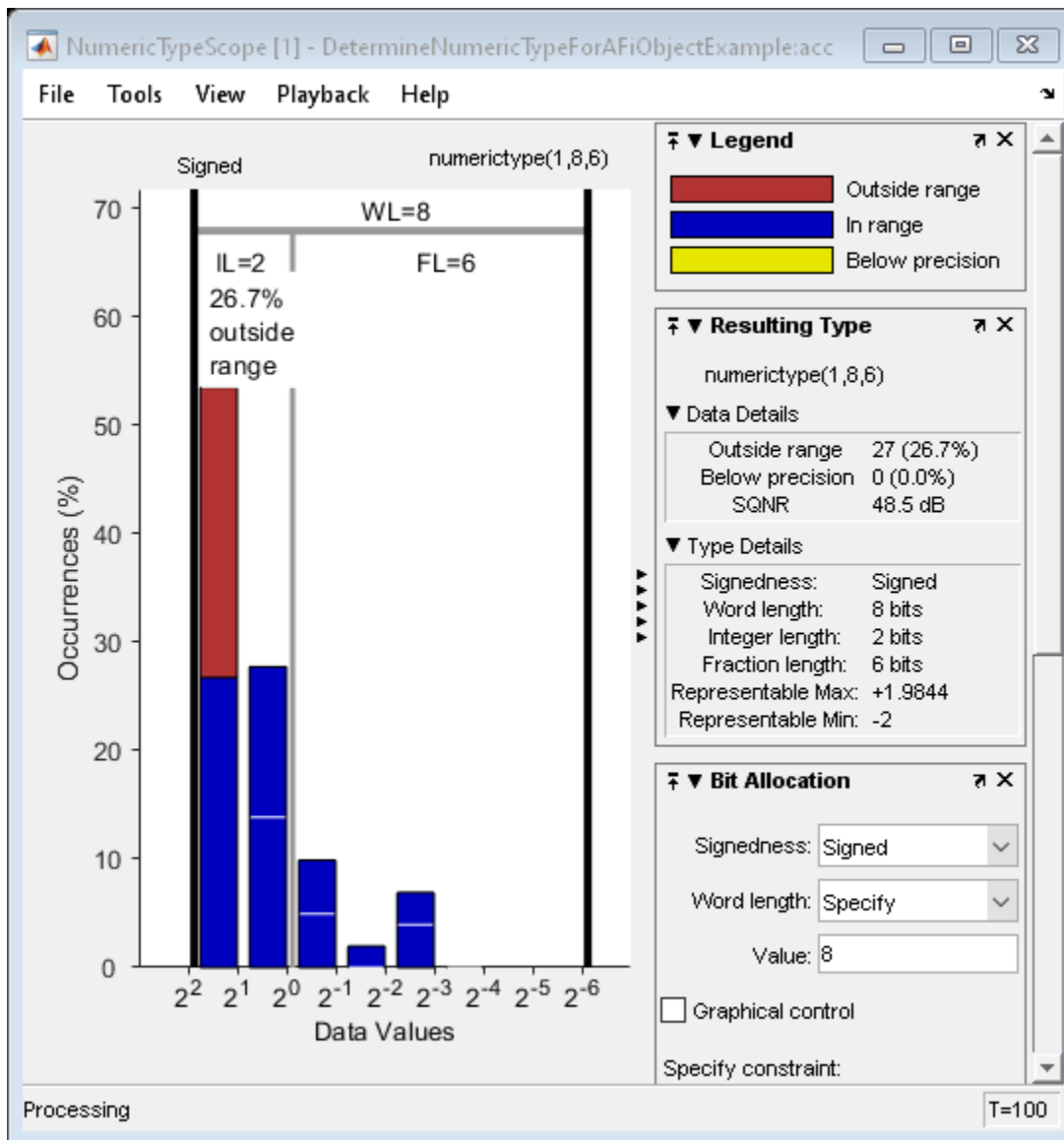

This dynamic range analysis shows that you can represent the entire range of data in the accumulator with 5 bits; two to the left of the binary point (integer bits) and three to the right of it (fractional bits). You can verify that this data type is able to represent all the values by changing the WordLength and FractionLength properties of the numerictype object T. Then, use T to redefine the accumulator.

To view the dynamic range analysis based on this new data type, reset the NumericTypeScope object h, and rerun the loop.

```
T.WordLength = 5;
T.FractionLength = 2;
acc = fi(0,T);
release(h)
reset(h)
for i = 1:length(a)
    acc(:) = a(i)*0.7 + b(i);
```

```

step(h, acc)
end

```

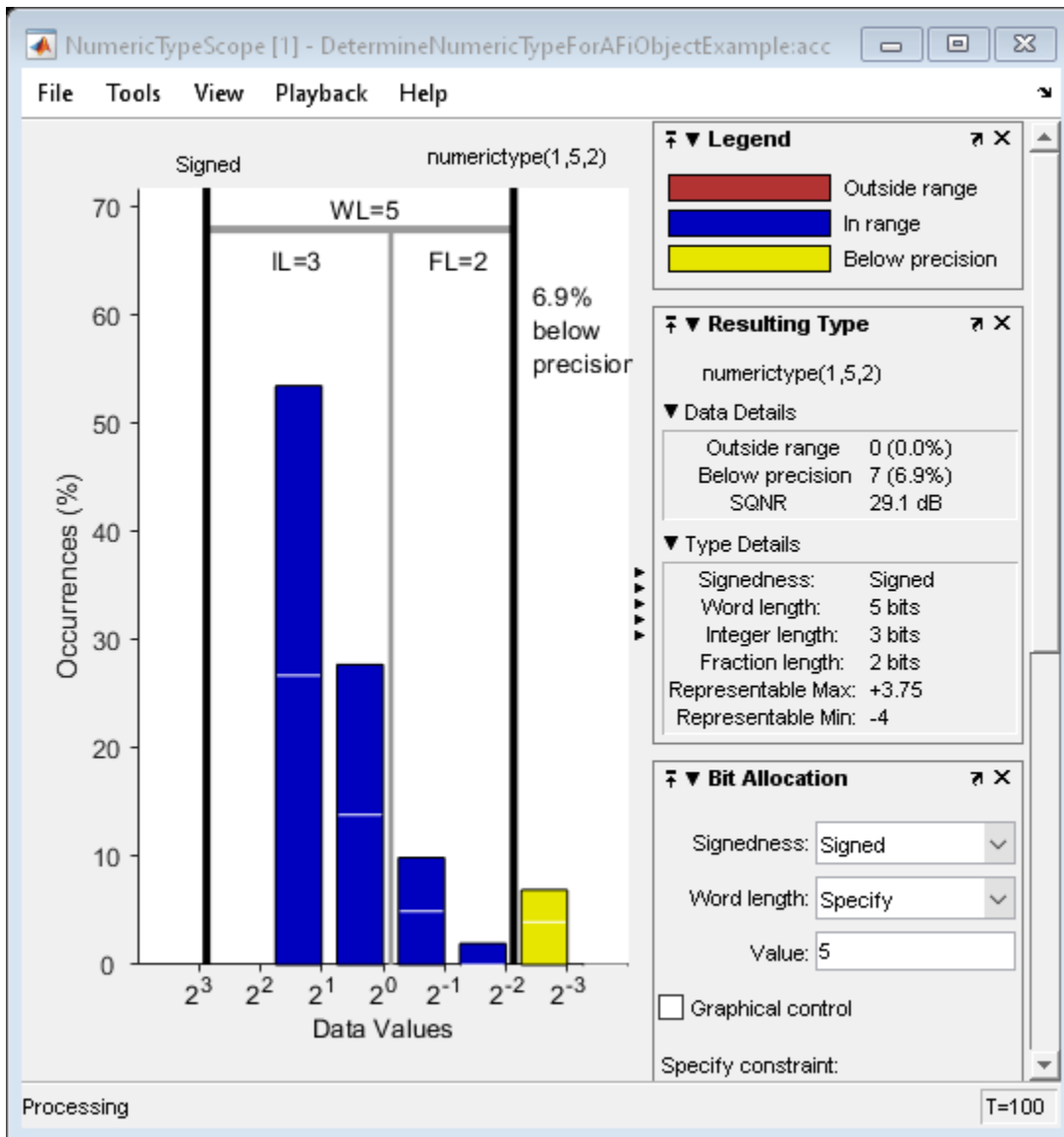

See Also

hist | log2

Introduced in R2010a

nunderflows

Number of underflows

Syntax

```
y = nunderflows(a)  
y = nunderflows(q)
```

Description

`y = nunderflows(a)` returns the number of underflows of `fi` object `a` since logging was turned on or since the last time the log was reset for the object.

Turn on logging by setting the `fipref` property `LoggingMode` to `on`. Reset logging for a `fi` object using the `resetlog` function.

`y = nunderflows(q)` returns the accumulated number of underflows resulting from quantization operations performed by a quantizer object `q`.

See Also

`maxlog` | `minlog` | `noverflows` | `resetlog`

Introduced before R2006a

oct

Octal representation of stored integer of `fi` object

Syntax

```
b = oct(a)
```

Description

`b = oct(a)` returns the stored integer of `fi` object `a` in octal format as a character vector.

Fixed-point numbers can be represented as

$$\text{real-worldvalue} = 2^{-\text{fractionlength}} \times \text{storedinteger}$$

or, equivalently as

$$\text{real-worldvalue} = (\text{slope} \times \text{storedinteger}) + \text{bias}$$

The stored integer is the raw binary number, in which the binary point is assumed to be at the far right of the word.

Examples

View Stored Integer of `fi` Object in Octal Format

Create a signed `fi` object with values -1 and 1, a word length of 8 bits, and a fraction length of 7 bits.

```
a = fi([-1 1], 1, 8, 7)
```

```
a=1x2 object
```

```
-1.0000    0.9922
```

```
      DataTypeMode: Fixed-point: binary point scaling  
      Signedness: Signed  
      WordLength: 8  
      FractionLength: 7
```

Find the octal representation of the stored integers of `fi` object `a`.

```
b = oct(a)
```

```
b =  
'200    177'
```

Input Arguments

a — **fi** object to view in octal

fi object

Input fi object to view in octal.

Data Types: fi

See Also

bin | dec | hex | storedInteger

Introduced before R2006a

ones

Create array of all ones with fixed-point properties

Syntax

```
X = ones('like',p)
X = ones(n,'like',p)
X = ones(sz1,...,szN,'like',p)
X = ones(sz,'like',p)
```

Description

`X = ones('like',p)` returns a scalar 1 with the same numeric type, complexity (real or complex), and `fimath` as `p`.

`X = ones(n,'like',p)` returns an `n`-by-`n` array of ones like `p`.

`X = ones(sz1,...,szN,'like',p)` returns an `sz1`-by-...-by-`szN` array of ones like `p`.

`X = ones(sz,'like',p)` returns an array of ones like `p`. The size vector, `sz`, defines `size(X)`.

Examples

2-D Array of Ones With Fixed-Point Attributes

Create a 2-by-3 array of ones with specified numeric type and `fimath` properties.

Create a signed `fi` object with word length of 24 and fraction length of 12.

```
p = fi([],1,24,12);
```

Create a 2-by-3- array of ones that has the same numeric type properties as `p`.

```
X = ones(2,3,'like',p)
```

```
X=2x3 object
```

```
  1   1   1
  1   1   1
```

```
      DataTypeMode: Fixed-point: binary point scaling
      Signedness: Signed
      WordLength: 24
      FractionLength: 12
```

Size Defined by Existing Array

Define a 3-by-2 array `A`.

```
A = [1 4 ; 2 5 ; 3 6];
```

```
sz = size(A)
```

```
sz = 1×2
```

```
3 2
```

Create a signed `fi` object with word length of 24 and fraction length of 12.

```
p = fi([],1,24,12);
```

Create an array of ones that is the same size as `A` and has the same numeric type properties as `p`.

```
X = ones(sz, 'like', p)
```

```
X=3×2 object
```

```
1 1
1 1
1 1
```

```
DataTypeMode: Fixed-point: binary point scaling
Signedness: Signed
WordLength: 24
FractionLength: 12
```

Square Array of Ones With Fixed-Point Attributes

Create a 4-by-4 array of ones with specified numeric type and `fimath` properties.

Create a signed `fi` object with word length of 24 and fraction length of 12.

```
p = fi([],1,24,12);
```

Create a 4-by-4 array of ones that has the same numeric type properties as `p`.

```
X = ones(4, 'like', p)
```

```
X=4×4 object
```

```
1 1 1 1
1 1 1 1
1 1 1 1
1 1 1 1
```

```
DataTypeMode: Fixed-point: binary point scaling
Signedness: Signed
WordLength: 24
FractionLength: 12
```

Create Array of Ones with Attached fimath

Create a signed `fi` object with word length of 16, fraction length of 15 and `OverflowAction` set to `Wrap`.

```
format long
p = fi([],1,16,15,'OverflowAction','Wrap');
```

Create a 2-by-2 array of ones with the same `numericType` properties as `p`.

```
X = ones(2,'like',p)
```

```
X=2x2 object
    0.999969482421875    0.999969482421875
    0.999969482421875    0.999969482421875

    DataTypeMode: Fixed-point: binary point scaling
    Signedness: Signed
    WordLength: 16
    FractionLength: 15

    RoundingMethod: Nearest
    OverflowAction: Wrap
    ProductMode: FullPrecision
    SumMode: FullPrecision
```

1 cannot be represented by the data type of `p`, so the value saturates. The output `fi` object `X` has the same `numericType` and `fimath` properties as `p`.

Complex Fixed-Point One

Create a scalar fixed-point 1 that is not real valued, but instead is complex like an existing array.

Define a complex `fi` object.

```
p = fi( [1+2i 3i],1,24,12);
```

Create a scalar 1 that is complex like `p`.

```
X = ones('like',p)
```

```
X =
    1.0000 + 0.0000i

    DataTypeMode: Fixed-point: binary point scaling
    Signedness: Signed
    WordLength: 24
    FractionLength: 12
```

Write MATLAB Code That Is Independent of Data Types

Write a MATLAB algorithm that you can run with different data types without changing the algorithm itself. To reuse the algorithm, define the data types separately from the algorithm.

This approach allows you to define a baseline by running the algorithm with floating-point data types. You can then test the algorithm with different fixed-point data types and compare the fixed-point behavior to the baseline without making any modifications to the original MATLAB code.

Write a MATLAB function, `my_filter`, that takes an input parameter, `T`, which is a structure that defines the data types of the coefficients and the input and output data.

```
function [y,z] = my_filter(b,a,x,z,T)
    % Cast the coefficients to the coefficient type
    b = cast(b, 'like', T.coeffs);
    a = cast(a, 'like', T.coeffs);
    % Create the output using zeros with the data type
    y = zeros(size(x), 'like', T.data);
    for i = 1:length(x)
        y(i) = b(1)*x(i) + z(1);
        z(1) = b(2)*x(i) + z(2) - a(2) * y(i);
        z(2) = b(3)*x(i)          - a(3) * y(i);
    end
end
```

Write a MATLAB function, `zeros_ones_cast_example`, that calls `my_filter` with a floating-point step input and a fixed-point step input, and then compares the results.

```
function zeros_ones_cast_example

    % Define coefficients for a filter with specification
    % [b,a] = butter(2,0.25)
    b = [0.097631072937818    0.195262145875635    0.097631072937818];
    a = [1.00000000000000000    -0.942809041582063    0.333333333333333];

    % Define floating-point types
    T_float.coeffs = double([]);
    T_float.data   = double([]);

    % Create a step input using ones with the
    % floating-point data type
    t = 0:20;
    x_float = ones(size(t), 'like', T_float.data);

    % Initialize the states using zeros with the
    % floating-point data type
    z_float = zeros(1,2, 'like', T_float.data);

    % Run the floating-point algorithm
    y_float = my_filter(b,a,x_float,z_float,T_float);

    % Define fixed-point types
    T_fixed.coeffs = fi([],true,8,6);
    T_fixed.data   = fi([],true,8,6);

    % Create a step input using ones with the
    % fixed-point data type
    x_fixed = ones(size(t), 'like', T_fixed.data);
```

```

% Initialize the states using zeros with the
% fixed-point data type
z_fixed = zeros(1,2,'like',T_fixed.data);

% Run the fixed-point algorithm
y_fixed = my_filter(b,a,x_fixed,z_fixed,T_fixed);

% Compare the results
coder.extrinsic('clf','subplot','plot','legend')
clf
subplot(211)
plot(t,y_float,'co-',t,y_fixed,'kx-')
legend('Floating-point output','Fixed-point output')
title('Step response')
subplot(212)
plot(t,y_float - double(y_fixed),'rs-')
legend('Error')
figure(gcf)
end

```

Input Arguments

n — Size of square matrix

integer value

Size of square matrix, specified as an integer value, defines the output as a square, n-by-n matrix of ones.

- If n is zero, X is an empty matrix.
- If n is negative, it is treated as zero.

Data Types: double | single | int8 | int16 | int32 | int64 | uint8 | uint16 | uint32 | uint64

sz1, ..., szN — Size of each dimension

two or more integer values

Size of each dimension, specified as two or more integer values, defines X as a sz1-by...-by-szN array.

- If the size of any dimension is zero, X is an empty array.
- If the size of any dimension is negative, it is treated as zero.
- If any trailing dimensions greater than two have a size of one, the output, X, does not include those dimensions.

Data Types: double | single | int8 | int16 | int32 | int64 | uint8 | uint16 | uint32 | uint64

sz — Output size

row vector of integer values

Output size, specified as a row vector of integer values. Each element of this vector indicates the size of the corresponding dimension.

- If the size of any dimension is zero, X is an empty array.
- If the size of any dimension is negative, it is treated as zero.

- If any trailing dimensions greater than two have a size of one, the output, X , does not include those dimensions.

Example: `sz = [2,3,4]` defines X as a 2-by-3-by-4 array.

Data Types: `double` | `single` | `int8` | `int16` | `int32` | `int64` | `uint8` | `uint16` | `uint32` | `uint64`

p – Prototype

`fi` object | numeric variable

Prototype, specified as a `fi` object or numeric variable. To use the prototype to specify a complex object, you must specify a value for the prototype. Otherwise, you do not need to specify a value.

If the value 1 overflows the numeric type of `p`, the output saturates regardless of the specified `OverflowAction` property of the attached `fimath`. All subsequent operations performed on the output obey the rules of the attached `fimath`.

Complex Number Support: Yes

Tips

Using the `b = cast(a, 'like', p)` syntax to specify data types separately from algorithm code allows you to:

- Reuse your algorithm code with different data types.
- Keep your algorithm uncluttered with data type specifications and switch statements for different data types.
- Improve readability of your algorithm code.
- Switch between fixed-point and floating-point data types to compare baselines.
- Switch between variations of fixed-point settings without changing the algorithm code.

See Also

`cast` | `ones` | `zeros`

Topics

“Implement FIR Filter Algorithm for Floating-Point and Fixed-Point Types using `cast` and `zeros`”

“Manual Fixed-Point Conversion Workflow”

“Manual Fixed-Point Conversion Best Practices”

Introduced in R2013a

plus

Matrix sum of `fi` objects

Syntax

`plus(a,b)`

Description

`plus(a,b)` is called for the syntax `a + b` when `a` or `b` is an object.

`a + b` adds matrices `a` and `b`. `a` and `b` must have the same dimensions unless one is a scalar value (a 1-by-1 matrix). A scalar value can be added to any other value.

`plus` does not support `fi` objects of data type `Boolean`.

Note For information about the `fimath` properties involved in Fixed-Point Designer calculations, see “`fimath` Properties Usage for Fixed-Point Arithmetic” and “`fimath` ProductMode and SumMode”.

For information about calculations using Fixed-Point Designer software, see the Fixed-Point Designer documentation.

Extended Capabilities

C/C++ Code Generation

Generate C and C++ code using MATLAB® Coder™.

Usage notes and limitations:

- Any non-`fi` inputs must be constant; that is, its value must be known at compile time so that it can be cast to a `fi` object.

HDL Code Generation

Generate Verilog and VHDL code for FPGA and ASIC designs using HDL Coder™.

Inputs cannot be of data type `logical`.

See Also

`minus` | `mtimes` | `times` | `uminus`

Introduced before R2006a

pow10

Base 10 power and scale half-precision numbers

Syntax

```
Y = pow10(X)
```

Description

`Y = pow10(X)` returns an array, `Y`, whose elements are 10 raised to the power `X`.

Note This function supports only half-precision inputs.

Examples

Base 10 Power

Create a half-precision vector, `X`.

```
X = half([1;2;3;4])
```

```
X =
```

```
4x1 half column vector
```

```
1
2
3
4
```

Compute an array, `Y`, whose elements are 10 raised to the power `X`.

```
Y = pow10(X)
```

```
Y =
```

```
4x1 half column vector
```

```
10
100
1000
10000
```

Input Arguments

X — Power

scalar | vector | matrix | multidimensional array

Power, specified as a half-precision numeric scalar, vector, matrix, or multidimensional array

Data Types: Half

Output Arguments

Y – Output array

scalar | vector | matrix | multidimensional array

Array whose elements are 10 raised to the power X, returned as a half-precision scalar, vector, matrix, or multidimensional array.

See Also

half

Introduced in R2018b

pow2

Efficient fixed-point multiplication by 2^K

Syntax

```
b = pow2(a,K)
```

Description

`b = pow2(a,K)` returns the value of `a` shifted by `K` bits where `K` is an integer and `a` and `b` are `fi` objects. The output `b` always has the same word length and fraction length as the input `a`.

Note In fixed-point arithmetic, shifting by `K` bits is equivalent to, and more efficient than, computing `b = a*2^K`.

If `K` is a non-integer, the `pow2` function will round it to `floor` before performing the calculation.

The scaling of `a` must be equivalent to binary point-only scaling; in other words, it must have a power of 2 slope and a bias of 0.

`a` can be real or complex. If `a` is complex, `pow2` operates on both the real and complex portions of `a`.

The `pow2` function obeys the `OverflowAction` and `RoundingMethod` properties associated with `a`. If obeying the `RoundingMethod` property associated with `a` is not important, try using the `bitshift` function.

The `pow2` function does not support `fi` objects of data type `Boolean`.

The function also does not support the syntax `b = pow2(a)` when `a` is a `fi` object.

Examples

Example 4.1. Example 1

In the following example, `a` is a real-valued `fi` object, and `K` is a positive integer.

The `pow2` function shifts the bits of `a` 3 places to the left, effectively multiplying `a` by 2^3 .

```
a = fi(pi,1,16,8)
b = pow2(a,3)
binary_a = bin(a)
binary_b = bin(b)
```

```
a =
```

```
3.140625
```

```
DataTypeMode: Fixed-point: binary point scaling
Signedness: Signed
WordLength: 16
```

```
        FractionLength: 8

b =

        25.125

        DataTypeMode: Fixed-point: binary point scaling
        Signedness: Signed
        WordLength: 16
        FractionLength: 8

binary_a =

        '0000001100100100'

binary_b =

        '0001100100100000'
```

Example 4.2. Example 2

In the following example, *a* is a real-valued *fi* object, and *K* is a negative integer.

The *pow2* function shifts the bits of *a* 4 places to the right, effectively multiplying *a* by 2^{-4} .

```
a = fi(pi,1,16,8)
b = pow2(a,-4)
binary_a = bin(a)
binary_b = bin(b)

a =

        3.140625

        DataTypeMode: Fixed-point: binary point scaling
        Signedness: Signed
        WordLength: 16
        FractionLength: 8

b =

        0.1953125

        DataTypeMode: Fixed-point: binary point scaling
        Signedness: Signed
        WordLength: 16
        FractionLength: 8

binary_a =

        '0000001100100100'

binary_b =

        '0000000000110010'
```

Example 4.3. Example 3

The following example shows the use of `pow2` with a complex `fi` object:

```
format long g
P = fipref('NumericTypeDisplay', 'short');
a = fi(57 - 2i, 1, 16, 8)

a =

           57 -           2i
    numerictype(1,16,8)

pow2(a,2)

ans =

    127.99609375 -           8i
    numerictype(1,16,8)
```

Extended Capabilities**C/C++ Code Generation**

Generate C and C++ code using MATLAB® Coder™.

GPU Code Generation

Generate CUDA® code for NVIDIA® GPUs using GPU Coder™.

See Also

`bitshift` | `bitsll` | `bitsra` | `bitsrl`

Introduced before R2006a

power, .^

Package: embedded

Fixed-point element-wise power

Syntax

```
C = A.^B
C = power(A, B)
```

Description

$C = A.^B$ raises each element of A to the corresponding power in B .

$C = \text{power}(A, B)$ is an alternative way to compute $A.^B$.

Examples

Raise Each Element of a Matrix to a Scalar Power

Create a fixed-point matrix and raise it to a scalar power.

```
A = fi([1, 3; 4, 2])
```

```
A=2x2 object
```

```
  1   3
  4   2
```

```
      DataTypeMode: Fixed-point: binary point scaling
      Signedness: Signed
      WordLength: 16
      FractionLength: 12
```

```
C = A.^3
```

```
C=2x2 object
```

```
  1   27
 64   8
```

```
      DataTypeMode: Fixed-point: binary point scaling
      Signedness: Signed
      WordLength: 48
      FractionLength: 36
```

Input Arguments

A — Base

scalar | vector | matrix | multidimensional array

Base, specified as a scalar, vector, matrix, or multidimensional array. Inputs A and B must either be the same size or have sizes that are compatible (for example, A is an M -by- N matrix and B is a scalar or 1-by- N row vector).

Data Types: `single` | `double` | `int8` | `int16` | `int32` | `int64` | `uint8` | `uint16` | `uint32` | `uint64` | `logical` | `fi`
 Complex Number Support: Yes

B — Exponent

scalar

Exponent, specified as a non-negative, real, integer-valued scalar.

Data Types: `single` | `double` | `int8` | `int16` | `int32` | `int64` | `uint8` | `uint16` | `uint32` | `uint64` | `logical` | `fi`

Output Arguments

C — Power

scalar | vector | matrix | multidimensional array

Power, returned as an array with the same dimensions as the input A. When A has a local `fimath` object, the output C also has the same local `fimath` object. The array power operation is always performed using the default `fimath` settings.

Extended Capabilities

C/C++ Code Generation

Generate C and C++ code using MATLAB® Coder™.

Usage notes and limitations:

- When the exponent k is a variable, the `ProductMode` property of the governing `fimath` must be `SpecifyPrecision`.

HDL Code Generation

Generate Verilog and VHDL code for FPGA and ASIC designs using HDL Coder™.

Both inputs must be scalar, and the exponent input, k , must be a constant integer.

See Also

`mpower` | `power`

Introduced in R2010a

qr

Orthogonal-triangular decomposition

Description

The Fixed-Point Designer `qr` function differs from the MATLAB `qr` function as follows:

- The input `A` in `qr(A)` must be a real, signed `fi` object.
- The `qr` function ignores and discards any `fimath` attached to the input. The output is always associated with the default `fimath`.
- Pivoting is not supported for fixed-point inputs. You cannot use the following syntaxes:
 - `[~,~,E] = qr(...)`
 - `qr(A,'vector')`
 - `qr(A,B,'vector')`
- Economy size decomposition is not supported for fixed-point inputs. You cannot use the following syntax: `[Q,R] = qr(A,0)`.
- The least-squares-solution form is not supported for fixed-point inputs. You cannot use the following syntax: `qr(A,B)`.

Refer to the MATLAB `qr` reference page for more information.

Extended Capabilities

C/C++ Code Generation

Generate C and C++ code using MATLAB® Coder™.

Introduced in R2014a

quantize

Quantize fixed-point numbers

Syntax

```
y = quantize(x)
y = quantize(x,nt)
y = quantize(x,nt,rm)
y = quantize(x,nt,rm,oa)
```

```
yBP = quantize(x,s)
yBP = quantize(x,s,wl)
yBP = quantize(x,s,wl,fl)
yBP = quantize(x,s,wl,fl,rm)
yBP = quantize(x,s,wl,fl,rm,oa)
```

Description

`y = quantize(x)` quantizes `x` using these default values:

- `numericType (true,16,15)`
- Floor rounding method
- Wrap overflow action

The `numericType`, rounding method, and overflow action apply only during the quantization. The resulting value, quantized `y`, does not have any `fimath` attached to it.

`y = quantize(x,nt)` quantizes `x` to the specified `numericType` `nt`. The rounding method and overflow action use default values.

`y = quantize(x,nt,rm)` quantizes `x` to the specified `numericType`, `nt` and rounding method, `rm`. The overflow action uses the default value.

`y = quantize(x,nt,rm,oa)` quantizes `x` to the specified `numericType`, `nt`, rounding method, `rm`, and overflow action, `oa`.

`yBP = quantize(x,s)` quantizes `x` to a binary-point, scaled fixed-point number. The `s` input specifies the sign to be used in `numericType (s,16,15)`. Unspecified properties use these default values:

- `WordLength` 16
- `FractionLength` 15
- `RoundingMethod` Floor
- `OverflowAction` Wrap

`yBP = quantize(x,s,wl)` uses the specified word length, `wl`. The fraction length defaults to `wl-1`. Unspecified properties use default values.

`yBP = quantize(x,s,wl,fl)` uses the specified fraction length, `fl`. Unspecified properties use default values.

`yBP = quantize(x,s,wl,fl,rm)` uses the specified rounding method, `rm`. Unspecified properties use default values.

`yBP = quantize(x,s,wl,fl,rm,oa)` uses the specified overflow action, `oa`.

Examples

Quantize Binary-Point Scaled to Binary-Point Scaled Data

Create `numericType` object, `ntBP`, which specifies a signed, 8-bit word length, 4-bit fraction length data type.

```
ntBP = numericType(1,8,4);
```

Define the input.

```
x_BP = fi(pi)
```

```
x_BP =
    3.1416
```

```

        DataTypeMode: Fixed-point: binary point scaling
        Signedness: Signed
        WordLength: 16
        FractionLength: 13
```

Use the defined `numericType`, `ntBP`, to quantize the input, `x_BP`, to a binary-point scaled data type.

```
yBP1 = quantize(x_BP,ntBP)
```

```
yBP1 =
    3.1250
```

```

        DataTypeMode: Fixed-point: binary point scaling
        Signedness: Signed
        WordLength: 8
        FractionLength: 4
```

Quantize Binary-Point Scaled to Slope-Bias Data

Create a `numericType` object, `ntSB`, which specifies a slope-bias data type.

```
ntSB = numericType('Scaling','SlopeBias', ...
    'SlopeAdjustmentFactor',1.8,'Bias',...
    1,'FixedExponent',-12);
```

Define the input.

```
x_BP = fi(pi)
```

```
x_BP =
    3.1416
```

```

        DataTypeMode: Fixed-point: binary point scaling
        Signedness: Signed
        WordLength: 16
        FractionLength: 13

```

Use the defined `numericType`, `ntSB`, to quantize the input, `x_BP`, to a slope-bias data type.

```
ySB1 = quantize(x_BP, ntSB)
```

```
ySB1 =
    3.1415
```

```

        DataTypeMode: Fixed-point: slope and bias scaling
        Signedness: Signed
        WordLength: 16
        Slope: 0.000439453125
        Bias: 1

```

Quantize Slope-Bias Scaled to Binary-Point Scaled Data

Create a `numericType` object, `ntBP`, which specifies a signed, 8-bit word length, 4-bit fraction length data type.

```
ntBP = numericType(1,8,4);
```

Define the input.

```
x_SB = fi(rand(5,3),numericType('Scaling','SlopeBias','Bias',-0.125))
```

```

x_SB=5×3 object
    0.8147    0.0975    0.1576
    0.8750    0.2785    0.8750
    0.1270    0.5469    0.8750
    0.8750    0.8750    0.4854
    0.6324    0.8750    0.8003

```

```

        DataTypeMode: Fixed-point: slope and bias scaling
        Signedness: Signed
        WordLength: 16
        Slope: 3.0517578125e-5
        Bias: -0.125

```

Use the defined `numericType`, `ntBP`, to quantize the input, `x_SB`, to a binary point scaled data type.

```
yBP2 = quantize(x_SB,ntBP,'Nearest','Saturate')
```

```

yBP2=5×3 object
    0.8125    0.1250    0.1875
    0.8750    0.2500    0.8750
    0.1250    0.5625    0.8750
    0.8750    0.8750    0.5000
    0.6250    0.8750    0.8125

```

```

        DataTypeMode: Fixed-point: binary point scaling

```

```

Signedness: Signed
WordLength: 8
FractionLength: 4

```

Quantize Slope-Bias Scaled to Slope-Bias Scaled Data

Create a `numericType` object, `ntSB`, which specifies a slope-bias data type.

```

ntSB = numericType('Scaling', 'SlopeBias', ...
    'SlopeAdjustmentFactor', 1.8, 'Bias', ...
    1, 'FixedExponent', -12);

```

Define the input.

```

x_SB = fi(rand(5,3), numericType('Scaling', 'SlopeBias', 'Bias', -0.125))

```

```

x_SB=5×3 object
    0.8147    0.0975    0.1576
    0.8750    0.2785    0.8750
    0.1270    0.5469    0.8750
    0.8750    0.8750    0.4854
    0.6324    0.8750    0.8003

```

```

DataTypeMode: Fixed-point: slope and bias scaling
Signedness: Signed
WordLength: 16
Slope: 3.0517578125e-5
Bias: -0.125

```

Use the defined `numericType`, `ntSB`, to quantize the input, `x_SB`, to a slope-bias data type.

```

ySB2 = quantize(x_SB, ntSB, 'Ceiling', 'Wrap')

```

```

ySB2=5×3 object
    0.8150    0.0978    0.1580
    0.8752    0.2789    0.8752
    0.1272    0.5469    0.8752
    0.8752    0.8752    0.4854
    0.6326    0.8752    0.8005

```

```

DataTypeMode: Fixed-point: slope and bias scaling
Signedness: Signed
WordLength: 16
Slope: 0.000439453125
Bias: 1

```

Quantize Built-in Integer to Binary-Point Scaled Data

Create a `numericType` object, `ntBP`, which specifies a signed, 8-bit word length, 4-bit fraction length data type.

```
ntBP = numerictype(1,8,4);
```

Define the input.

```
xInt = int8(-16:4:16)
```

```
xInt = 1x9 int8 row vector
```

```
-16  -12  -8   -4   0   4   8   12  16
```

Use the defined numeric type, ntBP, to quantize the input|xInt| to a binary point scaled data type.

```
yBP3 = quantize(xInt,ntBP, 'Zero')
```

```
yBP3=1x9 object
```

```
0   4  -8  -4   0   4  -8  -4   0
```

```
      DataTypeMode: Fixed-point: binary point scaling
      Signedness: Signed
      WordLength: 8
      FractionLength: 4
```

Show the range of the quantized output.

```
range(yBP3)
```

```
ans=1x2 object
```

```
-8.0000  7.9375
```

```
      DataTypeMode: Fixed-point: binary point scaling
      Signedness: Signed
      WordLength: 8
      FractionLength: 4
```

The first two and last three values are wrapped because they are outside the representable range of the output type.

Quantize Built-in Integer to Slope-Bias Data

Create a numeric type object ntSB, which specifies a slope-bias data type.

```
ntSB = numerictype('Scaling','SlopeBias', ...
    'SlopeAdjustmentFactor',1.8,'Bias',...
    1,'FixedExponent',-12);
```

Define the input.

```
xInt = int8(-16:4:16)
```

```
xInt = 1x9 int8 row vector
```

```
-16  -12  -8   -4   0   4   8   12  16
```

Use the defined `numericType`, `ntSB`, to quantize the input, `xInt`, to a slope-bias data type.

```
ySB3 = quantize(xInt,ntSB, 'Round', 'Saturate')
```

```
ySB3=1x9 object
Columns 1 through 7
-13.4000 -11.9814 -7.9877 -3.9939 -0.0002 3.9936 7.9873
Columns 8 through 9
11.9811 15.3996

        DataTypeMode: Fixed-point: slope and bias scaling
        Signedness: Signed
        WordLength: 16
        Slope: 0.000439453125
        Bias: 1
```

Show the range of the quantized output.

```
range(ySB3)
```

```
ans=1x2 object
-13.4000 15.3996

        DataTypeMode: Fixed-point: slope and bias scaling
        Signedness: Signed
        WordLength: 16
        Slope: 0.000439453125
        Bias: 1
```

The first and last values saturate because they are at the limits of the representable range of the output type.

Input Arguments

x — Input data

fi objects or built-in integers

Input data to quantize. Valid inputs are:

- Built-in signed or unsigned integers (`int8`, `int16`, `int32`, `int64`, `uint8`, `uint16`, `uint32`, `uint64`)
- Binary point scaled fixed-point fi
- Slope-bias scaled fixed-point fi

Although fi doubles and fi singles are allowed as inputs, they pass through the `quantize` function without being quantized.

nt — Numeric type

(`true`,16,15) (default)

Numeric type object that defines the sign, word length, and fraction length of a fixed-point number.

rm — Rounding method

Floor (default) | Ceiling | Convergent | Nearest | Round | Zero

Rounding method to use

oa — Overflow action

Wrap (default) | Saturate

Action to take when a data overflow occurs

s — Signedness

true (default) | false

Whether the fixed-point number is signed (true) or unsigned (false)

wl — Word length

16 (default)

Word length of the fixed-point number

fl — Fraction length

15 (default)

Fraction length of the fixed-point number

Output Arguments

y — Quantized output

fi object

Quantized value of the input

yBP — Quantized output

fi object

Input quantized to binary-point scaled value

Extended Capabilities

C/C++ Code Generation

Generate C and C++ code using MATLAB® Coder™.

See Also

fi | fimath | fixed.Quantizer | numericType

Topics

“Compute Quantization Error”

Introduced before R2006a

quantizenumeric

Quantize numeric data

Syntax

```
y = quantizenumeric(x, s, w, f, r, o)
y = quantizenumeric(x, s, w, f, r)
```

Description

`y = quantizenumeric(x, s, w, f, r, o)` quantizes the value specified in `x` based on the numeric type information specified in `s`, `w`, `f`, `r`, and `o`.

`y = quantizenumeric(x, s, w, f, r)` quantizes the value specified in `x` using the numeric type information specified in `s`, `w`, `f`, and `r`.

Examples

Quantize the Value of pi

Quantize the value of pi using a signed numeric type with a word length of 16 bits, a fraction length of 13 bits, and rounding towards positive infinity.

```
x = pi;
y = quantizenumeric(x,1,16,13,'ceil')

y = 3.1416
```

Specify a different rounding method. Observe rounding towards zero affects the quantized value.

```
x = pi;
y = quantizenumeric(x,1,16,13,'fix')

y = 3.1415
```

Input Arguments

x — Value to quantize

scalar | vector | array

The value to quantize, specified as a scalar, vector, matrix or multidimensional array.

Data Types: double

s — signedness

1 | 0

The signedness of the quantized value, specified as either 0 (unsigned) or 1 (signed).

Data Types: double

w – word length

scalar integer

The word length of the quantized value, specified as a scalar integer.

Data Types: double

f – fraction length

scalar integer

The fraction length of the quantized value, specified as a scalar integer.

Data Types: double

r – Rounding method

character vector

Rounding method to use for quantization, specified as one of the following:

- `ceil`— Round towards positive infinity (same as 'ceiling')
- `ceiling`— Round towards positive infinity (same as 'ceil')
- `convergent`— Convergent rounding
- `fix`— Round towards zero (same as 'zero')
- `floor`— Round towards negative infinity
- `nearest`— Round towards nearest with ties rounding towards positive infinity
- `round`— Round towards nearest with ties rounding up in absolute value
- `zero`— Round towards zero (same as 'fix')

Data Types: char

o – Overflow action

saturate | wrap

Overflow action to use for quantization, specified as either 'saturate' or 'wrap'. When no overflow action is specified, `quantize numeric` uses `saturate`.

Data Types: char

Output Arguments**y – quantized output value**

scalar | vector | matrix | multidimensional array

The quantized output value. `y` always has the same dimensions as `x`, and is always a double.

See Also

cast | fi | fimath | fixed.Quantizer | numericType | quantize | quantizer

Introduced in R2016a

quantize method

Apply quantizer object to data

Syntax

```
y = quantize(q, x)
[y1,y2,...] = quantize(q,x1,x2,...)
```

Description

`y = quantize(q, x)` uses the quantizer object `q` to quantize `x`. When `x` is a numeric array, each element of `x` is quantized. When `x` is a cell array, each numeric element of the cell array is quantized. When `x` is a structure, each numeric field of `x` is quantized. Quantize does not change nonnumeric elements or fields of `x`, nor does it issue warnings for nonnumeric values. The output `y` is a built-in double. When the input `x` is a structure or cell array, the fields of `y` are built-in doubles.

`[y1,y2,...] = quantize(q,x1,x2,...)` is equivalent to `y1 = quantize(q,x1)`, `y2 = quantize(q,x2)`,...

The quantizer object states

- `max` — Maximum value before quantizing
- `min` — Minimum value before quantizing
- `noverflows` — Number of overflows
- `nunderflows` — Number of underflows
- `noperations` — Number of quantization operations

are updated during the call to `quantize`, and running totals are kept until a call to `resetlog` is made.

Examples

Custom Precision Floating-Point

The following example demonstrates using `quantize` to quantize data.

```
u=linspace(-15, 15, 1000);
q=quantizer([6 3], 'float');
range(q)
```

```
ans = 1x2
     -14     14
```

```
y=quantize(q, u);
```

Warning: 68 overflow(s) occurred in the fi quantize operation.

```
plot(u, y); title(tostring(q))
```

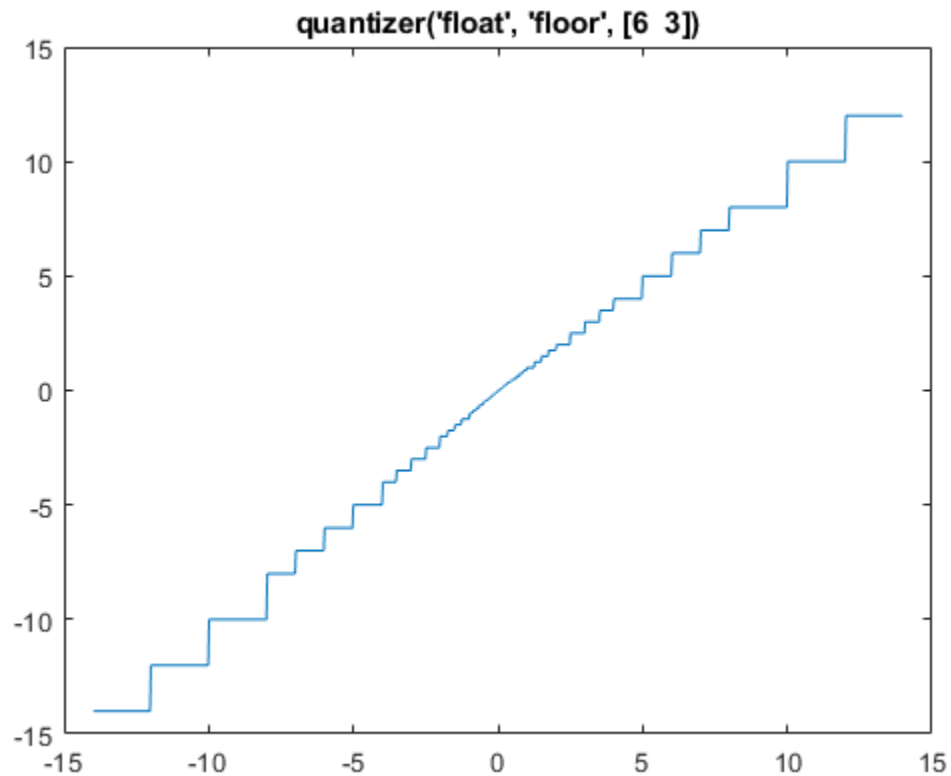

Fixed-Point

The following example demonstrates using `quantize` to quantize data.

```
u=linspace(-15, 15, 1000);
q=quantizer([6 2], 'wrap');
range(q)
```

```
ans = 1x2
```

```
    -8.0000    7.7500
```

```
y=quantize(q, u);
```

```
Warning: 468 overflow(s) occurred in the fi quantize operation.
```

```
plot(u, y); title(tostring(q))
```

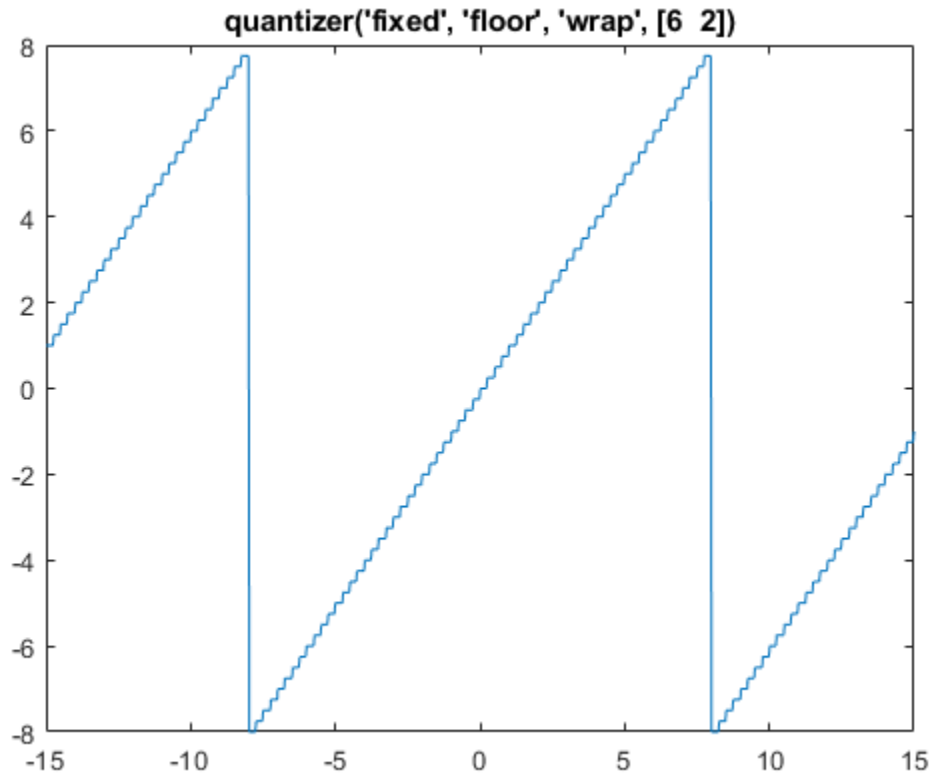

See Also

`assignmentquantizer` | `quantizer` | `set` | `unitquantize` | `unitquantizer`

Introduced in R2012b

quantizer

Construct quantizer object

Syntax

```
q = quantizer
q = quantizer('PropertyName1',PropertyValue1,...)
q = quantizer(PropertyValue1,PropertyValue2,...)
q = quantizer(struct)
q = quantizer(pn,pv)
```

Description

`q = quantizer` creates a `quantizer` object with properties set to their default values. To use this object to quantize values, use the `quantize` method.

`q = quantizer('PropertyName1',PropertyValue1,...)` uses property name/ property value pairs.

`q = quantizer(PropertyValue1,PropertyValue2,...)` creates a `quantizer` object with the listed property values. When two values conflict, `quantizer` sets the last property value in the list. Property values are unique; you can set the property names by specifying just the property values in the command.

`q = quantizer(struct)`, where `struct` is a structure whose field names are property names, sets the properties named in each field name with the values contained in the structure.

`q = quantizer(pn,pv)` sets the named properties specified in the cell array of character vectors `pn` to the corresponding values in the cell array `pv`.

The `quantizer` object property values are listed below. These properties are described in detail in “`quantizer` Object Properties” on page 3-4.

Property Name	Property Value	Description
mode	'double'	Double-precision mode. Override all other parameters.
	'float'	Custom-precision floating-point mode.
	'fixed'	Signed fixed-point mode.
	'single'	Single-precision mode. Override all other parameters.
	'ufixed'	Unsigned fixed-point mode.
roundmode	'ceil'	Round toward positive infinity.

Property Name	Property Value	Description
	'convergent'	Round to nearest integer with ties rounding to nearest even integer.
	'fix'	Round toward zero.
	'floor'	Round toward negative infinity.
	'Nearest'	Round to nearest integer with ties rounding toward positive infinity.
	'Round'	Round to nearest integer with ties rounding to nearest integer with greater absolute value.
overflowmode (fixed-point only)	'saturate'	Saturate on overflow.
	'wrap'	Wrap on overflow.
format	[wordlength fractionlength]	Format for fixed or ufixed mode.
	[wordlength exponentlength]	Format for float mode.

The default property values for a quantizer object are

```
DataMode = fixed
RoundMode = floor
OverflowMode = saturate
Format = [16 15]
```

Along with the preceding properties, quantizer objects have read-only states: `max`, `min`, `noverflows`, `nunderflows`, and `noperations`. They can be accessed through `quantizer/get` or `q.maxlog`, `q.minlog`, `q.noverflows`, `q.nunderflows`, and `q.noperations`, but they cannot be set. They are updated during the `quantizer/quantize` method, and are reset by the `resetlog` function.

The following table lists the read-only quantizer object states:

Property Name	Description
<code>max</code>	Maximum value before quantizing
<code>min</code>	Minimum value before quantizing
<code>noverflows</code>	Number of overflows
<code>nunderflows</code>	Number of underflows
<code>noperations</code>	Number of data points quantized

Examples

The following example operations are equivalent.

Setting quantizer object properties by listing property values only in the command,

```
q = quantizer('fixed', 'Ceiling', 'Saturate', [5 4])
```

Using a structure `struct` to set `quantizer` object properties,

```
struct.mode = 'fixed';  
struct.roundmode = 'ceil';  
struct.overflowmode = 'saturate';  
struct.format = [5 4];  
q = quantizer(struct);
```

Using property name and property value cell arrays `pn` and `pv` to set `quantizer` object properties,

```
pn = {'mode', 'roundmode', 'overflowmode', 'format'};  
pv = {'fixed', 'ceil', 'saturate', [5 4]};  
q = quantizer(pn, pv)
```

Using property name/property value pairs to configure a `quantizer` object,

```
q = quantizer('mode', 'fixed', 'roundmode', 'ceil', ...  
'overflowmode', 'saturate', 'format', [5 4]);
```

See Also

[assignmentquantizer](#) | [fi](#) | [fimath](#) | [fipref](#) | [numerictype](#) | [quantize](#) | [quantizenumeric](#) | [set](#) | [unitquantize](#) | [unitquantizer](#)

Introduced before R2006a

randquant

Generate uniformly distributed, quantized random number using `quantizer` object

Syntax

```
randquant(q,n)
randquant(q,m,n)
randquant(q,m,n,p,...)
randquant(q,[m,n])
randquant(q,[m,n,p,...])
```

Description

`randquant(q,n)` uses `quantizer` object `q` to generate an `n`-by-`n` matrix with random entries whose values cover the range of `q` when `q` is a fixed-point `quantizer` object. When `q` is a floating-point `quantizer` object, `randquant` populates the `n`-by-`n` array with values covering the range

-[square root of `realmax(q)`] to [square root of `realmax(q)`]

`randquant(q,m,n)` uses `quantizer` object `q` to generate an `m`-by-`n` matrix with random entries whose values cover the range of `q` when `q` is a fixed-point `quantizer` object. When `q` is a floating-point `quantizer` object, `randquant` populates the `m`-by-`n` array with values covering the range

-[square root of `realmax(q)`] to [square root of `realmax(q)`]

`randquant(q,m,n,p,...)` uses `quantizer` object `q` to generate an `m`-by-`n`-by-`p`-by ... matrix with random entries whose values cover the range of `q` when `q` is fixed-point `quantizer` object. When `q` is a floating-point `quantizer` object, `randquant` populates the matrix with values covering the range

-[square root of `realmax(q)`] to [square root of `realmax(q)`]

`randquant(q,[m,n])` uses `quantizer` object `q` to generate an `m`-by-`n` matrix with random entries whose values cover the range of `q` when `q` is a fixed-point `quantizer` object. When `q` is a floating-point `quantizer` object, `randquant` populates the `m`-by-`n` array with values covering the range

-[square root of `realmax(q)`] to [square root of `realmax(q)`]

`randquant(q,[m,n,p,...])` uses `quantizer` object `q` to generate `p` `m`-by-`n` matrices containing random entries whose values cover the range of `q` when `q` is a fixed-point `quantizer` object. When `q` is a floating-point `quantizer` object, `randquant` populates the `m`-by-`n` arrays with values covering the range

-[square root of `realmax(q)`] to [square root of `realmax(q)`]

`randquant` produces pseudorandom numbers. The number sequence `randquant` generates during each call is determined by the state of the generator. Because MATLAB resets the random number generator state at startup, the sequence of random numbers generated by the function remains the same unless you change the state.

`randquant` works like `rng` in most respects.

Examples

```
q = quantizer([4 3]);  
rng('default')  
randquant(q,3)
```

```
ans =
```

```
    0.5    0.625   -0.5  
    0.625   0.125    0  
   -0.875  -0.875   0.75
```

See Also

[quantizer](#) | [rand](#) | [range](#) | [realmax](#)

Introduced before R2006a

range

Numerical range of `fi` or quantizer object

Syntax

```
range(a)
[min_val, max_val] = range(a)
r = range(q)
[min_val, max_val] = range(q)
```

Description

`range(a)` returns a `fi` object with the minimum and maximum possible values of `fi` object `a`. All possible quantized real-world values of `a` are in the range returned. If `a` is a complex number, then all possible values of `real(a)` and `imag(a)` are in the range returned.

`[min_val, max_val] = range(a)` returns the minimum and maximum values of `fi` object `a` in separate output variables.

`r = range(q)` returns the two-element row vector $r = [a \ b]$ such that for all real x , $y = \text{quantize}(q, x)$ returns y in the range $a \leq y \leq b$.

`[min_val, max_val] = range(q)` returns the minimum and maximum values of the range in separate output variables.

Examples

```
q = quantizer('float',[6 3]);
r = range(q)

r =
    -14     14

q = quantizer('fixed',[4 2],'floor');
[min_val,max_val] = range(q)

min_val =
    -2

max_val =
    1.75
```

Algorithms

If `q` is a floating-point quantizer object, $a = -\text{realmax}(q)$, $b = \text{realmax}(q)$.

If `q` is a signed fixed-point quantizer object (`datamode = 'fixed'`),

$$a = -\text{realmax}(q) - \text{eps}(q) = \frac{-2^{w-1}}{2^f}$$

$$b = \text{realmax}(q) = \frac{2^{w-1} - 1}{2^f}$$

If `q` is an unsigned fixed-point quantizer object (`datamode = 'ufixed'`),

$$a = 0$$

$$b = \text{realmax}(q) = \frac{2^w - 1}{2^f}$$

See `realmax` for more information.

Extended Capabilities

C/C++ Code Generation

Generate C and C++ code using MATLAB® Coder™.

HDL Code Generation

Generate Verilog and VHDL code for FPGA and ASIC designs using HDL Coder™.

See Also

`eps` | `exponentmax` | `exponentmin` | `fractionlength` | `intmax` | `intmin` | `lowerbound` | `lsb` | `max` | `min` | `realmax` | `realmin` | `upperbound`

Introduced before R2006a

rdivide, ./

Package: embedded

Right-array division

Syntax

```
X = A./B
X = rdivide(A,B)
```

Description

$X = A./B$ performs right-array division by dividing each element of A by the corresponding element of B .

$X = \text{rdivide}(A,B)$ is an alternative way to execute $X = A./B$.

Examples

Perform Right-Array Division of Two Matrices

This example shows how perform right-array division on a 3-by-3 magic square of `fi` objects. Each element of the 3-by-3 magic square is divided by the corresponding element in the 3-by-3 input array `b`.

The `rdivide` function outputs a 3-by-3 array of signed `fi` objects, each of which has a word length of 16 bits and fraction length of 11 bits.

```
a = fi(magic(3))
```

```
a=3x3 object
```

```
 8   1   6
 3   5   7
 4   9   2
```

```
      DataTypeMode: Fixed-point: binary point scaling
      Signedness: Signed
      WordLength: 16
      FractionLength: 11
```

```
b = int8([3 3 4; 1 2 4 ; 3 1 2 ])
```

```
b = 3x3 int8 matrix
```

```
 3   3   4
 1   2   4
 3   1   2
```

```
c = a./b
```

```

c=3x3 object
  2.6665    0.3335    1.5000
  3.0000    2.5000    1.7500
  1.3335    9.0000    1.0000

  DataTypeMode: Fixed-point: binary point scaling
  Signedness: Signed
  WordLength: 16
  FractionLength: 11

```

Input Arguments

A — Numerator

scalar | vector | matrix | multidimensional array

Numerator, specified as a scalar, vector, matrix, or multidimensional array. If inputs A and B are not the same size, one of them must be a scalar value.

If A is complex, the real and imaginary parts of A are independently divided by B.

Data Types: single | double | int8 | int16 | int32 | int64 | uint8 | uint16 | uint32 | uint64 | logical | fi

Complex Number Support: Yes

B — Denominator

scalar | vector | matrix | multidimensional array

Denominator, specified as a scalar, vector, matrix, or multidimensional array. If inputs A and B are not the same size, one of them must be a scalar value.

Data Types: single | double | int8 | int16 | int32 | int64 | uint8 | uint16 | uint32 | uint64 | logical | fi

Output Arguments

X — Quotient

scalar | vector | matrix | multidimensional array

Quotient, returned as a scalar, vector, matrix, or multidimensional array.

The following table shows the rules used to assign property values to the output of the `rdivide` function.

Output Property	Rule
Signedness	If either input is Signed, then the output is Signed. If both inputs are Unsigned, then the output is Unsigned.
WordLength	The output word length equals the maximum of the input word lengths.
FractionLength	For $c = a./b$, the fraction length of output c equals the fraction length of a minus the fraction length of b.

Algorithms

The following table shows the rules the `rdivide` function uses to handle inputs with different data types.

Case	Rule
Interoperation of <code>fi</code> objects and built-in integers	Built-in integers are treated as fixed-point objects. For example, <code>B = int8(2)</code> is treated as an <code>s8,0</code> <code>fi</code> object.
Interoperation of <code>fi</code> objects and constants	MATLAB for code generation treats constant integers as fixed-point objects with the same word length as the <code>fi</code> object and a fraction length of 0.
Interoperation of mixed data types	Similar to all other <code>fi</code> object functions, when inputs <code>a</code> and <code>b</code> have different data types, the data type with the higher precedence determines the output data type. The order of precedence is as follows: <ol style="list-style-type: none"> 1 ScaledDouble 2 Fixed-point 3 Built-in double 4 Built-in single When both inputs are <code>fi</code> objects, the only data types that are allowed to mix are <code>ScaledDouble</code> and <code>Fixed-point</code> .

Extended Capabilities

C/C++ Code Generation

Generate C and C++ code using MATLAB® Coder™.

See Also

`add` | `divide` | `fi` | `fimath` | `mrdivide` | `numericType` | `sub` | `sum`

Introduced in R2009a

realmax

Largest positive fixed-point value or quantized number

Syntax

```
realmax(a)
realmax(q)
```

Description

`realmax(a)` is the largest real-world value that can be represented in the data type of `fi` object `a`. Anything larger overflows.

`realmax(q)` is the largest quantized number that can be represented where `q` is a quantizer object. Anything larger overflows.

Examples

```
q = quantizer('float',[6 3]);
x = realmax(q)
```

```
x =
```

```
14
```

Algorithms

If `q` is a floating-point quantizer object, the largest positive number, `x`, is

$$x = 2^{E_{max}} \cdot (2 - eps(q))$$

If `q` is a signed fixed-point quantizer object, the largest positive number, `x`, is

$$x = \frac{2^w - 1}{2^f}$$

If `q` is an unsigned fixed-point quantizer object (`datamode = 'ufixed'`), the largest positive number, `x`, is

$$x = \frac{2^w - 1}{2^f}$$

Extended Capabilities

C/C++ Code Generation

Generate C and C++ code using MATLAB® Coder™.

HDL Code Generation

Generate Verilog and VHDL code for FPGA and ASIC designs using HDL Coder™.

See Also

eps | exponentmax | exponentmin | fractionlength | intmax | intmin | lowerbound | lsb |
quantizer | range | realmin | upperbound

Introduced before R2006a

realmin

Smallest positive normalized fixed-point value or quantized number

Syntax

```
x=realmin(a)
x=realmin(q)
```

Description

`x=realmin(a)` is the smallest positive real-world value that can be represented in the data type of `fi` object `a`. Anything smaller than `x` underflows or is an IEEE “denormal” number.

`x=realmin(q)` is the smallest positive normal quantized number where `q` is a quantizer object. Anything smaller than `x` underflows or is an IEEE “denormal” number.

Examples

```
q = quantizer('float',[6 3]);
x = realmin(q)

x =
```

```
0.25
```

Algorithms

If `q` is a floating-point quantizer object, $x = 2^{E_{min}}$ where $E_{min} = \text{exponentmin}(q)$ is the minimum exponent.

If `q` is a signed or unsigned fixed-point quantizer object, $x = 2^{-f} = \varepsilon$ where f is the fraction length.

Extended Capabilities

C/C++ Code Generation

Generate C and C++ code using MATLAB® Coder™.

HDL Code Generation

Generate Verilog and VHDL code for FPGA and ASIC designs using HDL Coder™.

See Also

`eps` | `exponentmax` | `exponentmin` | `fractionlength` | `intmax` | `intmin` | `lowerbound` | `lsb` | `range` | `realmax` | `upperbound`

Introduced before R2006a

reinterprecast

Convert fixed-point data types without changing underlying data

Syntax

```
c = reinterprecast(a, T)
```

Description

`c = reinterprecast(a, T)` converts the input `a` to the data type specified by `numericType` object `T` without changing the underlying data. The result is returned in `fi` object `c`.

The input `a` must be a built-in integer or a `fi` object with a fixed-point data type. `T` must be a `numericType` object with a fully specified fixed-point data type. The word length of inputs `a` and `T` must be the same.

The `reinterprecast` function differs from the MATLAB `typecast` and `cast` functions in that it only operates on `fi` objects and built-in integers, and it does not allow the word length of the input to change.

Examples

In the following example, `a` is a signed `fi` object with a word length of 8 bits and a fraction length of 7 bits. The `reinterprecast` function converts `a` into an unsigned `fi` object `c` with a word length of 8 bits and a fraction length of 0 bits. The real-world values of `a` and `c` are different, but their binary representations are the same.

```
a = fi([-1 pi/4],1,8,7)
T = numericType(0,8,0);
c = reinterprecast(a,T)
```

`a =`

```
          -1          0.7890625
numericType(1,8,7)
```

`c =`

```
128  101
numericType(0,8,0)
```

To verify that the underlying data has not changed, compare the binary representations of `a` and `c`:

```
binary_a = bin(a)
binary_c = bin(c)
```

`binary_a =`

```
'10000000  01100101'
```

`binary_c =`

```
'10000000 01100101'
```

Extended Capabilities

C/C++ Code Generation

Generate C and C++ code using MATLAB® Coder™.

HDL Code Generation

Generate Verilog and VHDL code for FPGA and ASIC designs using HDL Coder™.

See Also

`cast` | `fi` | `numerictype` | `typecast`

Introduced in R2008b

removefimath

Remove fimath object from fi object

Syntax

```
y = removefimath(x)
```

Description

`y = removefimath(x)` returns a fi object `y` with `x`'s `numericType` and value, and no `fimath` object attached. You can use this function as `y = removefimath(y)`, which gives you localized control over the `fimath` settings. This function also is useful for preventing errors about `embedded.fimath` of both operands needing to be equal.

Examples

Remove fimath Object from fi Object

This example shows how to define a fi object, define a fimath object, attach the fimath object to the fi object and then, remove the attached fimath object.

```
a = fi(pi)
a =
    3.1416

        DataTypeMode: Fixed-point: binary point scaling
        Signedness: Signed
        WordLength: 16
        FractionLength: 13

f = fimath('RoundingMethod','Floor','OverflowAction','Wrap');
a = setfimath(a,f)

a =
    3.1416

        DataTypeMode: Fixed-point: binary point scaling
        Signedness: Signed
        WordLength: 16
        FractionLength: 13

        RoundingMethod: Floor
        OverflowAction: Wrap
        ProductMode: FullPrecision
        SumMode: FullPrecision

b = removefimath(a)

b =
    3.1416
```

```

    DataTypeMode: Fixed-point: binary point scaling
    Signedness: Signed
    WordLength: 16
    FractionLength: 13

```

Set and Remove fimath for Code Generation

Use the pattern `x = setfimath(x,f)` and `y = removefimath(y)` to insulate variables from `fimath` settings outside the function. This pattern does not create copies of the data in generated code.

```

function y = fixed_point_32bit_KeepLSB_plus_example(a,b)
    f = fimath('OverflowAction','Wrap',...
        'RoundingMethod','Floor',...
        'SumMode','KeepLSB',...
        'SumWordLength',32);
    a = setfimath(a,f);
    b = setfimath(b,f);
    y = a + b;
    y = removefimath(y);
end

```

If you have the MATLAB Coder product, you can generate C code. This example generates C code on a computer with 32-bit, native integer type.

```

a = fi(0,1,16,15);
b = fi(0,1,16,15);
codegen -config:lib fixed_point_32bit_KeepLSB_plus_example...
        -args {a,b} -launchreport

```

```

int fixed_point_32bit_KeepLSB_plus_example(short a, short b)
{
    return a + b;
}

```

Input Arguments

x — Input data

fi object | built-in integer | double | single

Input data, specified as a `fi` object or built-in integer, from which to copy the data type and value to the output. `x` must be a `fi` object or an integer data type (`int8`, `int16`, `int32`, `int64`, `uint8`, `uint16`, `uint32`, or `uint64`). If `x` is not a `fi` object or integer data type, then `y = x`.

Output Arguments

y — Output fi object

fi object | built-in integer | double | single

Output `fi` object, returned as a `fi` object with no `fimath` object attached. The data type and value of the output match the input. If the input, `x`, is not a `fi` object `y = x`.

Extended Capabilities

C/C++ Code Generation

Generate C and C++ code using MATLAB® Coder™.

See Also

`fi` | `fimath` | `setfimath`

Introduced in R2012b

rescale

Change scaling of `fi` object

Syntax

```
b = rescale(a, fractionlength)
b = rescale(a, slope, bias)
b = rescale(a, slopeadjustmentfactor, fixedexponent, bias)
b = rescale(a, ..., PropertyName, PropertyValue, ...)
```

Description

The `rescale` function acts similarly to the `fi copy` function with the following exceptions:

- The `fi copy` constructor preserves the real-world value, while `rescale` preserves the stored integer value.
- `rescale` does not allow the `Signed` and `WordLength` properties to be changed.

Examples

In the following example, `fi` object `a` is rescaled to create `fi` object `b`. The real-world values of `a` and `b` are different, while their stored integer values are the same:

```
p = fipref('FimathDisplay','none',...
          'NumericTypeDisplay','short');
a = fi(10, 1, 8, 3)

a =

    10
    numerictype(1,8,3)

b = rescale(a,1)

b =

    40
    numerictype(1,8,1)

stored_integer_a = storedInteger(a);
stored_integer_b = storedInteger(b);
isequal(stored_integer_a,stored_integer_b)

ans =

    logical

    1
```

Extended Capabilities

C/C++ Code Generation

Generate C and C++ code using MATLAB® Coder™.

HDL Code Generation

Generate Verilog and VHDL code for FPGA and ASIC designs using HDL Coder™.

See Also

fi

Introduced before R2006a

reset

Reset objects to initial conditions

Syntax

```
reset(P)  
reset(q)
```

Description

reset(P) resets the `fipref` object P to its initial conditions.

reset(q) resets the following `quantizer` object properties to their initial conditions:

- `minlog`
- `maxlog`
- `noverflows`
- `nunderflows`
- `noperations`

See Also

resetlog

Introduced before R2006a

resetglobalfimath

Set global fimath to MATLAB factory default

Syntax

```
resetglobalfimath
```

Description

`resetglobalfimath` sets the global fimath to the MATLAB factory default in your current MATLAB session. The MATLAB factory default has the following properties:

```
RoundingMethod: Nearest
OverflowAction: Saturate
ProductMode: FullPrecision
SumMode: FullPrecision
```

Examples

In this example, you create your own `fimath` object `F` and set it as the global fimath. Then, using the `resetglobalfimath` command, reset the global fimath to the MATLAB factory default setting.

```
F = fimath('RoundingMethod','Floor','OverflowAction','Wrap');
globalfimath(F);
F1 = fimath
a = fi(pi)
```

F1 =

```
RoundingMethod: Floor
OverflowAction: Wrap
ProductMode: FullPrecision
SumMode: FullPrecision
```

a =

3.1416

```
DataTypeMode: Fixed-point: binary point scaling
Signedness: Signed
WordLength: 16
FractionLength: 13
```

Now, set the global fimath back to the factory default setting using `resetglobalfimath`:

```
resetglobalfimath;
F2 = fimath
a = fi(pi)
```

F2 =

```
RoundingMethod: Nearest
OverflowAction: Saturate
ProductMode: FullPrecision
SumMode: FullPrecision
a =
3.1416
DataTypeMode: Fixed-point: binary point scaling
Signedness: Signed
WordLength: 16
FractionLength: 13
```

You've now set the global fimath in your current MATLAB session back to the factory default setting. To use the factory default setting of the global fimath in future MATLAB sessions, you must use the `removeglobalfimathpref` command.

Alternatives

`reset(G)` — If G is a handle to the global fimath, `reset(G)` is equivalent to using the `resetglobalfimath` command.

See Also

`fimath` | `globalfimath` | `removeglobalfimathpref`

Introduced in R2010a

removeglobalfimathpref

Remove global fimath preference

Syntax

```
removeglobalfimathpref
```

Description

`removeglobalfimathpref` removes your global fimath from the MATLAB preferences. Once you remove the global fimath from your preferences, you cannot save it to them again. It is best practice to remove global fimath from the MATLAB preferences so that you start each MATLAB session using the default fimath settings.

The `removeglobalfimathpref` function does not change the global fimath for your current MATLAB session. To revert back to the factory default setting of the global fimath in your current MATLAB session, use the `resetglobalfimath` command.

Examples

Example 4.4. Removing Your Global fimath from the MATLAB Preferences

Typing

```
removeglobalfimathpref;
```

at the MATLAB command line removes your global fimath from the MATLAB preferences. Using the `removeglobalfimathpref` function allows you to:

- Continue using your global fimath in the current MATLAB session
- Use the MATLAB factory default setting of the global fimath in all future MATLAB sessions

To revert back to the MATLAB factory default setting of the global fimath in both your current and future MATLAB sessions, use both the `resetglobalfimath` and the `removeglobalfimathpref` commands:

```
resetglobalfimath;  
removeglobalfimath;
```

See Also

`fimath` | `globalfimath` | `resetglobalfimath`

Introduced in R2010a

resetlog

Clear log for `fi` or quantizer object

Syntax

```
resetlog(a)  
resetlog(q)
```

Description

`resetlog(a)` clears the log for `fi` object `a`.

`resetlog(q)` clears the log for quantizer object `q`.

Turn logging on or off by setting the `fipref` property `LoggingMode`.

See Also

`fipref` | `maxlog` | `minlog` | `noperations` | `noverflows` | `nunderflows` | `reset`

Introduced before R2006a

round

Round `fi` object toward nearest integer or round input data using `quantizer` object

Syntax

```
y = round(a)
y = round(q,x)
```

Description

`y = round(a)` rounds `fi` object `a` to the nearest integer. In the case of a tie, `round` rounds values to the nearest integer with greater absolute value. The rounded value is returned in `fi` object `y`.

`y = round(q,x)` uses the `RoundingMethod` and `FractionLength` settings of `quantizer` object `q` to round the numeric data `x`, but does not check for overflows during the operation. Input `x` must be a built-in numeric variable. Use the `cast` function to work with `fi` objects.

Examples

Use round on a Signed `fi` Object

The following example demonstrates how the `round` function affects the `numericType` properties of a signed `fi` object with a word length of 8 and a fraction length of 3.

```
a = fi(pi,1,8,3)
a =
    3.1250

    DataTypeMode: Fixed-point: binary point scaling
    Signedness: Signed
    WordLength: 8
    FractionLength: 3

y = round(a)
y =
    3

    DataTypeMode: Fixed-point: binary point scaling
    Signedness: Signed
    WordLength: 6
    FractionLength: 0
```

The following example demonstrates how the `round` function affects the `numericType` properties of a signed `fi` object with a word length of 8 and a fraction length of 12.

```
a = fi(0.025,1,8,12)
a =
    0.0249
```

```
        DataTypeMode: Fixed-point: binary point scaling
        Signedness: Signed
        WordLength: 8
        FractionLength: 12

y = round(a)

y =
     0

        DataTypeMode: Fixed-point: binary point scaling
        Signedness: Signed
        WordLength: 2
        FractionLength: 0
```

Use quantizer Object to Round Numeric Data

This example shows how to use the rounding method and fraction length specified by quantizer object `q` to round the numeric data in `x`.

```
q = quantizer('fixed','convergent','wrap',[3 2])
```

```
q =
```

```
        DataMode = fixed
        RoundMode = convergent
        OverflowMode = wrap
        Format = [3 2]
```

```
x = (-2:eps(q)/4:2)';
y = round(q,x);
plot(x,[x,y],'.-'); axis square
```

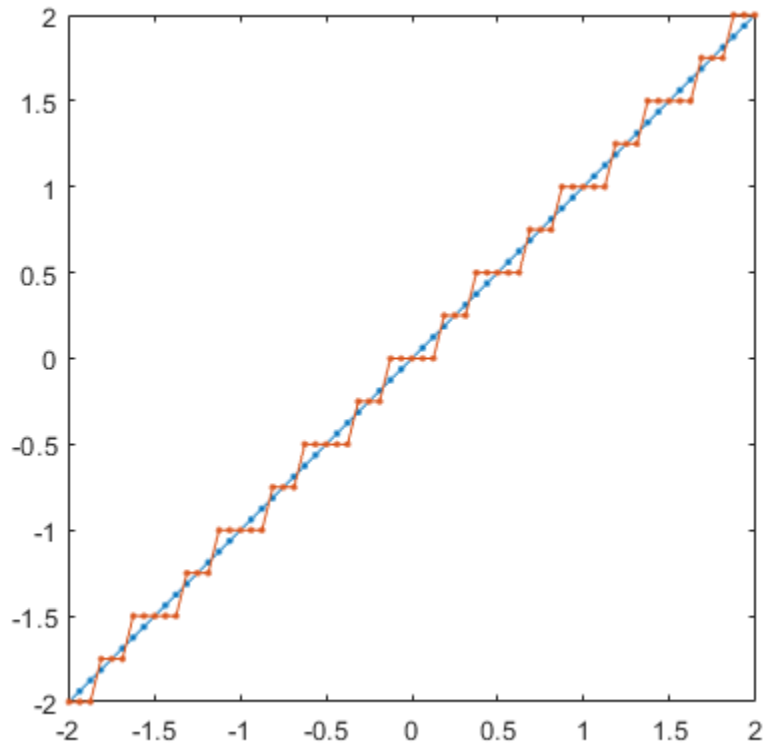

Compare Rounding Methods

The functions `convergent`, `nearest`, and `round` differ in the way they treat values whose least significant digit is 5.

- The `convergent` function rounds ties to the nearest even integer.
- The `nearest` function rounds ties to the nearest integer toward positive infinity.
- The `round` function rounds ties to the nearest integer with greater absolute value.

This example illustrates these differences for a given input, `a`.

```
a = fi([-3.5:3.5]');
y = [a convergent(a) nearest(a) round(a)]
```

```
y=8x4 object
-3.5000  -4.0000  -3.0000  -4.0000
-2.5000  -2.0000  -2.0000  -3.0000
-1.5000  -2.0000  -1.0000  -2.0000
-0.5000   0       0       -1.0000
 0.5000   0       1.0000  1.0000
 1.5000   2.0000  2.0000  2.0000
 2.5000   2.0000  3.0000  3.0000
 3.5000   3.9999  3.9999  3.9999
```



```

    DataTypeMode: Fixed-point: binary point scaling
    Signedness: Signed
    WordLength: 16
    FractionLength: 13

```

Input Arguments

a — Input **fi** array

scalar | vector | matrix | multidimensional array

Input **fi** array, specified as scalar, vector, matrix, or multidimensional array.

For complex **fi** objects, the imaginary and real parts are rounded independently.

round does not support **fi** objects with nontrivial slope and bias scaling. Slope and bias scaling is trivial when the slope is an integer power of 2 and the bias is 0.

Data Types: **fi**

Complex Number Support: Yes

q — RoundingMethod and FractionLength settings

quantizer object

RoundingMethod and FractionLength settings, specified as a quantizer object.

Example: `q = quantizer('fixed', 'round', [3 2]);`

x — Input array

scalar | vector | matrix | multidimensional array

Input array to quantize using the quantizer object **q**, specified as a scalar, vector, matrix, or multidimensional array.

Data Types: `single` | `double` | `int8` | `int16` | `int32` | `int64` | `uint8` | `uint16` | `uint32` | `uint64` | `logical`

Complex Number Support: Yes

Algorithms

- **y** and **a** have the same `fimath` object and `DataType` property.
- When the `DataType` property of **a** is `single`, `double`, or `boolean`, the `numericType` of **y** is the same as that of **a**.
- When the fraction length of **a** is zero or negative, **a** is already an integer, and the `numericType` of **y** is the same as that of **a**.
- When the fraction length of **a** is positive, the fraction length of **y** is 0, its sign is the same as that of **a**, and its word length is the difference between the word length and the fraction length of **a**, plus one bit. If **a** is signed, then the minimum word length of **y** is 2. If **a** is unsigned, then the minimum word length of **y** is 1.

Extended Capabilities

C/C++ Code Generation

Generate C and C++ code using MATLAB® Coder™.

HDL Code Generation

Generate Verilog and VHDL code for FPGA and ASIC designs using HDL Coder™.

See Also

`ceil` | `convergent` | `fix` | `floor` | `nearest` | `quantize` | `quantizer`

Introduced before R2006a

rsqrt

Reciprocal square root

Syntax

```
Y = rsqrt(X)
```

Description

`Y = rsqrt(X)` returns the reciprocal square root of each element of the half-precision input array, `X`.

Note This function supports only half-precision inputs.

Examples

Reciprocal Square Root of Matrix Elements

Create a matrix of half-precision values.

```
X = half(magic(3))
```

```
X =
```

```
3x3 half matrix
```

```
     8     1     6
     3     5     7
     4     9     2
```

Compute the reciprocal square root of each element of `X`.

```
y = rsqrt(X)
```

```
y =
```

```
3x3 half matrix
```

```
 0.3535  1.0000  0.4082
 0.5771  0.4473  0.3779
 0.5000  0.3333  0.7070
```

Input Arguments

X — Input array

scalar | vector | matrix | multidimensional array

Input array, specified as a half-precision numeric scalar, vector, matrix, or multidimensional array

Data Types: Half

See Also

half

Introduced in R2018b

savefipref

Save `fi` preferences for next MATLAB session

Syntax

```
savefipref
```

Description

`savefipref` saves the settings of the current `fipref` object for the next MATLAB session.

See Also

`fipref`

Introduced before R2006a

sdec

Signed decimal representation of stored integer of `fi` object

Syntax

`sdec(a)`

Description

Fixed-point numbers can be represented as

$$\text{real-worldvalue} = 2^{-\text{fractionlength}} \times \text{storedinteger}$$

or, equivalently as

$$\text{real-worldvalue} = (\text{slope} \times \text{storedinteger}) + \text{bias}$$

The stored integer is the raw binary number, in which the binary point is assumed to be at the far right of the word.

`sdec(a)` returns the stored integer of `fi` object `a` in signed decimal format.

Examples

The code

```
a = fi([-1 1],1,8,7);  
sdec(a)
```

returns

```
-128  127
```

See Also

`bin` | `dec` | `hex` | `oct` | `storedInteger`

Introduced before R2006a

set

Set or display property values for quantizer objects

Syntax

```
set(q, PropertyValue1, PropertyValue2, ...)
```

```
set(q,s)
```

```
set(q,pn,pv)
```

```
set(q,'PropertyName1',PropertyValue1,'PropertyName2',  
PropertyValue2,...)
```

```
q.PropertyName = Value
```

```
s = set(q)
```

Description

`set(q, PropertyValue1, PropertyValue2, ...)` sets the properties of quantizer object `q`. If two property values conflict, the last value in the list is the one that is set.

`set(q,s)`, where `s` is a structure whose field names are object property names, sets the properties named in each field name with the values contained in the structure.

`set(q,pn,pv)` sets the named properties specified in the cell array of strings `pn` to the corresponding values in the cell array `pv`.

`set(q,'PropertyName1',PropertyValue1,'PropertyName2', PropertyValue2, ...)` sets multiple property values with a single statement.

Note You can use property name/property value string pairs, structures, and property name/property value cell array pairs in the same call to `set`.

`q.PropertyName = Value` uses dot notation to set property `PropertyName` to `Value`.

`set(q)` displays the possible values for all properties of quantizer object `q`.

`s = set(q)` returns a structure containing the possible values for the properties of quantizer object `q`.

Note The `set` function operates on quantizer objects. To learn about setting the properties of other objects, see properties of `fi`, `fimath`, `fipref`, and `numericType` objects.

See Also

`get`

Introduced before R2006a

setfimath

Attach fimath object to fi object

Syntax

```
y = setfimath(x,f)
```

Description

`y = setfimath(x,f)` returns a `fi` object, `y`, with `x`'s `numericType` and value, and attached `fimath` object, `f`. This function and the related `removefimath` function are useful for preventing errors about embedded `.fimath` of both operands needing to be equal.

The `y = setfimath(x,f)` syntax does not modify the input, `x`. To modify `x`, use `x = setfimath(x,f)`. If you use `setfimath` in an expression, such as, `a*setfimath(b,f)`, the `fimath` object is used in the temporary variable, but `b` is not modified.

Examples

Add fimath object to fi Object

Define a `fi` object, define a `fimath` object, and use `setfimath` to attach the `fimath` object to the `fi` object.

Create a `fi` object without a `fimath` object.

```
a = fi(pi)
a =
    3.1416

    DataTypeMode: Fixed-point: binary point scaling
    Signedness: Signed
    WordLength: 16
    FractionLength: 13
```

Create a `fimath` object and attach it to the `fi` object.

```
f = fimath('OverflowAction','Wrap','RoundingMethod','Floor');
b = setfimath(a,f)
b =
    3.1416

    DataTypeMode: Fixed-point: binary point scaling
    Signedness: Signed
    WordLength: 16
    FractionLength: 13

    RoundingMethod: Floor
    OverflowAction: Wrap
```

```
ProductMode: FullPrecision
SumMode: FullPrecision
```

Set and Remove `fimath` for Code Generation

Use the pattern `x = setfimath(x,f)` and `y = removefimath(y)` to insulate variables from `fimath` settings outside the function. This pattern does not create copies of the data in generated code.

```
function y = fixed_point_32bit_KeepLSB_plus_example(a,b)
    f = fimath('OverflowAction','Wrap',...
        'RoundingMethod','Floor',...
        'SumMode','KeepLSB',...
        'SumWordLength',32);
    a = setfimath(a,f);
    b = setfimath(b,f);
    y = a + b;
    y = removefimath(y);
end
```

If you have the MATLAB Coder product, you can generate C code. This example generates C code on a computer with 32-bit, native integer type.

```
a = fi(0,1,16,15);
b = fi(0,1,16,15);
codegen -config:lib fixed_point_32bit_KeepLSB_plus_example...
        -args {a,b} -launchreport
```

```
int fixed_point_32bit_KeepLSB_plus_example(short a, short b)
{
    return a + b;
}
```

Input Arguments

x — Input data

fi object | built-in integer | double | single

Input data, specified as a `fi` object or built-in integer value, from which to copy the data type and value to the output. `x` must be a `fi` object or an integer data type (`int8`, `int16`, `int32`, `int64`, `uint8`, `uint16`, `uint32`, or `uint64`). Otherwise, the `fimath` object is not applied. If `x` is not a `fi` object or integer data type, `y = x`.

f — Input `fimath` object

`fimath` object

Input `fimath` object, specified as an existing `fimath` object to attach to the output. An error occurs if `f` is not a `fimath` object.

Output Arguments

y — Output **fi** object

`fi` object

Output `fi` object, returned as a `fi` object with the same data type and value as the `x` input. `y` also has attached `fi` object, `f`. If the input, `x`, is not a `fi` object or integer data type, then `y = x`.

Extended Capabilities

C/C++ Code Generation

Generate C and C++ code using MATLAB® Coder™.

See Also

`fi` | `fi`math | `removefimath`

Introduced in R2012b

sfi

Construct signed fixed-point numeric object

Syntax

```
a = sfi
a = sfi(v)
a = sfi(v,w)
a = sfi(v,w,f)
a = sfi(v,w,slope,bias)
a = sfi(v,w,slopeadjustmentfactor,fixedexponent,bias)
```

Description

You can use the `sfi` constructor function in the following ways:

- `a = sfi` is the default constructor and returns a signed `fi` object with no value, 16-bit word length, and 15-bit fraction length.
- `a = sfi(v)` returns a signed fixed-point object with value `v`, 16-bit word length, and best-precision fraction length.
- `a = sfi(v,w)` returns a signed fixed-point object with value `v`, word length `w`, and best-precision fraction length.
- `a = sfi(v,w,f)` returns a signed fixed-point object with value `v`, word length `w`, and fraction length `f`.
- `a = sfi(v,w,slope,bias)` returns a signed fixed-point object with value `v`, word length `w`, `slope`, and `bias`.
- `a = sfi(v,w,slopeadjustmentfactor,fixedexponent,bias)` returns a signed fixed-point object with value `v`, word length `w`, `slopeadjustmentfactor`, `fixedexponent`, and `bias`.

`fi` objects created by the `sfi` constructor function have the following general types of properties:

- “Data Properties” on page 4-768
- “fimath Properties” on page 4-707
- “numeric type Properties” on page 4-770

These properties are described in detail in “fi Object Properties” on page 3-2 in the Properties Reference.

Note `fi` objects created by the `sfi` constructor function have no local `fimath`.

Data Properties

The data properties of a `fi` object are always writable.

- `bin` — Stored integer value of a `fi` object in binary

- `data` — Numerical real-world value of a `fi` object
- `dec` — Stored integer value of a `fi` object in decimal
- `double` — Real-world value of a `fi` object, stored as a MATLAB `double`
- `hex` — Stored integer value of a `fi` object in hexadecimal
- `int` — Stored integer value of a `fi` object, stored in a built-in MATLAB integer data type. You can also use `int8`, `int16`, `int32`, `int64`, `uint8`, `uint16`, `uint32`, and `uint64` to get the stored integer value of a `fi` object in these formats
- `oct` — Stored integer value of a `fi` object in octal

These properties are described in detail in “fi Object Properties” on page 3-2.

fimath Properties

When you create a `fi` object with the `sfi` constructor function, that `fi` object does not have a local `fimath` object. You can attach a `fimath` object to that `fi` object if you do not want to use the default `fimath` settings. For more information, see “fimath Object Construction”.

- `fimath` — fixed-point math object

The following `fimath` properties are always writable and, by transitivity, are also properties of a `fi` object.

- `CastBeforeSum` — Whether both operands are cast to the sum data type before addition

Note This property is hidden when the `SumMode` is set to `FullPrecision`.

- `OverflowAction` — Action to take on overflow
- `ProductBias` — Bias of the product data type
- `ProductFixedExponent` — Fixed exponent of the product data type
- `ProductFractionLength` — Fraction length, in bits, of the product data type
- `ProductMode` — Defines how the product data type is determined
- `ProductSlope` — Slope of the product data type
- `ProductSlopeAdjustmentFactor` — Slope adjustment factor of the product data type
- `ProductWordLength` — Word length, in bits, of the product data type
- `RoundingMethod` — Rounding method
- `SumBias` — Bias of the sum data type
- `SumFixedExponent` — Fixed exponent of the sum data type
- `SumFractionLength` — Fraction length, in bits, of the sum data type
- `SumMode` — Defines how the sum data type is determined
- `SumSlope` — Slope of the sum data type
- `SumSlopeAdjustmentFactor` — Slope adjustment factor of the sum data type
- `SumWordLength` — The word length, in bits, of the sum data type

These properties are described in detail in “fimath Object Properties”.

numericType Properties

When you create a `fi` object, a `numericType` object is also automatically created as a property of the `fi` object.

`numericType` — Object containing all the data type information of a `fi` object, Simulink signal or model parameter

The following `numericType` properties are, by transitivity, also properties of a `fi` object. The properties of the `numericType` object become read only after you create the `fi` object. However, you can create a copy of a `fi` object with new values specified for the `numericType` properties.

- `Bias` — Bias of a `fi` object
- `DataType` — Data type category associated with a `fi` object
- `DataTypeMode` — Data type and scaling mode of a `fi` object
- `FixedExponent` — Fixed-point exponent associated with a `fi` object
- `SlopeAdjustmentFactor` — Slope adjustment associated with a `fi` object
- `FractionLength` — Fraction length of the stored integer value of a `fi` object in bits
- `Scaling` — Fixed-point scaling mode of a `fi` object
- `Signed` — Whether a `fi` object is signed or unsigned
- `Signedness` — Whether a `fi` object is signed or unsigned

Note `numericType` objects can have a `Signedness` of `Auto`, but all `fi` objects must be `Signed` or `Unsigned`. If a `numericType` object with `Auto Signedness` is used to create a `fi` object, the `Signedness` property of the `fi` object automatically defaults to `Signed`.

- `Slope` — Slope associated with a `fi` object
- `WordLength` — Word length of the stored integer value of a `fi` object in bits

For further details on these properties, see “`numericType` Object Properties”.

Examples

Note For information about the display format of `fi` objects, refer to `Display Settings`.

For examples of casting, see “`Cast fi Objects`”.

Example 1

For example, the following creates a signed `fi` object with a value of `pi`, a word length of 8 bits, and a fraction length of 3 bits:

```
a = sfi(pi,8,3)
```

```
a =
```

```
3.1250
```

```
DataTypeMode: Fixed-point: binary point scaling
```

```

Signedness: Signed
WordLength: 8
FractionLength: 3

```

Default `fimath` properties are associated with `a`. When a `fi` object does not have a local `fimath` object, no `fimath` object properties are displayed in its output. To determine whether a `fi` object has a local `fimath` object, use the `isfimathlocal` function.

```
isfimathlocal(a)
```

```
ans =
     0
```

A returned value of `0` means the `fi` object does not have a local `fimath` object. When the `isfimathlocal` function returns a `1`, the `fi` object has a local `fimath` object.

Example 2

The value `v` can also be an array:

```
a = sfi((magic(3)/10),16,12)
```

```
a =
```

```

0.8000    0.1001    0.6001
0.3000    0.5000    0.7000
0.3999    0.8999    0.2000

```

```

DataTypeMode: Fixed-point: binary point scaling
Signedness: Signed
WordLength: 16
FractionLength: 12

```

Example 3

If you omit the argument `f`, it is set automatically to the best precision possible:

```
a = sfi(pi,8)
```

```
a =
```

```
3.1563
```

```

DataTypeMode: Fixed-point: binary point scaling
Signedness: Signed
WordLength: 8
FractionLength: 5

```

Example 4

If you omit `w` and `f`, they are set automatically to 16 bits and the best precision possible, respectively:

```
a = sfi(pi)
```

```
a =
```

```
3.1416
```

DataTypeMode: Fixed-point: binary point scaling
 Signedness: Signed
 WordLength: 16
 FractionLength: 13

Extended Capabilities

C/C++ Code Generation

Generate C and C++ code using MATLAB® Coder™.

Usage notes and limitations:

- All properties related to data type must be constant for code generation.

HDL Code Generation

Generate Verilog and VHDL code for FPGA and ASIC designs using HDL Coder™.

See Also

[fi](#) | [fimath](#) | [fipref](#) | [isfimathlocal](#) | [numerictype](#) | [quantizer](#) | [ufi](#)

Introduced in R2009b

shiftdata

Shift data to operate on specified dimension

Syntax

```
[x,perm,nshifts] = shiftdata(x,dim)
```

Description

`[x,perm,nshifts] = shiftdata(x,dim)` shifts data `x` to permute dimension `dim` to the first column using the same permutation as the built-in `filter` function. The vector `perm` returns the permutation vector that is used.

If `dim` is missing or empty, then the first non-singleton dimension is shifted to the first column, and the number of shifts is returned in `nshifts`.

`shiftdata` is meant to be used in tandem with `unshiftdata`, which shifts the data back to its original shape. These functions are useful for creating functions that work along a certain dimension, like `filter`, `goertzel`, `sgolayfilt`, and `sosfilt`.

Examples

Example 1

- 1 Create a 3-x-3 magic square:

```
x = fi(magic(3))
```

```
x =
```

```

     8     1     6
     3     5     7
     4     9     2
```

```

        DataTypeMode: Fixed-point: binary point scaling
        Signedness: Signed
        WordLength: 16
        FractionLength: 11
```

- 2 Shift the matrix `x` to work along the second dimension:

```
[x,perm,nshifts] = shiftdata(x,2)
```

```
x =
```

```

     8     3     4
     1     5     9
     6     7     2
```

```

        DataTypeMode: Fixed-point: binary point scaling
        Signedness: Signed
        WordLength: 16
```

```
        FractionLength: 11
perm =
    2    1
```

```
nshifts =
    []
```

The permutation vector, `perm`, and the number of shifts, `nshifts`, are returned along with the shifted matrix, `x`.

- 3 Shift the matrix back to its original shape:

```
y = unshiftdata(x,perm,nshifts)
```

```
y =
```

```
    8    1    6
    3    5    7
    4    9    2
```

```
        DataTypeMode: Fixed-point: binary point scaling
        Signedness: Signed
        WordLength: 16
        FractionLength: 11
```

Example 2

- 1 Define `x` as a row vector:

```
x = 1:5
```

```
x =
```

```
    1    2    3    4    5
```

- 2 Define `dim` as empty to shift the first non-singleton dimension of `x` to the first column:

```
[x,perm,nshifts] = shiftdata(x,[])
```

```
x =
```

```
    1
    2
    3
    4
    5
```

```
perm =
```

```
    []
```

```
nshifts =
```

1

`x` is returned as a column vector, along with `perm`, the permutation vector, and `nshifts`, the number of shifts.

3 Using `unshiftdata`, restore `x` to its original shape:

```
y = unshiftdata(x,perm,nshifts)
```

```
y =
```

```
1 2 3 4 5
```

See Also

`unshiftdata`

Introduced in R2008a

showfixptsimerrors

Show overflows from most recent fixed-point simulation

Compatibility

Note showfixptsimerrors will be removed in a future release. Use fxptdlg instead.

Syntax

```
showfixptsimerrors
```

Description

The showfixptsimerrors script displays any overflows from the most recent fixed-point simulation. This information is also visible in the Fixed-Point Tool.

See Also

autofixexp | fxptdlg

Introduced before R2006a

showfixptsimranges

Show logged maximum values, minimum values, and overflow data from fixed-point simulation

Compatibility

Note showfixptsimranges will be removed in a future release. Use fxptdlg instead.

Syntax

```
showfixptsimranges  
showfixptsimranges(action)
```

Description

showfixptsimranges displays the logged maximum values, minimum values, and overflow data from the most recent fixed-point simulation in the MATLAB Command Window.

showfixptsimranges(action) stores the logged maximum values, minimum values, and overflow data from the most recent fixed-point simulation in the workspace variable FixPtSimRanges. If action is 'verbose', the logged data also appears in the MATLAB Command Window. If action is 'quiet', no data appears.

See Also

autofixexp | fxptdlg

Introduced before R2006a

showInstrumentationResults

Results logged by instrumented, compiled C code function

Syntax

```
showInstrumentationResults('mex_fcn')  
showInstrumentationResults ('mex_fcn' '-options')  
showInstrumentationResults mex_fcn  
showInstrumentationResults mex_fcn -options
```

Description

`showInstrumentationResults('mex_fcn')` opens the Code Generation Report, showing results from calling the instrumented MEX function `mex_fcn`. Hovering over variables and expressions in the report displays the logged information. The logged information includes minimum and maximum values, proposed fraction or word lengths, percent of current range, and whether the value is always a whole number, depending on which options you specify. If you specify to include them in the `buildInstrumentedMex` function, histograms are also included. The same information is displayed in a summary table in the Variables tab.

`showInstrumentationResults ('mex_fcn' '-options')` specifies options for the instrumentation results section of the Code Generation Report.

`showInstrumentationResults mex_fcn` and `showInstrumentationResults mex_fcn -options` are alternative syntaxes for opening the Code Generation Report.

When you call `showInstrumentationResults`, a file named `instrumentation/mex_fcn/html/index.html` is created. `mex_fcn` is the name of the corresponding instrumented MEX function. Selecting this file opens a web-based version of the Code Generation Report. To open this file from within MATLAB, right-click on the file and select **Open Outside MATLAB**. `showInstrumentationResults` returns an error if the instrumented `mex_fcn` has not yet been called.

Input Arguments

mex_fcn

Instrumented MEX function created using `buildInstrumentedMex`.

options

Instrumentation results options.

-defaultDT <i>T</i>	Default data type to propose for double or single data type inputs, where <i>T</i> is either a numeric type object or one of the following: 'remainFloat', 'double', 'single', 'int8', 'int16', 'int32', 'int64', 'uint8', 'uint16', 'uint32', or 'uint64'. If you specify an int or uint, the signedness and word length are that int or uint value and a fraction length is proposed. The default is remainFloat, which does not propose any data types.
-nocode	Do not display MATLAB code in the printable report. Display only the tables of logged variables. This option only has effect in combination with the -printable option.
-optimizeWholeNumbers	Optimize the word length of variables whose simulation min/max logs indicate that they are always whole numbers.
-percentSafetyMargin <i>N</i>	Safety margin for simulation min/max, where <i>N</i> is a percent value.
-printable	Create and open a printable HTML report. The report opens in the system browser.
-proposeFL	Propose fraction lengths for specified word lengths.
-proposeWL	Propose word lengths for specified fraction lengths.

Examples

Generate an instrumented MEX function, then run a test bench. Call `showInstrumentationResults` to open the Code Generation Report.

Note The logged results from `showInstrumentationResults` are an accumulation of all previous calls to the instrumented MEX function. To clear the log, see `clearInstrumentationResults`.

- 1 Create a temporary directory, then import an example function from Fixed-Point Designer.

```
tempdirObj=fidemo.fiTempdir('showInstrumentationResults')
copyfile(fullfile(matlabroot,'toolbox','fixedpoint',...
    'fidemos','fi_m_radix2fft_withscaling.m'),...
    'testfft.m','f')
```

- 2 Define prototype input arguments.

```
T = numericType('DataType','ScaledDouble','Scaling',...
    'Unspecified');
```

```
n = 128;
x = complex(fi(zeros(n,1),T));
W = coder.Constant(fi(fidemo.fi_radix2twiddles(n),T));
```

- 3 Generate an instrumented MEX function. Use the `-o` option to specify the MEX function name.

```
buildInstrumentedMex testfft -o testfft_instrumented...
    -args {x,W} -histogram
```

- 4 Run a test bench to record instrumentation results. Call `showInstrumentationResults` to open a report. View the simulation minimum and maximum values, proposed fraction length, percent of current range, and whole number status by pausing over a variable in the report.

```
for i=1:20
    x(:) = 2*rand(size(x))-1;
    y = testfft_instrumented(x);
end
```

```
showInstrumentationResults testfft_instrumented...
    -proposeFL -percentSafetyMargin 10
```

The screenshot shows the MATLAB Instrumentation Report interface. The main window displays the source code for `testfft.m`. A tooltip for variable `x` is visible, showing its properties: Size (128 x 1), Class (embedded.fi), Complex (Yes), and Numerical Type (Scaled double: binary point scaling). Below the code, the 'INSTRUMENTATION RESULTS' section is expanded, showing a table of variables with their instrumentation metrics.

Name	Type	Size	Class	DT Mode	Signednes	WL	FL	Proposed Signednes	Proposed WL	Proposed FL	Percent of Current Range	Always Whole Number	Sim Min	Sim Max
x	I/O	128 × 1	complex embedded.fi	ScaledDouble	Signed	16	15	-	-	14	100	No	-0.999852132	0.998897942
w	Input	127 × 1	complex embedded.fi	ScaledDouble	Signed	16	14	-	-	14	51	No	-1	1
n	Local	1 × 1	double	-	-	-	-	-	-	-	-	Yes	128	128
t	Local	1 × 1	double	-	-	-	-	-	-	-	-	Yes	7	7
LL	Local	1 × 7	int32	-	-	-	-	-	-	-	-	Yes	2	128
rr	Local	1 × 7	int32	-	-	-	-	-	-	-	-	Yes	1	64
LL2	Local	1 × 7	int32	-	-	-	-	-	-	-	-	Yes	1	64

- 1 View the histogram for a variable by clicking  in the **Variables** tab.

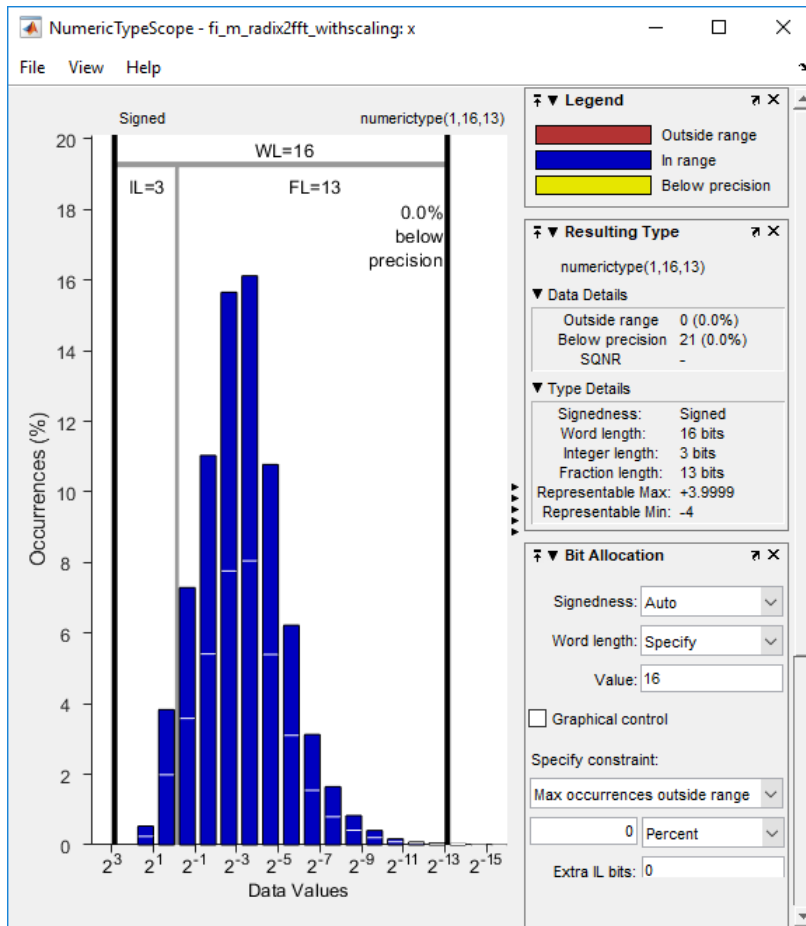

For information on the figure, refer to the NumericTypeScope reference page.

- 2 Close the histogram display and then, clear the results log.

```
clearInstrumentationResults testfft_instrumented
```

- 3 Clear the MEX function, then delete temporary files.

```
clear testfft_instrumented;
tempdirObj.cleanUp;
```

See Also

NumericTypeScope | buildInstrumentedMex | clearInstrumentationResults | codegen | fiaccel | mex

Introduced in R2011b

Simulink.sdi.compareRuns

Package: Simulink.sdi

Compare data in two simulation runs

Syntax

```
diffResult = Simulink.sdi.compareRuns(runID1,runID2)
diffResult = Simulink.sdi.compareRuns(runID1,runID2,Name,Value)
```

Description

`diffResult = Simulink.sdi.compareRuns(runID1,runID2)` compares the data in the runs that correspond to `runID1` and `runID2` and returns the result in the `Simulink.sdi.DiffRunResult` object `diffResult`. The comparison uses the Simulation Data Inspector comparison algorithm. For more information about the algorithm, see “How the Simulation Data Inspector Compares Data”.

`diffResult = Simulink.sdi.compareRuns(runID1,runID2,Name,Value)` compares the simulation runs that correspond to `runID1` and `runID2` using the options specified by one or more `Name,Value` pair arguments. For more information about how the options can affect the comparison, see “How the Simulation Data Inspector Compares Data”.

Examples

Compare Runs with Global Tolerance

You can specify global tolerance values to use when comparing two simulation runs. Global tolerance values are applied to all signals within the run. This example shows how to specify global tolerance values for a run comparison and how to analyze and save the comparison results.

First, load the session file that contains the data to compare. The session file contains data for four simulations of an aircraft longitudinal controller. This example compares data from two runs that use different input filter time constants.

```
Simulink.sdi.load('AircraftExample.mldatx');
```

To access the run data to compare, use the `Simulink.sdi.getAllRunIDs` function to get the run IDs that correspond to the last two simulation runs.

```
runIDs = Simulink.sdi.getAllRunIDs;
runID1 = runIDs(end - 1);
runID2 = runIDs(end);
```

Use the `Simulink.sdi.compareRuns` function to compare the runs. Specify a global relative tolerance value of 0.2 and a global time tolerance value of 0.5.

```
runResult = Simulink.sdi.compareRuns(runID1,runID2,'reltol',0.2,'timetol',0.5);
```

Check the `Summary` property of the returned `Simulink.sdi.DiffRunResult` object to see whether signals were within the tolerance values or out of tolerance.

```
runResult.Summary
ans = struct with fields:
    OutOfTolerance: 0
    WithinTolerance: 3
    Unaligned: 0
    UnitsMismatch: 0
    Empty: 0
    Canceled: 0
    EmptySynced: 0
    DataTypeMismatch: 0
    TimeMismatch: 0
    StartStopMismatch: 0
    Unsupported: 0
```

All three signal comparison results fell within the specified global tolerance.

You can save the comparison results to an MLDATX file using the `saveResult` function.

```
saveResult(runResult, 'InputFilterComparison');
```

Analyze Simulation Data Using Signal Tolerances

You can programmatically specify signal tolerance values to use in comparisons performed using the Simulation Data Inspector. In this example, you compare data collected by simulating a model of an aircraft longitudinal flight control system. Each simulation uses a different value for the input filter time constant and logs the input and output signals. You analyze the effect of the time constant change by comparing results using the Simulation Data Inspector and signal tolerances.

First, load the session file that contains the simulation data.

```
Simulink.sdi.load('AircraftExample.mldatx');
```

The session file contains four runs. In this example, you compare data from the first two runs in the file. Access the `Simulink.sdi.Run` objects for the first two runs loaded from the file.

```
runIDs = Simulink.sdi.getAllRunIDs;
runIDTs1 = runIDs(end-3);
runIDTs2 = runIDs(end-2);
```

Now, compare the two runs without specifying any tolerances.

```
noTolDiffResult = Simulink.sdi.compareRuns(runIDTs1, runIDTs2);
```

Use the `getResultByIndex` function to access the comparison results for the `q` and `alpha` signals.

```
qResult = getResultByIndex(noTolDiffResult, 1);
alphaResult = getResultByIndex(noTolDiffResult, 2);
```

Check the `Status` of each signal result to see whether the comparison result fell within our out of tolerance.

```

qResult.Status

ans =
OutOfTolerance

alphaResult.Status

ans =
OutOfTolerance

```

The comparison used a value of 0 for all tolerances, so the `OutOfTolerance` result means the signals are not identical.

You can further analyze the effect of the time constant by specifying tolerance values for the signals. Specify the tolerances by setting the properties for the `Simulink.sdi.Signal` objects that correspond to the signals being compared. Comparisons use tolerances specified for the baseline signals. This example specifies a time tolerance and an absolute tolerance.

To specify a tolerance, first access the `Signal` objects from the baseline run.

```

runTs1 = Simulink.sdi.getRun(runIDTs1);
qSig = getSignalsByName(runTs1,'q, rad/sec');
alphaSig = getSignalsByName(runTs1,'alpha, rad');

```

Specify an absolute tolerance of 0.1 and a time tolerance of 0.6 for the `q` signal using the `AbsTol` and `TimeTol` properties.

```

qSig.AbsTol = 0.1;
qSig.TimeTol = 0.6;

```

Specify an absolute tolerance of 0.2 and a time tolerance of 0.8 for the `alpha` signal.

```

alphaSig.AbsTol = 0.2;
alphaSig.TimeTol = 0.8;

```

Compare the results again. Access the results from the comparison and check the `Status` property for each signal.

```

tolDiffResult = Simulink.sdi.compareRuns(runIDTs1,runIDTs2);
qResult2 = getResultByIndex(tolDiffResult,1);
alphaResult2 = getResultByIndex(tolDiffResult,2);

```

```

qResult2.Status

ans =
WithinTolerance

alphaResult2.Status

ans =
WithinTolerance

```

Configure Comparisons to Check Metadata

You can use the `Simulink.sdi.compareRuns` function to compare signal data and metadata, including data type and start and stop times. A single comparison may check for mismatches in one

or more pieces of metadata. When you check for mismatches in signal metadata, the `Summary` property of the `Simulink.sdi.DiffRunResult` object may differ from a basic comparison because the `Status` property for a `Simulink.sdi.DiffSignalResult` object can indicate the metadata mismatch. You can configure comparisons using the `Simulink.sdi.compareRuns` function for imported data and for data logged from a simulation.

This example configures a comparison of runs created from workspace data three ways to show how the `Summary` of the `DiffSignalResult` object can provide specific information about signal mismatches.

Create Workspace Data

The `Simulink.sdi.compareRuns` function compares time series data. Create data for a sine wave to use as the baseline signal, using the `timeseries` format. Give the `timeseries` the name `Wave Data`.

```
time = 0:0.1:20;
sig1vals = sin(2*pi/5*time);
sig1_ts = timeseries(sig1vals,time);
sig1_ts.Name = 'Wave Data';
```

Create a second sine wave to compare against the baseline signal. Use a slightly different time vector and attenuate the signal so the two signals are not identical. Cast the signal data to the `single` data type. Also name this `timeseries` object `Wave Data`. The Simulation Data Inspector comparison algorithm will align these signals for comparison using the name.

```
time2 = 0:0.1:22;
sig2vals = single(0.98*sin(2*pi/5*time2));
sig2_ts = timeseries(sig2vals,time2);
sig2_ts.Name = 'Wave Data';
```

Create and Compare Runs in the Simulation Data Inspector

The `Simulink.sdi.compareRuns` function compares data contained in `Simulink.sdi.Run` objects. Use the `Simulink.sdi.createRun` function to create runs in the Simulation Data Inspector for the data. The `Simulink.sdi.createRun` function returns the run ID for each created run.

```
runID1 = Simulink.sdi.createRun('Baseline Run','vars',sig1_ts);
runID2 = Simulink.sdi.createRun('Compare to Run','vars',sig2_ts);
```

You can use the `Simulink.sdi.compareRuns` function to compare the runs. The comparison algorithm converts the signal data to the `double` data type and synchronizes the signal data before computing the difference signal.

```
basic_DRR = Simulink.sdi.compareRuns(runID1,runID2);
```

Check the `Summary` property of the returned `Simulink.sdi.DiffRunResult` object to see the result of the comparison.

```
basic_DRR.Summary
ans = struct with fields:
    OutOfTolerance: 1
    WithinTolerance: 0
    Unaligned: 0
    UnitsMismatch: 0
```

```
        Empty: 0
        Canceled: 0
        EmptySynced: 0
        DataTypeMismatch: 0
        TimeMismatch: 0
        StartStopMismatch: 0
        Unsupported: 0
```

The difference between the signals is out of tolerance.

Compare Runs and Check for Data Type Match

Depending on your system requirements, you may want the data types for signals you compare to match. You can use the `Simulink.sdi.compareRuns` function to configure the comparison algorithm to check for and report data type mismatches.

```
dataType_DRR = Simulink.sdi.compareRuns(runID1,runID2, 'DataType', 'MustMatch');
dataType_DRR.Summary
```

```
ans = struct with fields:
    OutOfTolerance: 0
    WithinTolerance: 0
    Unaligned: 0
    UnitsMismatch: 0
    Empty: 0
    Canceled: 0
    EmptySynced: 0
    DataTypeMismatch: 1
    TimeMismatch: 0
    StartStopMismatch: 0
    Unsupported: 0
```

The result of the signal comparison is now `DataTypeMismatch` because the data for the baseline signal is double data type, while the data for the signal compared to the baseline is single data type.

Compare Runs and Check for Start and Stop Time Match

You can use the `Simulink.sdi.compareRuns` function to configure the comparison algorithm to check whether the aligned signals have the same start and stop times.

```
startStop_DRR = Simulink.sdi.compareRuns(runID1,runID2, 'StartStop', 'MustMatch');
startStop_DRR.Summary
```

```
ans = struct with fields:
    OutOfTolerance: 0
    WithinTolerance: 0
    Unaligned: 0
    UnitsMismatch: 0
    Empty: 0
    Canceled: 0
    EmptySynced: 0
    DataTypeMismatch: 0
    TimeMismatch: 0
    StartStopMismatch: 1
    Unsupported: 0
```

The signal comparison result is now `StartStopMismatch` because the signals created in the workspace have different stop times.

Compare Runs with Alignment Criteria

When you compare runs using the Simulation Data Inspector, you can specify alignment criteria that determine how signals are paired with each other for comparison. This example compares data from simulations of a model of an aircraft longitudinal control system. The simulations used a square wave input. The first simulation used an input filter time constant of `0.1s` and the second simulation used an input filter time constant of `0.5s`.

First, load the simulation data from the session file that contains the data for this example.

```
Simulink.sdi.load('AircraftExample.mldatx');
```

The session file contains data for four simulations. This example compares data from the first two runs. Access the run IDs for the first two runs loaded from the session file.

```
runIDs = Simulink.sdi.getAllRunIDs;
runIDTs1 = runIDs(end-3);
runIDTs2 = runIDs(end-2);
```

Before running the comparison, define how you want the Simulation Data Inspector to align the signals between the runs. This example aligns signals by their name, then by their block path, and then by their Simulink identifier.

```
alignMethods = [Simulink.sdi.AlignType.SignalName
                Simulink.sdi.AlignType.BlockPath
                Simulink.sdi.AlignType.SID];
```

Compare the simulation data in your two runs, using the alignment criteria you specified. The comparison uses a small time tolerance to account for the effect of differences in the step size used by the solver on the transition of the square wave input.

```
diffResults = Simulink.sdi.compareRuns(runIDTs1,runIDTs2,'align',alignMethods,...
    'timetol',0.005);
```

You can use the `getResultByIndex` function to access the comparison results for the aligned signals in the runs you compared. You can use the `Count` property of the `Simulink.sdi.DiffRunResult` object to set up a `for` loop to check the `Status` property for each `Simulink.sdi.DiffSignalResult` object.

```
numComparisons = diffResults.count;
for k = 1:numComparisons
    resultAtIdx = getResultByIndex(diffResults,k);

    sigID1 = resultAtIdx.signalID1;
    sigID2 = resultAtIdx.signalID2;

    sig1 = Simulink.sdi.getSignal(sigID1);
    sig2 = Simulink.sdi.getSignal(sigID2);

    displayStr = 'Signals %s and %s: %s \n';
    fprintf(displayStr,sig1.Name,sig2.Name,resultAtIdx.Status);
end
```

Signals `q`, rad/sec and `q`, rad/sec: `OutOfTolerance`
 Signals `alpha`, rad and `alpha`, rad: `OutOfTolerance`
 Signals `Stick` and `Stick`: `WithinTolerance`

Input Arguments

runID1 — Baseline run identifier

integer

Numeric identifier for the baseline run in the comparison, specified as a run ID that corresponds to a run in the Simulation Data Inspector. The Simulation Data Inspector assigns run IDs when runs are created. You can get the run ID for a run by using the `ID` property of the `Simulink.sdi.Run` object, the `Simulink.sdi.getAllRunIDs` function, or the `Simulink.sdi.getRunIDByIndex` function.

runID2 — Identifier for run to compare

integer

Numeric identifier for the run to compare, specified as a run ID that corresponds to a run in the Simulation Data Inspector. The Simulation Data Inspector assigns run IDs when runs are created. You can get the run ID for a run by using the `ID` property of the `Simulink.sdi.Run` object, the `Simulink.sdi.getAllRunIDs` function, or the `Simulink.sdi.getRunIDByIndex` function.

Name-Value Pair Arguments

Specify optional comma-separated pairs of `Name`, `Value` arguments. `Name` is the argument name and `Value` is the corresponding value. `Name` must appear inside quotes. You can specify several name and value pair arguments in any order as `Name1, Value1, ..., NameN, ValueN`.

Example: `'abstol', x, 'align', alignOpts`

Align — Signal alignment options

string array | character vector array

Signal alignment options, specified as the comma-separated pair consisting of `'Align'` and a string array or array of character vectors.

Array specifying alignment options to use for pairing signals from the runs being compared. The Simulation Data Inspector aligns signals first by the first element in the array, then by the second element in the array, and so on. For more information, see “Signal Alignment”.

Value	Aligns By
<code>Simulink.sdi.AlignType.BlockPath</code>	Path to the source block for the signal
<code>Simulink.sdi.AlignType.SID</code>	Simulink identifier “Simulink Identifiers”
<code>Simulink.sdi.AlignType.SignalName</code>	Signal name
<code>Simulink.sdi.AlignType.DataSource</code>	Path of the variable in the MATLAB workspace

Example: `[Simulink.sdi.AlignType.SignalName, Simulink.sdi.AlignType.SID]` specifies signal alignment by name and then by SID.

AbsTol — Absolute tolerance for comparison

0 (default) | scalar

Positive-valued global absolute tolerance used for all signals in the run comparison, specified as the comma-separated pair consisting of 'AbsTol' and a scalar. For more information about how tolerances are used in comparisons, see “Tolerance Specification”.

Example: 0.5

Data Types: double

RelTol — Relative tolerance for comparison

0 (default) | scalar

Positive-valued global relative tolerance used for all signals in the run comparison, specified as the comma-separated pair consisting of 'RelTol' and a scalar. The relative tolerance is expressed as a fractional multiplier. For example, 0.1 specifies a 10 percent tolerance. For more information about how the relative tolerance is applied in the Simulation Data Inspector, see “Tolerance Specification”.

Example: 0.1

Data Types: double

TimeTol — Time tolerance for comparison

0 (default) | scalar

Positive-valued global time tolerance used for all signals in the run comparison, specified as the comma-separated pair consisting of 'TimeTol' and a scalar. Specify the time tolerance in units of seconds. For more information about tolerances in the Simulation Data Inspector, see “Tolerance Specification”.

Example: 0.2

Data Types: double

DataType — Comparison sensitivity to signal data types

'MustMatch'

Specify the name-value pair 'DataType', 'MustMatch' when you want the comparison to be sensitive to data type mismatches in compared signals. When you specify this name-value pair, the algorithm compares the data types for aligned signals before synchronizing and comparing the signal data.

The `Simulink.sdi.compareRuns` function does not compare the data types of aligned signals unless you specify this name-value pair. The comparison algorithm can compare signals with different data types.

When signal data types do not match, the `Status` property of the `Simulink.sdi.DiffSignalResult` object for the result is set to `DataTypeMismatch`.

When you specify that data types must match and configure the comparison to stop on the first mismatch, a data type mismatch stops the comparison. A stopped comparison may not compute results for all signals.

Time — Comparison sensitivity to signal time vectors

'MustMatch'

Specify the name-value pair 'Time', 'MustMatch' when you want the comparison to be sensitive to mismatches in the time vectors of compared signals. When you specify this name-value pair, the algorithm compares the time vectors of aligned signals before synchronizing and comparing the signal data.

Comparisons are not sensitive to differences in signal time vectors unless you specify this name-value pair. For comparisons that are not sensitive to differences in the time vectors, the comparison algorithm synchronizes the signals prior to the comparison. For more information about how synchronization works, see “How the Simulation Data Inspector Compares Data”.

When the time vectors for signals do not match, the `Status` property of the `Simulink.sdi.DiffSignalResult` object for the result is set to `TimeMismatch`.

When you specify that time vectors must match and configure the comparison to stop on the first mismatch, a time vector mismatch stops the comparison. A stopped comparison may not compute results for all signals.

StartStop — Comparison sensitivity to signal start and stop times

`'MustMatch'`

Specify the name-value pair `'StartStop'`, `'MustMatch'` when you want the comparison to be sensitive to mismatches in signal start and stop times. When you specify this name-value pair, the algorithm compares the start and stop times for aligned signals before synchronizing and comparing the signal data.

When the start times and stop times do not match, the `Status` property of the `Simulink.sdi.DiffSignalResult` object for the result is set to `StartStopMismatch`.

When you specify that start and stop times must match and configure the comparison to stop on the first mismatch, a start or stop time mismatch stops the comparison. A stopped comparison may not compute results for all signals.

StopOnFirstMismatch — Whether comparison stops on first detected mismatch

`'Metadata' | 'Any'`

Whether the comparison stops without comparing remaining signals on the first detected mismatch, specified as the comma-separated pair consisting of `'StopOnFirstMismatch'` and `'Metadata'` or `'Any'`. A stopped comparison may not compute results for all signals, and can return a mismatched result more quickly.

- `Metadata` — A mismatch in metadata for aligned signals causes the comparison to stop. Metadata comparisons happen before comparing signal data.

The Simulation Data Inspector always aligns signals and compares signal units. When you configure the comparison to stop on the first mismatch, an unaligned signal or mismatched units always causes the comparison to stop. You can specify additional name-value pairs to configure the comparison to check and stop on the first mismatch for additional metadata, such as signal data type, start and stop times, and time vectors.

- `Any` — A mismatch in metadata or signal data for aligned signals causes the comparison to stop.

Output Arguments

diffResult — Comparison results

`Simulink.sdi.DiffRunResult`

Comparison results, returned as a `Simulink.sdi.DiffRunResult` object.

Limitations

The Simulation Data Inspector does not support comparing:

- Signals of data types `int64` or `uint64`.
- Variable-size signals.

See Also

`Simulink.sdi.DiffRunResult` | `Simulink.sdi.DiffSignalResult` |
`Simulink.sdi.compareSignals` | `Simulink.sdi.getRunCount` |
`Simulink.sdi.getRunIDByIndex` | `getResultByIndex`

Topics

“Inspect and Compare Data Programmatically”

“Compare Simulation Data”

“How the Simulation Data Inspector Compares Data”

Introduced in R2011b

sin

Sine of fixed-point values

Syntax

```
y = sin(theta)
```

Description

`y = sin(theta)` returns the sine of `fi` input `theta` using a lookup table algorithm.

Examples

Calculate the Sine of Fixed-Point Input Values

```
theta = fi([-pi/2, -pi/3, -pi/4, 0, pi/4, pi/3, pi/2]);  
y = sin(theta)
```

```
y=1x7 object  
-1.0000 -0.8661 -0.7072 0 0.7070 0.8659 0.9999  
  
    DataTypeMode: Fixed-point: binary point scaling  
    Signedness: Signed  
    WordLength: 16  
    FractionLength: 15
```

Input Arguments

theta — Input angle in radians

real-valued `fi` object

Input angle in radians, specified as a real-valued `fi` object. `theta` can be a signed or unsigned scalar, vector, matrix, or multidimensional array containing the fixed-point angle values in radians. Valid data types of `theta` are:

- `fi` single
- `fi` double
- `fi` fixed-point with binary point scaling
- `fi` scaled double with binary point scaling

Data Types: `fi`

Output Arguments

y — Sine of input angle

scalar | vector | matrix | multidimensional array

Sine of input angle, returned as a scalar, vector, matrix, or multidimensional array. y is a signed, fixed-point number in the range $[-1,1]$.

If the `DataTypeMode` property of `theta` is `Fixed-point: binary point scaling`, then y is returned as a signed fixed-point data type with binary point scaling, a 16-bit word length, and a 15-bit fraction length (`numericType(1,16,15)`). If `theta` is a `fi` single, `fi` double, or `fi` scaled double with binary point scaling, then y is returned with the same data type as `theta`.

More About

Sine

The sine of angle Θ is defined as

$$\sin(\theta) = \frac{e^{i\theta} - e^{-i\theta}}{2i}$$

Algorithms

The `sin` function computes the sine of fixed-point input using an 8-bit lookup table as follows:

- 1 Perform a modulo 2π , so the input is in the range $[0,2\pi)$ radians.
- 2 Cast the input to a 16-bit stored integer value, using the 16 most-significant bits.
- 3 Compute the table index, based on the 16-bit stored integer value, normalized to the full `uint16` range.
- 4 Use the 8 most-significant bits to obtain the first value from the table.
- 5 Use the next-greater table value as the second value.
- 6 Use the 8 least-significant bits to interpolate between the first and second values, using nearest-neighbor linear interpolation.

fimath Propagation Rules

The `sin` function ignores and discards any `fimath` attached to the input, `theta`. The output, y , is always associated with the default `fimath`.

Extended Capabilities

C/C++ Code Generation

Generate C and C++ code using MATLAB® Coder™.

See Also

`angle` | `atan2` | `cordiccos` | `cordicsin` | `cos` | `sin`

Topics

“Calculate Fixed-Point Sine and Cosine”

Introduced in R2012a

sign

Perform sign function (signum function) on array

Syntax

```
c = sign(a)
```

Description

`c = sign(a)` returns an array `c` the same size as `a`, where each element of `c` is:

- 1 if the corresponding element of `a` is greater than 0.
- 0 if the corresponding element of `a` is 0.
- -1 if the corresponding element of `a` is less than 0.

The elements of `c` are of data type `int8`.

Examples

Find Sign Function

Find the sign function of a `fi` object.

```
sign(fi(2))
```

```
ans =
```

```
int8
```

```
1
```

Find the sign function of a signed `fi` vector.

```
v = fi([-11 0 1.5],1);
```

```
sign(v)
```

```
ans =
```

```
1×3 int8 row vector
```

```
-1 0 1
```

Find the sign function of an unsigned `fi` vector.

```
u = fi([-11 0 1.5],0);
```

```
sign(u)
```

```
ans =
```

```
1×3 int8 row vector
```

0 0 1

Input Arguments

a — Input array

scalar | vector | matrix | multidimensional array

Input array, specified as a `fi` scalar, vector, matrix, or multidimensional array.

`sign` does not support complex `fi` inputs.

Data Types: `fi`

Extended Capabilities

C/C++ Code Generation

Generate C and C++ code using MATLAB® Coder™.

HDL Code Generation

Generate Verilog and VHDL code for FPGA and ASIC designs using HDL Coder™.

See Also

`abs` | `complex` | `conj`

Introduced before R2006a

single

Single-precision floating-point real-world value of `fi` object

Syntax

`single(a)`

Description

Fixed-point numbers can be represented as

$$\text{real-worldvalue} = 2^{-\text{fractionlength}} \times \text{storedinteger}$$

or, equivalently as

$$\text{real-worldvalue} = (\text{slope} \times \text{storedinteger}) + \text{bias}$$

`single(a)` returns the real-world value of a `fi` object in single-precision floating point.

Extended Capabilities

C/C++ Code Generation

Generate C and C++ code using MATLAB® Coder™.

Usage notes and limitations:

- For the automated workflow, do not use explicit double or single casts in your MATLAB algorithm to insulate functions that do not support fixed-point data types. The automated conversion tool does not support these casts. Instead of using casts, supply a replacement function. For more information, see “Function Replacements”.

See Also

`double`

Introduced before R2006a

sort

Sort elements of real-valued `fi` object in ascending or descending order

Syntax

```
B = sort(A)
B = sort(A,dim)
B = sort( ___,direction)
[B,I] = sort( ___)
```

Description

`B = sort(A)` sorts the elements of the real-valued `fi` object `A` in ascending order.

- If `A` is a vector, then `sort(A)` sorts the vector elements.
- If `A` is a matrix, then `sort(A)` treats the columns of `A` as vectors and sorts each column.
- If `A` is a multidimensional array, then `sort(A)` operates along the first array dimension whose size does not equal 1, treating the elements as vectors.

`B = sort(A,dim)` returns the sorted elements of `A` along dimension `dim`.

`B = sort(___,direction)` returns sorted elements of `A` in the order specified by `direction`.

`[B,I] = sort(___)` also returns a collection of index vectors for any of the previous syntaxes.

Examples

Sort `fi` Vector in Ascending Order

Create a `fi` row vector and sort its elements in ascending order.

```
A = fi([9 0 -7 5 3 8 -10 4 2]);
B = sort(A)
```

```
B =
```

```
   -10    -7     0     2     3     4     5     8     9
```

```
      DataTypeMode: Fixed-point: binary point scaling
      Signedness: Signed
      WordLength: 16
      FractionLength: 11
```

Sort `fi` Matrix Columns in Descending Order

Create a matrix of `fi` values and sort its columns in descending order.

```
A = fi([10 -12 4 8; 6 -9 8 0; 2 3 11 -2; 1 1 9 3]);
B = sort(A, 'descend')
```

```
B =
```

```
    10     3    11     8
     6     1     9     3
     2    -9     8     0
     1   -12     4    -2
```

```
    DataTypeMode: Fixed-point: binary point scaling
    Signedness: Signed
    WordLength: 16
    FractionLength: 11
```

Sort and Index a `fi` Matrix

Create a matrix of `fi` values and sort each of its rows in ascending order.

```
A = fi([3 6 5; 7 -2 4; 1 0 -9]);
[B,I] = sort(A,2)
```

```
B =
```

```
     3     5     6
    -2     4     7
    -9     0     1
```

```
    DataTypeMode: Fixed-point: binary point scaling
    Signedness: Signed
    WordLength: 16
    FractionLength: 11
```

```
I =
```

```
3×3 int32 matrix
```

```
     1     3     2
     2     3     1
     3     2     1
```

`B` contains the sorted values and `I` is a collection of 1-by-3 row index vectors describing the rearrangement of each row of `A`.

Input Arguments

A — Input array

real-valued `fi` object

Input array, specified as a real-valued `fi` object.

- If `A` is a scalar, then `sort(A)` returns `A`.
- If `A` is a vector, then `sort(A)` sorts the vector elements.
- If `A` is a matrix, then `sort(A)` treats the columns of `A` as vectors and sorts each column.

- If `A` is a multidimensional array, then `sort(A)` operates along the first array dimension whose size does not equal 1, treating the elements as vectors.

`sort` does not support complex fixed-point inputs, or pairs of `Name, Value` arguments. Refer to the MATLAB `sort` reference page for more information.

Data Types: `fi`

dim – Dimension to operate along

positive integer scalar

Dimension to operate along, specified as a positive integer scalar. If no value is specified, then the default is the first array dimension whose size does not equal 1.

The dimensions argument must be a built-in data type; it cannot be a `fi` object.

Example: Consider a matrix `A`. `sort(A,1)` sorts the elements in the columns of `A`.

Example: `sort(A,2)` sorts the elements in the rows of `A`.

Data Types: `single` | `double` | `int8` | `int16` | `int32` | `int64` | `uint8` | `uint16` | `uint32` | `uint64`

direction – Sorting direction

'ascend' (default) | 'descend'

Sorting direction, specified as 'ascend' or 'descend'.

Data Types: `char`

Output Arguments

B – Sorted array

scalar | vector | matrix | multidimensional array

Sorted array, returned as a scalar, vector, matrix, or multidimensional array. `B` is the same size and type as `A`. The order of the elements in `B` preserves the order of any equal elements in `A`.

I – Sort index

scalar | vector | matrix | multidimensional array

Sort index, returned as a scalar, vector, matrix, or multidimensional array. `I` is the same size as `A`. The index vectors are oriented along the same dimension that `sort` operates on.

Example: If `A` is a vector, then `B = A(I)`.

Example: If `A` is a 2-by-3 matrix, then `[B,I] = sort(A,2)` sorts the elements in each row of `A`. The output `I` is a collection of 1-by-3 row index vectors describing the rearrangement of each row of `A`.

Extended Capabilities

C/C++ Code Generation

Generate C and C++ code using MATLAB® Coder™.

Usage notes and limitations:

- The dimensions argument must be a built-in type; it cannot be a `fi` object.

See Also

sort

Topics

“Reshaping and Rearranging Arrays”

Introduced in R2008b

sqrt

Square root of `fi` object

Syntax

```
c = sqrt(a)
c = sqrt(a,T)
c = sqrt(a,F)
c = sqrt(a,T,F)
```

Description

This function computes the square root of a `fi` object using a bisection algorithm.

`c = sqrt(a)` returns the square root of `fi` object `a`. Intermediate quantities are calculated using the `fimath` associated with `a`. The `numericType` object of `c` is determined automatically using an “Internal Rule” on page 4-740.

`c = sqrt(a,T)` returns the square root of `fi` object `a` with `numericType` object `T`. Intermediate quantities are calculated using the `fimath` associated with `a`. See “Data Type Propagation Rules” on page 4-740.

`c = sqrt(a,F)` returns the square root of `fi` object `a`. Intermediate quantities are calculated using the `fimath` object `F`. The `numericType` object of `c` is determined automatically using an “Internal Rule” on page 4-740.

When `a` is a built-in double or single data type, this syntax is equivalent to `c = sqrt(a)` and the `fimath` object `F` is ignored.

`c = sqrt(a,T,F)` returns the square root `fi` object `a` with `numericType` object `T`. Intermediate quantities are also calculated using the `fimath` object `F`. See “Data Type Propagation Rules” on page 4-740.

Input Arguments

a – Input `fi` array

scalar | vector | matrix | multidimensional array

Input `fi` array, specified as a scalar, vector, matrix, or multidimensional array.

`sqrt` does not support complex, negative-valued, or [Slope Bias] inputs.

Example: `a = fi(pi,1,8,3)`

Data Types: `fi`

T – `numericType` of output

`numericType` object

`numericType` of the output `c`, specified as a `numericType` object.

Example: `T = numericType(1,32,30)`

F — fimath used for calculations of intermediate quantities

`fimath` object

`fimath` used for calculations of intermediate quantities, specified as a `fimath` object.

Example: `F = fimath('OverflowAction','Saturate','RoundingMethod','Convergent')`

Algorithms**Internal Rule**

For syntaxes where the `numericType` object of the output is not specified as an input to the `sqrt` function, it is automatically calculated according to the following internal rule:

$$sign_c = sign_a$$

$$WL_c = \text{ceil}\left(\frac{WL_a}{2}\right)$$

$$FL_c = WL_c - \text{ceil}\left(\frac{WL_a - FL_a}{2}\right)$$

Data Type Propagation Rules

For syntaxes for which you specify a `numericType` object `T`, the `sqrt` function follows the data type propagation rules listed in the following table. In general, these rules can be summarized as “floating-point data types are propagated.” This allows you to write code that can be used with both fixed-point and floating-point inputs.

Data Type of Input <code>fi</code> Object <code>a</code>	Data Type of <code>numericType</code> object <code>T</code>	Data Type of Output <code>c</code>
Built-in double	Any	Built-in double
Built-in single	Any	Built-in single
<code>fi Fixed</code>	<code>fi Fixed</code>	Data type of <code>numericType</code> object <code>T</code>
<code>fi ScaledDouble</code>	<code>fi Fixed</code>	<code>ScaledDouble</code> with properties of <code>numericType</code> object <code>T</code>
<code>fi double</code>	<code>fi Fixed</code>	<code>fi double</code>
<code>fi single</code>	<code>fi Fixed</code>	<code>fi single</code>
Any <code>fi</code> data type	<code>fi double</code>	<code>fi double</code>
Any <code>fi</code> data type	<code>fi single</code>	<code>fi single</code>

Extended Capabilities**C/C++ Code Generation**

Generate C and C++ code using MATLAB® Coder™.

Usage notes and limitations:

- Complex and [Slope Bias] inputs error out.

- Negative inputs yield a 0 result for generated C code.
- Negative inputs error out for MATLAB Executable (MEX) code.

HDL Code Generation

Generate Verilog and VHDL code for FPGA and ASIC designs using HDL Coder™.

See Also

`fi` | `fimath` | `numerictype`

Introduced in R2006b

storedInteger

Stored integer value of `fi` object

Syntax

```
st_int = storedInteger(f)
```

Description

`st_int = storedInteger(f)` returns the stored integer value of `fi` object `f`.

Fixed-point numbers can be represented as

$$real\text{-}worldvalue = 2^{-fractionlength} \times storedinteger$$

or, equivalently as

$$real\text{-}worldvalue = (slope \times storedinteger) + bias$$

The stored integer is the raw binary number, in which the binary point is assumed to be at the far right of the word.

Input Arguments

f — Fixed-point numeric object

`fi` object

Fixed-point numeric object from which you want to get the stored integer value.

Output Arguments

st_int — Stored integer value of `fi` object

integer

Stored integer value of `fi` object, specified as an integer.

Data Types: `int8` | `int16` | `int32` | `int64` | `uint8` | `uint16` | `uint32` | `uint64`

The returned stored integer value is the smallest built-in integer data type in which the stored integer value `f` fits. Signed `fi` values return stored integers of type `int8`, `int16`, `int32`, or `int64`.

Unsigned `fi` values return stored integers of type `uint8`, `uint16`, `uint32`, or `uint64`. The return type is determined based on the stored integer word length (WL):

- $WL \leq 8$ bits, the return type is `int8` or `uint8`.
- $8 \text{ bits} < WL \leq 16$ bits, the return type is `int16` or `uint16`.
- $16 \text{ bits} < WL \leq 32$ bits, the return type is `int32` or `uint32`.
- $32 \text{ bits} < WL \leq 64$ bits, the return type is `int64` or `uint64`.

Note When the word length is greater than 64 bits, the `storedInteger` function errors. For bit-true integer representation of very large word lengths, use `bin`, `oct`, `dec`, `hex`, or `sdec`.

Examples

Stored Integer Value of fi Objects

Find the stored integer values for two `fi` objects. Use the `class` function to display the stored integer data types.

```
x = fi([0.2 0.3 0.5 0.3 0.2]);
in_x = storedInteger(x);
c1 = class(in_x)

numtp = numerictype('WordLength',17);
x_n = fi([0.2 0.3 0.5 0.3 0.2], 'numerictype', numtp);
in_xn = storedInteger(x_n);
c2 = class(in_xn)
```

Extended Capabilities

C/C++ Code Generation

Generate C and C++ code using MATLAB® Coder™.

See Also

[int16](#) | [int32](#) | [int64](#) | [int8](#) | [storedIntegerToDouble](#) | [uint16](#) | [uint32](#) | [uint64](#) | [uint8](#)

Introduced in R2012a

storedIntegerToDouble

Convert stored integer value of `fi` object to built-in double value

Syntax

```
d = storedIntegerToDouble(f)
```

Description

`d = storedIntegerToDouble(f)` converts the stored integer value of `fi` object, `f`, to a double-precision floating-point value, `d`.

If the input word length is greater than 52 bits, a quantization error may occur. `INF` is returned if the stored integer value of the input `fi` object is outside the representable range of built-in double values.

Input Arguments

f

`fi` object

Examples

Convert Stored Integer Value of `fi` Object to Double-Precision Value

Convert the stored integer of a `fi` value to a double-precision value. Use the `class` function to verify that the stored integer is a double-precision value.

```
f = fi(pi,1,16,12);  
d = storedIntegerToDouble(f);  
dtype = class(d)
```

```
dtype =  
'double'
```

Extended Capabilities

C/C++ Code Generation

Generate C and C++ code using MATLAB® Coder™.

See Also

`class` | `fi` | `storedInteger`

Introduced in R2012a

stripscaling

Stored integer of `fi` object

Syntax

```
I = stripscaling(a)
```

Description

`I = stripscaling(a)` returns the stored integer of `a` as a `fi` object with binary-point scaling, zero fraction length and the same word length and sign as `a`.

Examples

`stripscaling` is useful for converting the value of a `fi` object to its stored integer value.

```
fipref('NumericTypeDisplay','short', ...
       'FimathDisplay','none');
format long g
a = fi(0.1,true,48,47)

a =

    0.10000000000000001
    numerictype(1,48,47)

b = stripscaling(a)

b =

    14073748835533
    numerictype(1,48,0)

bin(a)

ans =

    '0000110011001100110011001100110011001100110011001101'
```

```
bin(b)

ans =

    '0000110011001100110011001100110011001100110011001101'
```

Notice that the stored integer values of `a` and `b` are identical, while their real-world values are different.

Introduced before R2006a

sub

Subtract two `fi` objects using `fimath` object

Syntax

```
c = sub(F,a,b)
```

Description

`c = sub(F,a,b)` subtracts `fi` objects `a` and `b` using `fimath` object `F`. This is helpful in cases when you want to override the `fimath` objects of `a` and `b`, or if the `fimath` properties associated with `a` and `b` are different. The output of `fi` object `c` has no local `fimath`.

Examples

Subtract Two `fi` Objects Overriding Their `fimath`

```
a = fi(pi);
b = fi(exp(1));
F = fimath('SumMode','SpecifyPrecision',...
          'SumWordLength',32,'SumFractionLength',16);
c = sub(F,a,b)

c =
    0.4233

      DataTypeMode: Fixed-point: binary point scaling
      Signedness: Signed
      WordLength: 32
      FractionLength: 16
```

`c` is the 32-bit difference of `a` and `b`, with fraction length 16.

Input Arguments

F — `fimath`

`fimath` object

`fimath` object to use for subtraction, specified as a `fimath` object.

a,b — Operands

scalars | vectors | matrices | multidimensional arrays

Operands, specified as scalars, vectors, matrices, or multidimensional arrays.

`a` and `b` must both be `fi` objects and must have the same dimensions unless one is a scalar. If either `a` or `b` is scalar, then `c` has the dimensions of the nonscalar object.

Data Types: `fi`

Complex Number Support: Yes

Algorithms

```
C = sub(F,A,B)
```

or

```
C = F.sub(A,B)
```

is equivalent to

```
A.fimath = F;
```

```
B.fimath = F;
```

```
C = A - B;
```

except that the `fimath` properties of `A` and `B` are not modified when you use the functional form.

Extended Capabilities

C/C++ Code Generation

Generate C and C++ code using MATLAB® Coder™.

Usage notes and limitations:

- Code generation does not support the syntax `F.sub(a,b)`. You must use the syntax `sub(F,a,b)`.

HDL Code Generation

Generate Verilog and VHDL code for FPGA and ASIC designs using HDL Coder™.

See Also

[add](#) | [divide](#) | [fi](#) | [fimath](#) | [mpy](#) | [mrdivide](#) | [numerictype](#) | [rdivide](#)

Introduced before R2006a

subsasgn

Subscripted assignment

Syntax

```
a(I) = b
a(I,J) = b
a(I,:) = b
a(:,I) = b
a(I,J,K,...) = b
a = subsasgn(a,S,b)
```

Description

`a(I) = b` assigns the values of `b` into the elements of `a` specified by the subscript vector `I`. `b` must have the same number of elements as `I` or be a scalar value.

`a(I,J) = b` assigns the values of `b` into the elements of the rectangular submatrix of `a` specified by the subscript vectors `I` and `J`. `b` must have `LENGTH(I)` rows and `LENGTH(J)` columns.

A colon used as a subscript, as in `a(I,:) = b` or `a(:,I) = b` indicates the entire column or row.

For multidimensional arrays, `a(I,J,K,...) = b` assigns `b` to the specified elements of `a`. `b` must be `length(I)-by-length(J)-by-length(K)-...` or be shiftable to that size by adding or removing singleton dimensions.

`a = subsasgn(a,S,b)` is called for the syntax `a(i)=b`, `a{i}=b`, or `a.i=b` when `a` is an object. `S` is a structure array with the following fields:

- `type` — One of the following: `'()''`, `'{}'`, or `'.'` specifying the subscript type
- `subs` — Cell array or character vector containing the actual subscripts

For instance, the syntax `a(1:2,:) = b` calls `a=subsasgn(a,S,b)` where `S` is a 1-by-1 structure with `S.type='()''` and `S.subs = {1:2, ':'}`. A colon used as a subscript is passed as `':'`.

You can use fixed-point assignment, for example `a(:) = b`, to cast a value with one `numericType` object into another `numericType` object. This subscripted assignment statement assigns the value of `b` into `a` while keeping the `numericType` object of `a`. Subscripted assignment works the same way for integer data types.

Examples

Cast a 16-bit Number into an 8-bit Number

For `fi` objects `a` and `b`, there is a difference between

```
a = b
```

and

```
a(:) = b
```

In the first case, `a = b` replaces `a` with `b` while `a` assumes the value, `numericType` object and `fiMath` object associated with `b`. In the second case, `a(:) = b` assigns the value of `b` into `a` while keeping the `numericType` object of `a`. You can use this to cast a value with one `numericType` object into another `numericType` object.

For example, cast a 16-bit number into an 8-bit number.

```
a = fi(0, 1, 8, 7)
```

```
a =
```

```
0
```

```
      DataTypeMode: Fixed-point: binary point scaling
      Signedness: Signed
      WordLength: 8
      FractionLength: 7
```

```
b = fi(pi/4, 1, 16, 15)
```

```
b =
```

```
0.7854
```

```
      DataTypeMode: Fixed-point: binary point scaling
      Signedness: Signed
      WordLength: 16
      FractionLength: 15
```

```
a(:) = b
```

```
a =
```

```
0.7891
```

```
      DataTypeMode: Fixed-point: binary point scaling
      Signedness: Signed
      WordLength: 8
      FractionLength: 7
```

Emulate a 40-bit Accumulator of a DSP

This example defines a variable `acc` to emulate a 40-bit accumulator of a DSP. The products and sums in this example are assigned into the accumulator using the syntax `acc(1)=...`. Assigning values into the accumulator is like storing a value in a register. To begin, turn the logging mode on and define the variables. In this example, `n` is the number of points in the input data `x` and output data `y`, and `t` represents time. The remaining variables are all defined as `fi` objects. The input data `x` is a high-frequency sinusoid added to a low-frequency sinusoid.

```
fipref('LoggingMode', 'on');
n = 100;
t = (0:n-1)/n;
x = fi(sin(2*pi*t) + 0.2*cos(2*pi*50*t));
b = fi([.5 .5]);
y = fi(zeros(size(x)), numericType(x));
acc = fi(0.0, true, 40, 30);
```

The following loop takes a running average of the input x using the coefficients in b . Notice that `acc` is assigned into `acc(1)=...` versus using `acc=...`, which would overwrite and change the data type of `acc`.

```
for k = 2:n
    acc(1) = b(1)*x(k);
    acc(1) = acc + b(2)*x(k-1);
    y(k) = acc;
end
```

By averaging every other sample, the loop shown above passes the low-frequency sinusoid through and attenuates the high-frequency sinusoid.

```
plot(t,x,'x-',t,y,'o-')
legend('input data x','output data y')
```

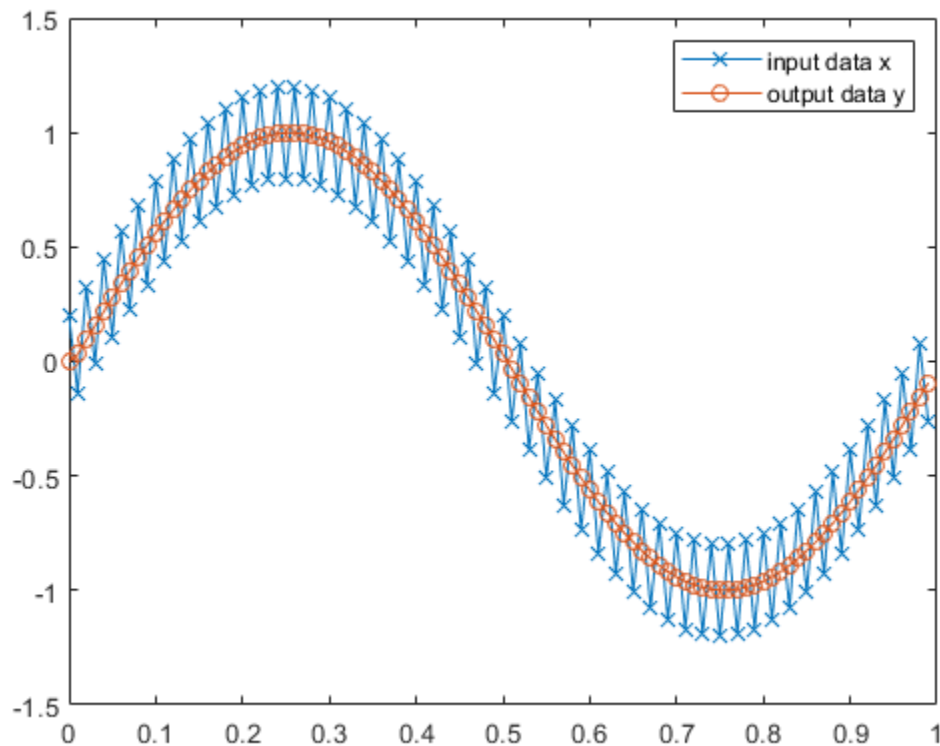

The log report shows the minimum and maximum logged values and ranges of the variables used. Because `acc` is assigned into, rather than overwritten, these logs reflect the accumulated minimum and maximum values.

```
logreport(x, y, b, acc)
```

	minlog	maxlog	lowerbound	upperbound	noverflows	nunderflows
x	-1.200012	1.197998	-2	1.999939	0	0
y	-0.9990234	0.9990234	-2	1.999939	0	0
b	0.5	0.5	-1	0.9999695	0	0
acc	-0.9990234	0.9989929	-512	512	0	0

Display `acc` to verify that its data type did not change.

```
acc
```

```
acc =  
    -0.0941
```

```
        DataTypeMode: Fixed-point: binary point scaling  
        Signedness: Signed  
        WordLength: 40  
        FractionLength: 30
```

Reset the `fipref` object to restore its default values.

```
reset(fipref)
```

Extended Capabilities

C/C++ Code Generation

Generate C and C++ code using MATLAB® Coder™.

GPU Code Generation

Generate CUDA® code for NVIDIA® GPUs using GPU Coder™.

HDL Code Generation

Generate Verilog and VHDL code for FPGA and ASIC designs using HDL Coder™.

Supported data types for HDL code generation are listed in “Supported MATLAB Data Types, Operators, and Control Flow Statements” (HDL Coder).

See Also

`subsref`

Topics

“Cast fi Objects”

Introduced before R2006a

subsref

Subscripted reference

Description

This function accepts `fi` objects as inputs.

Refer to the MATLAB `subsref` reference page for more information.

Extended Capabilities

C/C++ Code Generation

Generate C and C++ code using MATLAB® Coder™.

GPU Code Generation

Generate CUDA® code for NVIDIA® GPUs using GPU Coder™.

HDL Code Generation

Generate Verilog and VHDL code for FPGA and ASIC designs using HDL Coder™.

Supported data types for HDL code generation are listed in “Supported MATLAB Data Types, Operators, and Control Flow Statements” (HDL Coder).

Introduced before R2006a

sum

Sum of *fi* array elements

Syntax

```
S = sum(A)
S = sum(A,dim)
S = sum( ___, type)
```

Description

`S = sum(A)` returns the sum along different dimensions of the *fi* array *A*.

- If *A* is a vector, `sum(A)` returns the sum of the elements.
- If *A* is a matrix, `sum(A)` treats the columns of *A* as vectors, returning a row vector of the sums of each column.
- If *A* is a multidimensional array, `sum(A)` treats the values along the first non-singleton dimension as vectors, returning an array of row vectors.

`S = sum(A,dim)` sums along the dimension *dim* of *A*.

`S = sum(___, type)` returns an array in the class specified by *type*.

Examples

Sum of Vector Elements

Create a *fi* vector, and specify *fimath* properties in the constructor.

```
A=fi([1 2 5 8 5], 'SumMode', 'KeepLSB', 'SumWordLength', 32)
```

```
A=1x5 object
    1     2     5     8     5

    DataTypeMode: Fixed-point: binary point scaling
    Signedness: Signed
    WordLength: 16
    FractionLength: 11

    RoundingMethod: Nearest
    OverflowAction: Saturate
    ProductMode: FullPrecision
    SumMode: KeepLSB
    SumWordLength: 32
    CastBeforeSum: true
```

Compute the sum of the elements of *A*.

```
S=sum(A)
```

```

S =
    21

    DataTypeMode: Fixed-point: binary point scaling
      Signedness: Signed
      WordLength: 32
    FractionLength: 11

    RoundingMethod: Nearest
    OverflowAction: Saturate
      ProductMode: FullPrecision
      SumMode: KeepLSB
    SumWordLength: 32
    CastBeforeSum: true

```

The output *S* is a scalar with the specified *SumWordLength* of 32. The *FractionLength* of *S* is 11 because *SumMode* was set to *KeepLSB*.

Sum of Elements in Each Column

Create a *fi* array, and compute the sum of the elements in each column.

```
A=fi([1 2 8;3 7 0;1 2 2])
```

```

A=3×3 object
    1     2     8
    3     7     0
    1     2     2

    DataTypeMode: Fixed-point: binary point scaling
      Signedness: Signed
      WordLength: 16
    FractionLength: 11

```

```
S=sum(A)
```

```

S=1×3 object
    5    11    10

    DataTypeMode: Fixed-point: binary point scaling
      Signedness: Signed
      WordLength: 18
    FractionLength: 11

```

MATLAB® returns a row vector with the sums of each column of *A*. The *WordLength* of *S* has increased by two bits because $\text{ceil}(\log_2(\text{size}(A,1)))=2$. The *FractionLength* remains the same because the default setting of *SumMode* is *FullPrecision*.

Sum of Elements in Each Row

Compute the sum along the second dimension (*dim=2*) of 3-by-3 matrix *A*.

```
A=fi([1 2 8;3 7 0;1 2 2])
```

```
A=3×3 object
```

```
 1     2     8
 3     7     0
 1     2     2
```

```
      DataTypeMode: Fixed-point: binary point scaling
      Signedness: Signed
      WordLength: 16
      FractionLength: 11
```

```
S=sum(A, 2)
```

```
S=3×1 object
```

```
11
10
 5
```

```
      DataTypeMode: Fixed-point: binary point scaling
      Signedness: Signed
      WordLength: 18
      FractionLength: 11
```

MATLAB® returns a column vector of the sums of the elements in each row. The `WordLength` of `S` is 18 because `ceil(log2(size(A,2)))=2`.

Sum of Elements Preserving Data Type

Compute the sums of the columns of `A` so that the output array, `S`, has the same data type.

```
A=fi([1 2 8;3 7 0;1 2 2]), class(A)
```

```
A=3×3 object
```

```
 1     2     8
 3     7     0
 1     2     2
```

```
      DataTypeMode: Fixed-point: binary point scaling
      Signedness: Signed
      WordLength: 16
      FractionLength: 11
```

```
ans =
'embedded.fi'
```

```
S=sum(A, 'native'), class(S)
```

```
S=1×3 object
```

```
 5    11    10
```

```
      DataTypeMode: Fixed-point: binary point scaling
      Signedness: Signed
```

```
WordLength: 18  
FractionLength: 11
```

```
ans =  
'embedded.fi'
```

MATLAB® preserves the data type of `A` and returns a row vector `S` of type `embedded.fi`.

Input Arguments

A — Input `fi` array

`fi` object | numeric variable

`fi` input array, specified as a scalar, vector, matrix, or multidimensional array.

Data Types: `single` | `double` | `int8` | `int16` | `int32` | `int64` | `uint8` | `uint16` | `uint32` | `uint64` | `fi`

Complex Number Support: Yes

dim — Dimension to operate along

positive integer scalar

Dimension to operate along, specified as a positive integer scalar. `dim` can also be a `fi` object. If no value is specified, the default is the first array dimension whose size does not equal 1.

Data Types: `single` | `double` | `int8` | `int16` | `int32` | `int64` | `uint8` | `uint16` | `uint32` | `uint64` | `fi`

type — Output class

'double' | 'native'

Output class, specified as 'double' or 'native'. The output class defines the data type that the operation is performed in and returned in.

- If `type` is 'double', then `sum` returns a double-precision array, regardless of the input data type.
- If `type` is 'native', then `sum` returns an array with the same class as input array `A`.

Data Types: `char`

Output Arguments

S — Sum array

scalar | vector | matrix | multidimensional array

Sum array, returned as a scalar, vector, matrix, or multidimensional array.

Note The `fimath` object is used in the calculation of the sum. If `SumMode` is set to `FullPrecision`, `KeepLSB`, or `KeepMSB`, then the number of integer bits of growth for `sum(A)` is `ceil(log2(size(A,dim)))`.

Limitations

- `sum` does not support `fi` objects of data type `Boolean`.

Extended Capabilities

C/C++ Code Generation

Generate C and C++ code using MATLAB® Coder™.

Usage notes and limitations:

- Variable-sized inputs are only supported when the `SumMode` property of the governing `fimath` object is set to `SpecifyPrecision` or `KeepLSB`.

HDL Code Generation

Generate Verilog and VHDL code for FPGA and ASIC designs using HDL Coder™.

See Also

`add` | `divide` | `fi` | `fimath` | `mpy` | `mrdivide` | `numericType` | `rdivide` | `sub` | `sum`

Introduced before R2006a

times, .*

Element-by-element multiplication of `fi` objects

Syntax

```
C = A.*B
C = times(A,B)
```

Description

`C = A.*B` performs element-by-element multiplication of `A` and `B`, and returns the result in `C`.

`C = times(A,B)` is an alternate way to execute `A.*B`.

Examples

Multiply a `fi` Object by a Scalar

Use the `times` function to perform element-by-element multiplication of a `fi` object and a scalar.

```
a=4;
b=fi([2 4 7; 9 0 2])
```

```
b=2x3 object
```

```
  2     4     7
  9     0     2
```

```
      DataTypeMode: Fixed-point: binary point scaling
      Signedness: Signed
      WordLength: 16
      FractionLength: 11
```

`a` is a scalar double, and `b` is a matrix of `fi` objects. When doing arithmetic between a `fi` and a double, the double is cast to a `fi` with the same word length and signedness of the `fi`, and best-precision fraction length. The result of the operation is a `fi`.

```
c=a.*b
```

```
c=2x3 object
```

```
  8    16    28
 36     0     8
```

```
      DataTypeMode: Fixed-point: binary point scaling
      Signedness: Signed
      WordLength: 32
      FractionLength: 23
```

During the operation, `a` was cast to a `fi` object with wordlength 16. The output, `c`, is a `fi` object with word length 32, the sum of the word lengths of the two multiplicands, `a` and `b`. This is because the default setting of `ProductMode` in `fimath` is `FullPrecision`.

Multiply Two fi Objects

Use the `times` function to perform element-by-element multiplication of two `fi` objects.

```
a=fi([5 9 9; 1 2 -3], 1, 16, 3)
```

```
a=2x3 object
```

```
5    9    9
1    2   -3
```

```
    DataTypeMode: Fixed-point: binary point scaling
    Signedness: Signed
    WordLength: 16
    FractionLength: 3
```

```
b=fi([2 4 7; 9 0 2], 1, 16, 3)
```

```
b=2x3 object
```

```
2    4    7
9    0    2
```

```
    DataTypeMode: Fixed-point: binary point scaling
    Signedness: Signed
    WordLength: 16
    FractionLength: 3
```

```
c=a.*b
```

```
c=2x3 object
```

```
10   36   63
9    0   -6
```

```
    DataTypeMode: Fixed-point: binary point scaling
    Signedness: Signed
    WordLength: 32
    FractionLength: 6
```

The word length and fraction length of `c` are equal to the sums of the word lengths and fraction lengths of `a` and `b`. This is because the default setting of `ProductMode` in `fimath` is `FullPrecision`.

Input Arguments

A — Input array

scalar | vector | matrix | multidimensional array

Input array, specified as a scalar, vector, matrix, or multidimensional array of `fi` objects or built-in data types. `A` and `B` must have the same dimensions unless one is a scalar value.

Data Types: `fi` | `single` | `double` | `int8` | `int16` | `int32` | `int64` | `uint8` | `uint16` | `uint32` | `uint64`

Complex Number Support: Yes

B – Input array

scalar | vector | matrix | multidimensional array

Input array, specified as a scalar, vector, matrix, or multidimensional array of `fi` objects or built-in data types. A and B must have the same dimensions unless one is a scalar value.

Data Types: `fi` | `single` | `double` | `int8` | `int16` | `int32` | `int64` | `uint8` | `uint16` | `uint32` | `uint64`

Complex Number Support: Yes

Output Arguments

C – Output array

scalar | vector | matrix | multidimensional array

Output array, returned as a scalar, vector, matrix, or multidimensional array.

Extended Capabilities

C/C++ Code Generation

Generate C and C++ code using MATLAB® Coder™.

Usage notes and limitations:

- Any non-`fi` input must be constant; that is, its value must be known at compile time so that it can be cast to a `fi` object.
- When you provide complex inputs to the `times` function inside of a MATLAB Function block, you must declare the input as complex before running the simulation. To do so, go to the **Ports and data manager** and set the **Complexity** parameter for all known complex inputs to `On`.

HDL Code Generation

Generate Verilog and VHDL code for FPGA and ASIC designs using HDL Coder™.

See Also

`minus` | `mtimes` | `plus` | `uminus`

Introduced before R2006a

toeplitz

Create Toeplitz matrix

Syntax

```
t = toeplitz(a,b)
t = toeplitz(b)
```

Description

`t = toeplitz(a,b)` returns a nonsymmetric Toeplitz matrix with `a` as its first column and `b` as its first row. `b` is cast to the `numericType` of `a`. If one of the arguments of `toeplitz` is a built-in data type, it is cast to the data type of the `fi` object. If the first elements of `a` and `b` differ, `toeplitz` issues a warning and uses the column element for the diagonal.

`t = toeplitz(b)` returns the symmetric or Hermitian Toeplitz matrix formed from vector `b`, where `b` is the first row of the matrix.

Examples

Create Symmetric Toeplitz Matrix

```
r = fi([1 2 3]);
toeplitz(r)
```

```
    1    2    3
```

```
    DataTypeMode: Fixed-point: binary point scaling
    Signedness: Signed
    WordLength: 16
    FractionLength: 13
```

```
    RoundingMethod: Nearest
    OverflowAction: Saturate
    ProductMode: FullPrecision
    SumMode: FullPrecision
```

```
    Tag:
```

```
ans =
```

```
    1    2    3
    2    1    2
    3    2    1
    numericType(1,16,13)
```

Create Nonsymmetric Toeplitz Matrix

Create a nonsymmetric Toeplitz matrix with a specified column and row vector.

`toeplitz(a,b)` casts `b` into the data type of `a`. In this example, overflow occurs:

```
fipref('NumericTypeDisplay','short');
format short g
a = fi([1 2 3],true,8,5)
b = fi([1 4 8],true,16,10)
toeplitz(a,b)
```

a =

```
1 2 3
numerictype(1,8,5)
```

b =

```
1 4 8
numerictype(1,16,10)
```

ans =

```
1 3.9688 3.9688
2 1 3.9688
3 2 1
numerictype(1,8,5)
```

`toeplitz(b,a)` casts `a` into the data type of `b`. In this example, overflow does not occur:

```
toeplitz(b,a)
```

ans =

```
1 2 3
4 1 2
8 4 1
numerictype(1,16,10)
```

If one of the arguments of `toeplitz` is a built-in data type, it is cast to the data type of the `fi` object.

```
x = double([1 exp(1) pi]);
toeplitz(a,x)
```

ans =

```
1 2.7188 3.1563
2 1 2.7188
3 2 1
numerictype(1,8,5)
```

Input Arguments

a — Column of Toeplitz matrix

scalar | vector

Column of Toeplitz matrix, specified as a scalar or vector. If the first elements of `a` and `b` differ, `toeplitz` uses the column element for the diagonal.

Data Types: `fi`

Complex Number Support: Yes

b — Row of Toeplitz matrix

scalar | vector

Row of Toeplitz matrix, specified as a scalar or vector. If the first elements of `a` and `b` differ, `toeplitz` uses the column element for the diagonal.

Data Types: `single` | `double` | `int8` | `int16` | `int32` | `int64` | `uint8` | `uint16` | `uint32` | `uint64` | `fi`

Complex Number Support: Yes

Output Arguments

t — Toeplitz matrix

`fi` object

Toeplitz matrix, returned as a `fi` object.

The output `fi` object, `t`, has the same `numericType` properties as the leftmost `fi` object input. If the leftmost `fi` object input has a local `fi` math, the output `fi` object is assigned the same local `fi` math. Otherwise, the output `fi` object, `t`, has no local `fi` math.

See Also

Blocks

Toeplitz

Functions

`toeplitz`

Introduced before R2006a

tostring

Convert `fi`, `fimath`, `numerictype`, or `quantizer` object to string

Syntax

```
s = tostring(a)
s = tostring(F)
s = tostring(T)
s = tostring(q)
```

Description

`s = tostring(a)` converts `fi` object `a` to a character vector `s` such that `eval(s)` would create a `fi` object with the same properties as `a`.

`s = tostring(F)` converts `fimath` object `F` to a character vector `s` such that `eval(s)` would create a `fimath` object with the same properties as `F`.

`s = tostring(T)` converts `numerictype` object `T` to a character vector `s` such that `eval(s)` would create a `numerictype` object with the same properties as `T`.

`s = tostring(q)` converts `quantizer` object `q` to a character vector `s` such that `eval(s)` would create a `quantizer` object with the same properties as `q`.

Examples

Convert a `fi` Object to a String

```
a = fi(pi,1,16,10);
s = tostring(a)
a1 = eval(s)
isequal(a,a1)

s =
    'fi('numerictype',numerictype(1,16,10),'Value','3.1416015625)'
```

a1 =

```
3.1416
    DataTypeMode: Fixed-point: binary point scaling
    Signedness: Signed
    WordLength: 16
    FractionLength: 10
```

ans =

```
logical
```

1

Convert a fimath Object to a String

```
F = fimath('OverflowAction','Saturate','RoundingMethod','Convergent');
s = tostring(F)
F1 = eval(s)
isequal(F,F1)
```

s =

```
'fimath('RoundingMethod', 'Convergent',...
'OverflowAction', 'Saturate',...
'ProductMode','FullPrecision',...
'SumMode','FullPrecision')
```

F1 =

```
    RoundingMethod: Convergent
    OverflowAction: Saturate
    ProductMode: FullPrecision
    SumMode: FullPrecision
```

ans =

logical

1

Convert a numerictype Object to a String

```
T = numerictype(1,16,15);
s = tostring(T)
T1 = eval(s)
isequal(T,T1)
```

s =

```
'numerictype(1,16,15)'
```

T1 =

```
    DataTypeMode: Fixed-point: binary point scaling
    Signedness: Signed
    WordLength: 16
    FractionLength: 15
```

ans =

logical

1

Convert quantizer Object to a String

```
q = quantizer('fixed','Ceiling','Saturate',[5 4]);
s = tostring(q)
q1 = eval(s)
isequal(q,q1)

s =
    'quantizer('fixed', 'ceil', 'saturate', [5 4])'

q1 =
    DataMode = fixed
    RoundMode = ceil
    OverflowMode = saturate
    Format = [5 4]

ans =
    logical
    1
```

Input Arguments

a — Input **fi** object

fi object

Input fi object.

Data Types: fi

Complex Number Support: Yes

F — Input **fimath** object

fimath object

Input fimath object.

T — Input **numeric**type object

numeric type object

Input numeric type object.

q — Input **quantizer** object

quantizer object

Input quantizer object.

See Also

`eval` | `fi` | `fimath` | `numerictype` | `quantizer`

Introduced before R2006a

ufi

Construct unsigned fixed-point numeric object

Syntax

```
a = ufi
a = ufi(v)
a = ufi(v,w)
a = ufi(v,w,f)
a = ufi(v,w,slope,bias)
a = ufi(v,w,slopeadjustmentfactor,fixedexponent,bias)
```

Description

You can use the `ufi` constructor function in the following ways:

- `a = ufi` is the default constructor and returns an unsigned `fi` object with no value, 16-bit word length, and 15-bit fraction length.
- `a = ufi(v)` returns an unsigned fixed-point object with value `v`, 16-bit word length, and best-precision fraction length.
- `a = ufi(v,w)` returns an unsigned fixed-point object with value `v`, word length `w`, and best-precision fraction length.
- `a = ufi(v,w,f)` returns an unsigned fixed-point object with value `v`, word length `w`, and fraction length `f`.
- `a = ufi(v,w,slope,bias)` returns an unsigned fixed-point object with value `v`, word length `w`, `slope`, and `bias`.
- `a = ufi(v,w,slopeadjustmentfactor,fixedexponent,bias)` returns an unsigned fixed-point object with value `v`, word length `w`, `slopeadjustmentfactor`, `fixedexponent`, and `bias`.

`fi` objects created by the `ufi` constructor function have the following general types of properties:

- “Data Properties” on page 4-768
- “fimath Properties” on page 4-769
- “numeric type Properties” on page 4-770

These properties are described in detail in “fi Object Properties” on page 3-2 in the Properties Reference.

Note `fi` objects created by the `ufi` constructor function have no local `fimath`.

Data Properties

The data properties of a `fi` object are always writable.

- `bin` — Stored integer value of a `fi` object in binary

- `data` — Numerical real-world value of a `fi` object
- `dec` — Stored integer value of a `fi` object in decimal
- `double` — Real-world value of a `fi` object, stored as a MATLAB `double`
- `hex` — Stored integer value of a `fi` object in hexadecimal
- `int` — Stored integer value of a `fi` object, stored in a built-in MATLAB integer data type. You can also use `int8`, `int16`, `int32`, `int64`, `uint8`, `uint16`, `uint32`, and `uint64` to get the stored integer value of a `fi` object in these formats
- `oct` — Stored integer value of a `fi` object in octal

These properties are described in detail in “`fi` Object Properties” on page 3-2.

fimath Properties

When you create a `fi` object with the `ufi` constructor function, that `fi` object does not have a local `fimath` object. You can attach a `fimath` object to that `fi` object if you do not want to use the default `fimath` settings. For more information, see “`fimath` Object Construction”.

- `fimath` — fixed-point math object

The following `fimath` properties are always writable and, by transitivity, are also properties of a `fi` object.

- `CastBeforeSum` — Whether both operands are cast to the sum data type before addition

Note This property is hidden when the `SumMode` is set to `FullPrecision`.

- `OverflowAction` — Action to take on overflow
- `ProductBias` — Bias of the product data type
- `ProductFixedExponent` — Fixed exponent of the product data type
- `ProductFractionLength` — Fraction length, in bits, of the product data type
- `ProductMode` — Defines how the product data type is determined
- `ProductSlope` — Slope of the product data type
- `ProductSlopeAdjustmentFactor` — Slope adjustment factor of the product data type
- `ProductWordLength` — Word length, in bits, of the product data type
- `RoundingMethod` — Rounding method
- `SumBias` — Bias of the sum data type
- `SumFixedExponent` — Fixed exponent of the sum data type
- `SumFractionLength` — Fraction length, in bits, of the sum data type
- `SumMode` — Defines how the sum data type is determined
- `SumSlope` — Slope of the sum data type
- `SumSlopeAdjustmentFactor` — Slope adjustment factor of the sum data type
- `SumWordLength` — The word length, in bits, of the sum data type

These properties are described in detail in “`fimath` Object Properties”.

numericType Properties

When you create a `fi` object, a `numericType` object is also automatically created as a property of the `fi` object.

`numericType` — Object containing all the data type information of a `fi` object, Simulink signal or model parameter

The following `numericType` properties are, by transitivity, also properties of a `fi` object. The properties of the `numericType` object become read only after you create the `fi` object. However, you can create a copy of a `fi` object with new values specified for the `numericType` properties.

- `Bias` — Bias of a `fi` object
- `DataType` — Data type category associated with a `fi` object
- `DataTypeMode` — Data type and scaling mode of a `fi` object
- `FixedExponent` — Fixed-point exponent associated with a `fi` object
- `SlopeAdjustmentFactor` — Slope adjustment associated with a `fi` object
- `FractionLength` — Fraction length of the stored integer value of a `fi` object in bits
- `Scaling` — Fixed-point scaling mode of a `fi` object
- `Signed` — Whether a `fi` object is signed or unsigned
- `Signedness` — Whether a `fi` object is signed or unsigned

Note `numericType` objects can have a `Signedness` of `Auto`, but all `fi` objects must be `Signed` or `Unsigned`. If a `numericType` object with `Auto Signedness` is used to create a `fi` object, the `Signedness` property of the `fi` object automatically defaults to `Signed`.

- `Slope` — Slope associated with a `fi` object
- `WordLength` — Word length of the stored integer value of a `fi` object in bits

For further details on these properties, see “`numericType` Object Properties”.

Examples

Note For information about the display format of `fi` objects, refer to “View Fixed-Point Data”.

For examples of casting, see “Cast `fi` Objects”.

Example 1

For example, the following creates an unsigned `fi` object with a value of `pi`, a word length of 8 bits, and a fraction length of 3 bits:

```
a = ufi(pi,8,3)
```

```
a =
```

```
3.1250
```

```
DataTypeMode: Fixed-point: binary point scaling
```

```

Signedness: Unsigned
WordLength: 8
FractionLength: 3

```

Default `fimath` properties are associated with `a`. When a `fi` object does not have a local `fimath` object, no `fimath` object properties are displayed in its output. To determine whether a `fi` object has a local `fimath` object, use the `isfimathlocal` function.

```
isfimathlocal(a)
```

```
ans =
    0
```

A returned value of `0` means the `fi` object does not have a local `fimath` object. When the `isfimathlocal` function returns a `1`, the `fi` object has a local `fimath` object.

Example 2

The value `v` can also be an array:

```
a = ufi((magic(3)/10),16,12)
```

```
a =
```

```

0.8000    0.1001    0.6001
0.3000    0.5000    0.7000
0.3999    0.8999    0.2000

```

```

DataTypeMode: Fixed-point: binary point scaling
Signedness: Unsigned
WordLength: 16
FractionLength: 12

```

```
>>
```

Example 3

If you omit the argument `f`, it is set automatically to the best precision possible:

```
a = ufi(pi,8)
```

```
a =
```

```
3.1406
```

```

DataTypeMode: Fixed-point: binary point scaling
Signedness: Unsigned
WordLength: 8
FractionLength: 6

```

Example 4

If you omit `w` and `f`, they are set automatically to 16 bits and the best precision possible, respectively:

```
a = ufi(pi)
```

```
a =
```

```
3.1416
```

DataTypeMode: Fixed-point: binary point scaling
 Signedness: Unsigned
 WordLength: 16
 FractionLength: 14

Extended Capabilities

C/C++ Code Generation

Generate C and C++ code using MATLAB® Coder™.

Usage notes and limitations:

- All properties related to data type must be constant for code generation.

HDL Code Generation

Generate Verilog and VHDL code for FPGA and ASIC designs using HDL Coder™.

See Also

[fi](#) | [fimath](#) | [fipref](#) | [isfimathlocal](#) | [numerictype](#) | [quantizer](#) | [sfi](#)

Introduced in R2009b

uint8

Convert `fi` object to unsigned 8-bit integer

Syntax

```
c = uint8(a)
```

Description

`c = uint8(a)` returns the built-in `uint8` value of `fi` object `a`, based on its real world value. If necessary, the data is rounded-to-nearest and saturated to fit into an `uint8`.

Examples

This example shows the `uint8` values of a `fi` object.

```
a = fi([-pi 0.5 pi],0,8);  
c = uint8(a)
```

```
c =
```

```
0    1    3
```

Extended Capabilities

C/C++ Code Generation

Generate C and C++ code using MATLAB® Coder™.

HDL Code Generation

Generate Verilog and VHDL code for FPGA and ASIC designs using HDL Coder™.

See Also

[int16](#) | [int32](#) | [int64](#) | [int8](#) | [storedInteger](#) | [uint16](#) | [uint32](#) | [uint64](#)

Introduced before R2006a

uint16

Convert `fi` object to unsigned 16-bit integer

Syntax

```
c = uint16(a)
```

Description

`c = uint16(a)` returns the built-in `uint16` value of `fi` object `a`, based on its real world value. If necessary, the data is rounded-to-nearest and saturated to fit into an `uint16`.

Examples

This example shows the `uint16` values of a `fi` object.

```
a = fi([-pi 0.5 pi],0,16);  
c = uint16(a)
```

```
c =
```

```
    0     1     3
```

Extended Capabilities

C/C++ Code Generation

Generate C and C++ code using MATLAB® Coder™.

HDL Code Generation

Generate Verilog and VHDL code for FPGA and ASIC designs using HDL Coder™.

See Also

[int16](#) | [int32](#) | [int64](#) | [int8](#) | [storedInteger](#) | [uint32](#) | [uint64](#) | [uint8](#)

Introduced before R2006a

uint32

Stored integer value of `fi` object as built-in `uint32`

Syntax

```
c = uint32(a)
```

Description

`c = uint32(a)` returns the built-in `uint32` value of `fi` object `a`, based on its real world value. If necessary, the data is rounded-to-nearest and saturated to fit into an `uint32`.

Examples

This example shows the `uint32` values of a `fi` object.

```
a = fi([-pi 0.5 pi],0,32);  
c = uint32(a)
```

```
c =
```

```
0    1    3
```

Extended Capabilities

C/C++ Code Generation

Generate C and C++ code using MATLAB® Coder™.

HDL Code Generation

Generate Verilog and VHDL code for FPGA and ASIC designs using HDL Coder™.

See Also

[int16](#) | [int32](#) | [int64](#) | [int8](#) | [storedInteger](#) | [uint16](#) | [uint64](#) | [uint8](#)

Introduced before R2006a

uint64

Convert `fi` object to unsigned 64-bit integer

Syntax

```
c = uint64(a)
```

Description

`c = uint64(a)` returns the built-in `uint64` value of `fi` object `a`, based on its real world value. If necessary, the data is rounded-to-nearest and saturated to fit into an `uint64`.

Examples

This example shows the `uint64` values of a `fi` object.

```
a = fi([-pi 0.5 pi],0,64);  
c = uint64(a)
```

```
c =
```

```
0     1     3
```

Extended Capabilities

C/C++ Code Generation

Generate C and C++ code using MATLAB® Coder™.

See Also

[int16](#) | [int32](#) | [int64](#) | [int8](#) | [storedInteger](#) | [uint16](#) | [uint32](#) | [uint8](#)

Introduced in R2008b

uminus

Negate elements of `fi` object array

Syntax

```
uminus(a)
```

Description

`uminus(a)` is called for the syntax `-a` when `a` is an object. `-a` negates the elements of `a`.

`uminus` does not support `fi` objects of data type `Boolean`.

Examples

When wrap occurs, $-(-1) = -1$:

```
fipref('NumericTypeDisplay','short', ...
       'fimathDisplay','none');
format short g
a = fi(-1,true,8,7,'OverflowMode','wrap')
```

a =

```
    -1
    numerictype(1,8,7)
```

-a

ans =

```
    -1
    numerictype(1,8,7)
```

```
b = fi([-1-i -1-i],true,8,7,'OverflowMode','wrap')
```

b =

```
    -1 -      1i      -1 -      1i
    numerictype(1,8,7)
```

-b

ans =

```
    -1 -      1i      -1 -      1i
    numerictype(1,8,7)
```

b'

ans =

```
    -1 -      1i
```

```

    -1 -      1i
    numericity(1,8,7)

```

When saturation occurs, $-(-1) = 0.99\dots$:

```
c = fi(-1,true,8,7,'OverflowMode','saturate')
```

```
c =
```

```

    -1
    numericity(1,8,7)

```

```
-c
```

```
ans =
```

```

    0.99219
    numericity(1,8,7)

```

```
d = fi([-1-i -1-i],true,8,7,'OverflowMode','saturate')
```

```
d =
```

```

    -1 -      1i      -1 -      1i
    numericity(1,8,7)

```

```
-d
```

```
ans =
```

```

    0.99219 +    0.99219i    0.99219 +    0.99219i
    numericity(1,8,7)

```

```
d'
```

```
ans =
```

```

    -1 +    0.99219i
    -1 +    0.99219i
    numericity(1,8,7)

```

Extended Capabilities

C/C++ Code Generation

Generate C and C++ code using MATLAB® Coder™.

HDL Code Generation

Generate Verilog and VHDL code for FPGA and ASIC designs using HDL Coder™.

See Also

minus | mtimes | plus | times

Introduced before R2006a

unitquantize

Quantize except numbers within eps of +1

Syntax

```
y = unitquantize(q, x)
[y1,y2,...] = unitquantize(q,x1,x2,...)
```

Description

`y = unitquantize(q, x)` works the same as `quantize` except that numbers within `eps(q)` of +1 are made exactly equal to +1 .

`[y1,y2,...] = unitquantize(q,x1,x2,...)` is equivalent to `y1 = unitquantize(q,x1)`, `y2 =unitquantize(q,x2),...`

Examples

This example demonstrates the use of `unitquantize` with a quantizer object `q` and a vector `x`.

```
q = quantizer('fixed','floor','saturate',[4 3]);
x = (0.8:.1:1.2)';
y = unitquantize(q,x);
z = [x y]
e = eps(q)
```

This quantization outputs an array containing the original values of `x` and the quantized values of `x`, followed by the value of `eps(q)`:

```
z =
    0.8000    0.7500
    0.9000    1.0000
    1.0000    1.0000
    1.1000    1.0000
    1.2000    1.0000

e =
    0.1250
```

See Also

[eps](#) | [quantize](#) | [quantizer](#) | [unitquantizer](#)

Introduced in R2008a

unitquantizer

Constructor for unitquantizer object

Syntax

```
q = unitquantizer(...)
```

Description

`q = unitquantizer(...)` constructs a `unitquantizer` object, which is the same as a `quantizer` object in all respects except that its `quantize` method quantizes numbers within `eps(q)` of `+1` to exactly `+1`.

See `quantizer` for parameters.

Examples

In this example, a vector `x` is quantized by a `unitquantizer` object `u`.

```
u = unitquantizer([4 3]);  
x = (0.8:.1:1.2)';  
y = quantize(u,x);  
z = [x y]  
e = eps(u)
```

This quantization outputs an array containing the original values of `x` and the values of `x` that were quantized by the `unitquantizer` object `u`. The output also includes `e`, the value of `eps(u)`.

`z =`

```
    0.8000    0.7500  
    0.9000    1.0000  
    1.0000    1.0000  
    1.1000    1.0000  
    1.2000    1.0000
```

`e =`

```
    0.1250
```

See Also

`quantize` | `quantizer` | `unitquantize`

Introduced in R2008a

unshiftdata

Inverse of `shiftdata`

Syntax

```
y = unshiftdata(x,perm,nshifts)
```

Description

`y = unshiftdata(x,perm,nshifts)` restores the orientation of the data that was shifted with `shiftdata`. The permutation vector is given by `perm`, and `nshifts` is the number of shifts that was returned from `shiftdata`.

`unshiftdata` is meant to be used in tandem with `shiftdata`. These functions are useful for creating functions that work along a certain dimension, like `filter`, `goertzel`, `sgolayfilt`, and `sosfilt`.

Examples

Example 1

- 1 Create a 3-by-3 magic square:

```
x = fi(magic(3))
```

```
x =
```

```

     8     1     6
     3     5     7
     4     9     2

```

```

        DataTypeMode: Fixed-point: binary point scaling
        Signedness: Signed
        WordLength: 16
        FractionLength: 11

```

- 2 Shift the matrix `x` to work along the second dimension:

```
[x,perm,nshifts] = shiftdata(x,2)
```

```
x =
```

```

     8     3     4
     1     5     9
     6     7     2

```

```

        DataTypeMode: Fixed-point: binary point scaling
        Signedness: Signed
        WordLength: 16
        FractionLength: 11

```

```
perm =
```

```
      2      1
```

```
nshifts =
```

```
      []
```

This command returns the permutation vector, `perm`, and the number of shifts, `nshifts`, are returned along with the shifted matrix, `x`.

- 3 Shift the matrix back to its original shape:

```
y = unshiftdata(x,perm,nshifts)
```

```
y =
```

```
      8      1      6
      3      5      7
      4      9      2
```

```
      DataTypeMode: Fixed-point: binary point scaling
      Signedness: Signed
      WordLength: 16
      FractionLength: 11
```

Example 2

- 1 Define `x` as a row vector:

```
x = 1:5
```

```
x =
```

```
      1      2      3      4      5
```

- 2 Define `dim` as empty to shift the first non-singleton dimension of `x` to the first column:

```
[x,perm,nshifts] = shiftdata(x,[])
```

```
x =
```

```
      1
      2
      3
      4
      5
```

```
perm =
```

```
      []
```

```
nshifts =
```

```
      1
```

This command returns `x` as a column vector, along with `perm`, the permutation vector, and `nshifts`, the number of shifts.

- 3** Using `unshiftdata`, restore `x` to its original shape:

```
y = unshiftdata(x,perm,nshifts)
```

```
y =
```

```
    1    2    3    4    5
```

See Also

`shiftdata`

Introduced in R2008a

upperbound

Upper bound of range of `fi` object

Syntax

```
upperbound(a)
```

Description

`upperbound(a)` returns the upper bound of the range of `fi` object `a`. If `L = lowerbound(a)` and `U = upperbound(a)`, then `[L,U] = range(a)`.

Extended Capabilities

C/C++ Code Generation

Generate C and C++ code using MATLAB® Coder™.

HDL Code Generation

Generate Verilog and VHDL code for FPGA and ASIC designs using HDL Coder™.

See Also

`eps` | `intmax` | `intmin` | `lowerbound` | `lsb` | `range` | `realmax` | `realmin`

Introduced before R2006a

vertcat

Vertically concatenate multiple `fi` objects

Syntax

```
c = vertcat(a,b,...)
[a; b; ...]
[a;b]
```

Description

`c = vertcat(a,b,...)` is called for the syntax `[a; b; ...]` when any of `a, b, ...`, is a `fi` object.

`[a;b]` is the vertical concatenation of matrices `a` and `b`. `a` and `b` must have the same number of columns. Any number of matrices can be concatenated within one pair of brackets. N-D arrays are vertically concatenated along the first dimension. The remaining dimensions must match.

Horizontal and vertical concatenation can be combined, as in `[1 2;3 4]`.

`[a b; c]` is allowed if the number of rows of `a` equals the number of rows of `b`, and if the number of columns of `a` plus the number of columns of `b` equals the number of columns of `c`.

The matrices in a concatenation expression can themselves be formed via a concatenation, as in `[a b;[c d]]`.

Note The `fimath` and `numerictype` objects of a concatenated matrix of `fi` objects `c` are taken from the leftmost `fi` object in the list `(a,b,...)`.

Extended Capabilities

C/C++ Code Generation

Generate C and C++ code using MATLAB® Coder™.

GPU Code Generation

Generate CUDA® code for NVIDIA® GPUs using GPU Coder™.

HDL Code Generation

Generate Verilog and VHDL code for FPGA and ASIC designs using HDL Coder™.

See Also

`horzcat`

Introduced before R2006a

wordlength

Word length of quantizer object

Syntax

```
wordlength(q)
```

Description

`wordlength(q)` returns the word length of the quantizer object `q`.

Examples

```
q = quantizer([16 15]);  
wordlength(q)
```

```
ans =  
  
    16
```

See Also

`exponentlength` | `fi` | `fractionlength` | `numerictype` | `quantizer`

Introduced before R2006a

zeros

Create array of all zeros with fixed-point properties

Syntax

```
X = zeros('like',p)
X = zeros(n,'like',p)
X = zeros(sz1,...,szN,'like',p)
X = zeros(sz,'like',p)
```

Description

`X = zeros('like',p)` returns a scalar 0 with the same `numericType`, complexity (real or complex), and `fimath` as `p`.

`X = zeros(n,'like',p)` returns an `n`-by-`n` array of zeros like `p`.

`X = zeros(sz1,...,szN,'like',p)` returns an `sz1`-by-...-by-`szN` array of zeros like `p`.

`X = zeros(sz,'like',p)` returns an array of zeros like `p`. The size vector, `sz`, defines `size(X)`.

Examples

2-D Array of Zeros With Fixed-Point Attributes

Create a 2-by-3 array of zeros with specified `numericType` and `fimath` properties.

Create a signed `fi` object with word length of 24 and fraction length of 12.

```
p = fi([],1,24,12);
```

Create a 2-by-3 array of zeros that has the same `numericType` properties as `p`.

```
X = zeros(2,3,'like',p)
```

```
X=2x3 object
```

```
  0    0    0
  0    0    0
```

```
    DataTypeMode: Fixed-point: binary point scaling
    Signedness: Signed
    WordLength: 24
    FractionLength: 12
```

Size Defined by Existing Array

Define a 3-by-2 array `A`.

```
A = [1 4 ; 2 5 ; 3 6];
```

```
sz = size(A)
```

```
sz = 1×2
```

```
3 2
```

Create a signed `fi` object with word length of 24 and fraction length of 12.

```
p = fi([],1,24,12);
```

Create an array of zeros that is the same size as `A` and has the same numerictype properties as `p`.

```
X = zeros(sz, 'like', p)
```

```
X=3×2 object
```

```
0 0
0 0
0 0
```

```
DataTypeMode: Fixed-point: binary point scaling
Signedness: Signed
WordLength: 24
FractionLength: 12
```

Square Array of Zeros With Fixed-Point Attributes

Create a 4-by-4 array of zeros with specified numerictype and `fimath` properties.

Create a signed `fi` object with word length of 24 and fraction length of 12.

```
p = fi([],1,24,12);
```

Create a 4-by-4 array of zeros that has the same numerictype properties as `p`.

```
X = zeros(4, 'like', p)
```

```
X=4×4 object
```

```
0 0 0 0
0 0 0 0
0 0 0 0
0 0 0 0
```

```
DataTypeMode: Fixed-point: binary point scaling
Signedness: Signed
WordLength: 24
FractionLength: 12
```

Complex Fixed-Point Zero

Create a scalar fixed-point 0 that is not real valued, but instead is complex like an existing array.

Define a complex fi object.

```
p = fi( [1+2i 3i],1,24,12);
```

Create a scalar 1 that is complex like p.

```
X = zeros('like',p)
```

```
X =
    0.0000 + 0.0000i

    DataTypeMode: Fixed-point: binary point scaling
    Signedness: Signed
    WordLength: 24
    FractionLength: 12
```

Write MATLAB Code That Is Independent of Data Types

Write a MATLAB algorithm that you can run with different data types without changing the algorithm itself. To reuse the algorithm, define the data types separately from the algorithm.

This approach allows you to define a baseline by running the algorithm with floating-point data types. You can then test the algorithm with different fixed-point data types and compare the fixed-point behavior to the baseline without making any modifications to the original MATLAB code.

Write a MATLAB function, `my_filter`, that takes an input parameter, `T`, which is a structure that defines the data types of the coefficients and the input and output data.

```
function [y,z] = my_filter(b,a,x,z,T)
    % Cast the coefficients to the coefficient type
    b = cast(b,'like',T.coeffs);
    a = cast(a,'like',T.coeffs);
    % Create the output using zeros with the data type
    y = zeros(size(x),'like',T.data);
    for i = 1:length(x)
        y(i) = b(1)*x(i) + z(1);
        z(1) = b(2)*x(i) + z(2) - a(2) * y(i);
        z(2) = b(3)*x(i)          - a(3) * y(i);
    end
end
```

Write a MATLAB function, `zeros_ones_cast_example`, that calls `my_filter` with a floating-point step input and a fixed-point step input, and then compares the results.

```
function zeros_ones_cast_example

    % Define coefficients for a filter with specification
    % [b,a] = butter(2,0.25)
    b = [0.097631072937818    0.195262145875635    0.097631072937818];
    a = [1.0000000000000000  -0.942809041582063    0.333333333333333];
```

```

% Define floating-point types
T_float.coeffs = double([]);
T_float.data   = double([]);

% Create a step input using ones with the
% floating-point data type
t = 0:20;
x_float = ones(size(t), 'like', T_float.data);

% Initialize the states using zeros with the
% floating-point data type
z_float = zeros(1,2, 'like', T_float.data);

% Run the floating-point algorithm
y_float = my_filter(b,a,x_float,z_float,T_float);

% Define fixed-point types
T_fixed.coeffs = fi([],true,8,6);
T_fixed.data   = fi([],true,8,6);

% Create a step input using ones with the
% fixed-point data type
x_fixed = ones(size(t), 'like', T_fixed.data);

% Initialize the states using zeros with the
% fixed-point data type
z_fixed = zeros(1,2, 'like', T_fixed.data);

% Run the fixed-point algorithm
y_fixed = my_filter(b,a,x_fixed,z_fixed,T_fixed);

% Compare the results
coder.extrinsic('clf', 'subplot', 'plot', 'legend')
clf
subplot(211)
plot(t,y_float, 'co-', t,y_fixed, 'kx-')
legend('Floating-point output', 'Fixed-point output')
title('Step response')
subplot(212)
plot(t,y_float - double(y_fixed), 'rs-')
legend('Error')
figure(gcf)
end

```

Input Arguments

n — Size of square matrix

integer value

Size of square matrix, specified as an integer value, defines the output as a square, n-by-n matrix of ones.

- If n is zero, X is an empty matrix.
- If n is negative, it is treated as zero.

Data Types: double | single | int8 | int16 | int32 | int64 | uint8 | uint16 | uint32 | uint64

sz1, ..., szN — Size of each dimension

two or more integer values

Size of each dimension, specified as two or more integer values, defines X as a $sz1$ -by...-by- szN array.

- If the size of any dimension is zero, X is an empty array.
- If the size of any dimension is negative, it is treated as zero.
- If any trailing dimensions greater than two have a size of one, the output, X , does not include those dimensions.

Data Types: `double` | `single` | `int8` | `int16` | `int32` | `int64` | `uint8` | `uint16` | `uint32` | `uint64`

sz — Output size

row vector of integer values

Output size, specified as a row vector of integer values. Each element of this vector indicates the size of the corresponding dimension.

- If the size of any dimension is zero, X is an empty array.
- If the size of any dimension is negative, it is treated as zero.
- If any trailing dimensions greater than two have a size of one, the output, X , does not include those dimensions.

Example: `sz = [2,3,4]` defines X as a 2-by-3-by-4 array.

Data Types: `double` | `single` | `int8` | `int16` | `int32` | `int64` | `uint8` | `uint16` | `uint32` | `uint64`

p — Prototype`fi` object | numeric variable

Prototype, specified as a `fi` object or numeric variable. To use the prototype to specify a complex object, you must specify a value for the prototype. Otherwise, you do not need to specify a value.

Complex Number Support: Yes

Tips

Using the `b = cast(a, 'like', p)` syntax to specify data types separately from algorithm code allows you to:

- Reuse your algorithm code with different data types.
- Keep your algorithm uncluttered with data type specifications and switch statements for different data types.
- Improve readability of your algorithm code.
- Switch between fixed-point and floating-point data types to compare baselines.
- Switch between variations of fixed-point settings without changing the algorithm code.

See Also`cast` | `ones` | `zeros`**Topics**

“Implement FIR Filter Algorithm for Floating-Point and Fixed-Point Types using `cast` and `zeros`”

“Manual Fixed-Point Conversion Workflow”
“Manual Fixed-Point Conversion Best Practices”

Introduced in R2013a

Classes

coder.CellType class

Package: coder

Superclasses: coder.ArrayType

Represent set of MATLAB cell arrays

Description

Specifies the set of cell arrays that the generated code accepts. Use only with the `fiaccl -args` option. Do not pass as an input to a generated MEX function.

Construction

Note You can also create and edit `coder.Type` objects interactively by using the Coder Type Editor. See “Create and Edit Input Types by Using the Coder Type Editor”.

`t = coder.typeof(cells)` creates a `coder.CellType` object for a cell array that has the same cells and cell types as `cells`. The cells in `cells` are type objects or example values.

`t = coder.typeof(cells,sz,variable_dims)` creates a `coder.CellType` object that has upper bounds specified by `sz` and variable dimensions specified by `variable_dims`. If `sz` specifies `inf` for a dimension, then the size of the dimension is unbounded and the dimension is variable size. When `sz` is `[]`, the upper bounds do not change. If you do not specify the `variable_dims` input parameter, except for the unbounded dimensions, the dimensions of the type are fixed. A scalar `variable_dims` applies to the bounded dimensions that are not 1 or 0.

When `cells` specifies a cell array whose elements have different classes, you cannot use `coder.typeof` to create a `coder.CellType` object for a variable-size cell array.

`t = coder.newtype('cell',cells)` creates a `coder.CellType` object for a cell array that has the cells and cell types specified by `cells`. The cells in `cells` must be type objects.

`t = coder.newtype('cell',cells,sz,variable_dims)` creates a `coder.CellType` that has upper bounds specified by `sz` and variable dimensions specified by `variable_dims`. If `sz` specifies `inf` for a dimension, then the size of the dimension is unbounded and the dimension is variable size. When `sz` is `[]`, the upper bounds do not change. If you do not specify the `variable_dims` input parameter, except for the unbounded dimensions, the dimensions of the type are fixed. A scalar `variable_dims` applies to the bounded dimensions that are not 1 or 0.

When `cells` specifies a cell array whose elements have different classes, you cannot use `coder.newtype` to create a `coder.CellType` object for a variable-size cell array.

Input Arguments

cells — Specification of cell types

cell array

Cell array that specifies the cells and cell types for the output `coder.CellType` object. For `coder.typeof`, `cells` can contain type objects or example values. For `coder.newtype`, `cells` must contain type objects.

sz — Size of cell array

row vector of integer values

Specifies the upper bound for each dimension of the cell array type object. For `coder.newtype`, `sz` cannot change the number of cells for a heterogeneous cell array.

For `coder.newtype`, the default is `[1 1]`.

variable_dims — Dimensions that are variable size

row vector of logical values

Specifies whether each dimension is variable size (`true`) or fixed size (`false`).

For `coder.newtype`, the default is `true` for dimensions for which `sz` specifies an upper bound of `inf` and `false` for all other dimensions.

When `cells` specifies a cell array whose elements have different classes, you cannot create a `coder.CellType` object for a variable-size cell array.

Properties

Cells — Types of cells

cell array

A cell array that specifies the `coder.Type` of each cell.

ClassName — Name of class

character vector or string scalar

Class of values in this set.

SizeVector — Size of cell array

row vector of integer values

The upper bounds of dimensions of the cell array.

VariableDims — Dimensions that are variable size

row vector of logical values

A vector that specifies whether each dimension of the array is fixed or variable size. If a vector element is `true`, the corresponding dimension is variable size.

Methods

<code>isHeterogeneous</code>	Determine whether cell array type represents a heterogeneous cell array
<code>isHomogeneous</code>	Determine whether cell array type represents a homogeneous cell array
<code>makeHeterogeneous</code>	Make a heterogeneous copy of a cell array type
<code>makeHomogeneous</code>	Create a homogeneous copy of a cell array type

Copy Semantics

Value. To learn how value classes affect copy operations, see Copying Objects.

Examples

Create a Type for a Cell Array Whose Elements Have the Same Class

Create a type for a cell array whose first element has class `char` and whose second element has class `double`.

```
t = coder.typeof({1 2 3})
t =
coder.CellType
  1x3 homogeneous cell
  base: 1x1 double
```

The type is homogeneous.

Create a Heterogeneous Type for a Cell Array Whose Elements Have the Same Class

To create a heterogeneous type when the elements of the example cell array type have the same class, use the `makeHeterogeneous` method.

```
t = makeHeterogeneous(coder.typeof({1 2 3}))
t =
coder.CellType
  1x3 locked heterogeneous cell
  f1: 1x1 double
  f2: 1x1 double
  f3: 1x1 double
```

The cell array type is heterogeneous. It is represented as a structure in the generated code.

Create a Cell Array Type for a Cell Array Whose Elements Have Different Classes

Define variables that are example cell values.

```
a = 'a';
b = 1;
```

Pass the example cell values to `coder.typeof`.

```
t = coder.typeof({a, b})
t =
coder.CellType
```

```

1x2 heterogeneous cell
  f0: 1x1 char
  f1: 1x1 double

```

Create a Type for a Variable-Size Homogeneous Cell Array from an Example Cell Array Whose Elements Have Different Classes

Create a type for a cell array that contains two character vectors that have different sizes.

```

t = coder.typeof({'aa', 'bbb'})

t =

coder.CellType
  1x2 heterogeneous cell
    f0: 1x2 char
    f1: 1x3 char

```

The cell array type is heterogeneous.

Create a type using the same cell array input. This time, specify that the cell array type has variable-size dimensions.

```

t = coder.typeof({'aa', 'bbb'}, [1,10], [0,1])

t =

coder.CellType
  1x:10 locked homogeneous cell
    base: 1x:3 char

```

The cell array type is homogeneous. `coder.typeof` determined that the base type `1x:3 char` can represent `'aa'`, and `'bbb'`.

Create a New Cell Array Type from a Cell Array of Types

Create a type for a scalar `int8`.

```
ta = coder.newtype('int8', [1 1]);
```

Create a type for a `:1x:2` double row vector.

```
tb = coder.newtype('double', [1 2], [1 1]);
```

Create a cell array type whose cells have the types specified by `ta` and `tb`.

```

t = coder.newtype('cell', {ta, tb})

t =

coder.CellType
  1x2 heterogeneous cell

```

```
f0: 1x1 int8  
f1: :1x:2 double
```

Tips

- In the display of a `coder.CellType` object, the terms `locked heterogeneous` or `locked homogeneous` indicate that the classification as homogeneous or heterogeneous is permanent. You cannot later change the classification by using the `makeHomogeneous` or `makeHeterogeneous` methods.
- `coder.typeof` determines whether the cell array type is homogeneous or heterogeneous. If the cell array elements have the same class and size, `coder.typeof` returns a homogeneous cell array type. If the elements have different classes, `coder.typeof` returns a heterogeneous cell array type. For some cell arrays, the classification as homogeneous or heterogeneous is ambiguous. For example, the type for `{1 [2 3]}` can be a `1x2` heterogeneous type. The first element is `double` and the second element is `1x2 double`. The type can also be a `1x3` homogeneous type in which the elements have class `double` and size `1x:2`. For these ambiguous cases, `coder.typeof` uses heuristics to classify the type as homogeneous or heterogeneous. If you want a different classification, use the `makeHomogeneous` or `makeHeterogeneous` methods. The `makeHomogeneous` method makes a homogeneous copy of a type. The `makeHeterogeneous` method makes a heterogeneous copy of a type.

The `makeHomogeneous` and `makeHeterogeneous` methods permanently assign the classification as homogeneous and heterogeneous, respectively. You cannot later use one of these methods to create a copy that has a different classification.

See Also

`coder.ArrayType` | `coder.ClassType` | `coder.Constant` | `coder.EnumType` | `coder.FiType` | `coder.PrimitiveType` | `coder.StructType` | `coder.Type` | `coder.newtype` | `coder.resize` | `coder.typeof` | `fiaccel`

Topics

“Code Generation for Cell Arrays”

“Create and Edit Input Types by Using the Coder Type Editor”

Introduced in R2015b

coder.ClassType class

Package: coder

Superclasses: coder.ArrayType

Represent set of MATLAB classes

Description

Specifies the set of value class objects that the generated code can accept. Use only with the `fiaccel -args` option. Do not pass as an input to a generated MEX function.

Construction

Note You can also create and edit `coder.Type` objects interactively by using the Coder Type Editor. See “Create and Edit Input Types by Using the Coder Type Editor”.

`t = coder.typeof(value_class_object)` creates a `coder.ClassType` object for the object `value_class_object`.

`t = coder.newtype(value_class_name)` creates a `coder.ClassType` object for an object of the class `value_class_name`.

Input Arguments

value_class_object

Value class object from which to create the `coder.ClassType` object. `value_class_object` is an expression that evaluates to an object of a value class. For example:

```
v = myValueClass;
t = coder.typeof(v);

t = coder.typeof(myValueClass(2,3));
```

value_class_name

Name of a value class definition file on the MATLAB path. Specify as a character vector or string scalar. For example:

```
t = coder.newtype('myValueClass');
```

Properties

When you create a `coder.ClassType` object `t` from a value class object `v` by using `coder.typeof`, the properties of `t` are the same as the properties of `v` with the attribute `Constant` set to `false`.

Copy Semantics

Value. To learn how value classes affect copy operations, see Copying Objects.

Examples

Create Type Based on Example Object

Create a type based on an example object in the workspace.

Create a value class myRectangle.

```
classdef myRectangle
    properties
        length;
        width;
    end
    methods
        function obj = myRectangle(l,w)
            if nargin > 0
                obj.length = l;
                obj.width = w;
            end
        end
        function area = calcarea(obj)
            area = obj.length * obj.width;
        end
    end
end
```

Create a function that takes an object of myRectangle as an input.

```
function z = getarea(r)
    %#codegen
    z = calcarea(r);
end
```

Create an object of myRectangle.

```
v = myRectangle(1,2)

v =

    myRectangle with properties:

        length: 1
        width: 2
```

Create a coder.ClassType object based on v.

```
t = coder.typeof(v)

t =

    coder.ClassType
    1x1 myRectangle
        length: 1x1 double
        width : 1x1 double
```

coder.typeof creates a coder.ClassType object that has the same properties names and types as v has.

Generate code for `getarea`. Specify the input type by passing the `coder.ClassType` object, `t`, to the `-args` option.

```
codegen getarea -args {t} -report
```

Create Type by Using `coder.newtype`

Create a `coder.ClassType` object for an object of the value class `mySquare` by using `coder.newtype`.

Create value class `mySquare` that has one property, `side`.

```
classdef mySquare
    properties
        side;
    end
    methods
        function obj = mySquare(val)
            if nargin > 0
                obj.side = val;
            end
        end
        function a = calcarea(obj)
            a = obj.side * obj.side;
        end
    end
end
```

Create a `coder.ClassType` type for `mySquare`.

```
t = coder.newtype('mySquare')
```

The previous step creates a `coder.ClassType` type for `t`, but does not assign any properties of `mySquare` to it. To ensure `t` has all the properties of `mySquare`, specify the type of `side` by using `t.Properties`.

```
t.Properties.side = coder.typeof(2)
```

Tips

- After you create a `coder.ClassType`, you can modify the types of the properties. For example:

```
t = coder.typeof(myClass)
t.Properties.prop1 = coder.typeof(int16(2));
t.Properties.prop2 = coder.typeof([1 2 3]);
```

- After you create a `coder.ClassType`, you can add properties. For example:

```
t = coder.typeof(myClass)
t.Properties.newprop1 = coder.typeof(int8(2));
t.Properties.newprop2 = coder.typeof([1 2 3]);
```

- When you generate code, the properties of the `coder.ClassType` object that you pass to `codegen` must be consistent with the properties in the class definition file. However, if the class definition file has properties that your code does not use, the `coder.ClassType` object does not have to include those properties. The code generator removes properties that you do not use.

See Also

`coder.ArrayType` | `coder.CellType` | `coder.Constant` | `coder.EnumType` | `coder.FiType` | `coder.PrimitiveType` | `coder.Type` | `coder.newtype` | `coder.resize` | `coder.typeof` | `fiaccel`

Topics

“Create and Edit Input Types by Using the Coder Type Editor”

Introduced in R2017a

coder.mexconfig

Package: coder

Code acceleration configuration object for use with `fiaccl`

Description

A `coder.mexconfig` object contains all the configuration parameters that the `fiaccl` function uses when accelerating fixed-point code via a generated MEX function. To use this object, first create it using the lowercase `coder.mexconfig` function and then, pass it to the `fiaccl` function using the `-config` option.

Construction

`cfg = coder.mexconfig` creates a `coder.mexconfig` object, `cfg`, for `fiaccl` MEX function generation.

Properties

CompileTimeRecursionLimit

For compile-time recursion, control the number of copies of a function that are allowed in the generated code. To disallow recursion in the MATLAB code, set `CompileTimeRecursionLimit` to 0. The default compile-time recursion limit is high enough for most recursive functions that require compile-time recursion. If code generation fails because of the compile-time recursion limit, and you want compile-time recursion, try to increase the limit. Alternatively, change your MATLAB code so that the code generator uses run-time recursion

Default: *integer*, 50

ConstantFoldingTimeout

Maximum number of constant folder instructions

Specify, as a positive integer, the maximum number of instructions to be executed by the constant folder.

Default: 10000

DynamicMemoryAllocation

Dynamic memory allocation for variable-size data

By default, when this property is set to `'Threshold'`, dynamic memory allocation is enabled for all variable-size arrays whose size is greater than `DynamicMemoryAllocationThreshold` and `fiaccl` allocates memory for this variable-size data dynamically on the heap. Set this property to `'Off'` to allocate memory statically on the stack. Set it to `'AllVariableSizeArrays'` to allocate memory for all variable-size arrays dynamically on the heap. You must use dynamic memory allocation for all unbounded variable-size data.

This property, `DynamicMemoryAllocation`, is enabled only when `EnableVariableSizing` is `true`. When you set `DynamicMemoryAllocation` to `'Threshold'`, it enables the `DynamicMemoryAllocationThreshold` property.

Default: `Threshold`

DynamicMemoryAllocationThreshold

Memory allocation threshold

Specify the integer size of the threshold for variable-size arrays above which `fiaccl` allocates memory on the heap.

Default: `65536`

EnableAutoExtrinsicCalls

Specify whether `fiaccl` treats common visualization functions as extrinsic functions. When this option is enabled, `fiaccl` detects calls to many common visualization functions, such as `plot`, `disp`, and `figure`. It calls out to MATLAB for these functions. This capability reduces the amount of time that you spend making your code suitable for code generation. It also removes the requirement to declare these functions extrinsic using the `coder.extrinsic` function.

Default: `true`

EchoExpressions

Show results of code not terminated with semicolons

Set this property to `true` to have the results of code instructions that do not terminate with a semicolon appear in the MATLAB Command Window. If you set this property to `false`, code results do not appear in the MATLAB Command Window.

Default: `true`

EnableRuntimeRecursion

Allow recursive functions in the generated code. If your MATLAB code requires run-time recursion and this parameter is `false`, code generation fails.

Default: `true`

EnableDebugging

Compile generated code in debug mode

Set this property to `true` to compile the generated code in debug mode. Set this property to `false` to compile the code in normal mode.

Default: `false`

EnableVariableSizing

Variable-sized arrays support

Set this property to `true` to enable support for variable-sized arrays and to enable the `DynamicMemoryAllocation` property. If you set this property to `false`, variable-sized arrays are not supported.

Default: `true`

ExtrinsicCalls

Extrinsic function calls

An extrinsic function is a function on the MATLAB path that the generated code dispatches to MATLAB software for execution. `fiaccl` does not compile or generate code for extrinsic functions. Set this property to `true` to have `fiaccl` generate code for the call to a MATLAB function, but not generate the function's internal code. Set this property to `false` to have `fiaccl` ignore the extrinsic function and not generate code for the call to the MATLAB function. If the extrinsic function affects the output of `fiaccl`, a compiler error occurs.

`ExtrinsicCalls` affects how MEX functions built by `fiaccl` generate random numbers when using the MATLAB `rand`, `randi`, and `randn` functions. If extrinsic calls are enabled, the generated mex function uses the MATLAB global random number stream to generate random numbers. If extrinsic calls are not enabled, the MEX function built with `fiaccl` uses a self-contained random number generator.

If you disable extrinsic calls, the generated MEX function cannot display run-time messages from `error` or `assert` statements in your MATLAB code. The MEX function reports that it cannot display the error message. To see the error message, enable extrinsic function calls and generate the MEX function again.

Default: `true`

GenerateReport

Code generation report

Set this property to `true` to create an HTML code generation report. Set this property to `false` to not create the report.

Default: `false`

GlobalDataSyncMethod

MEX function global data synchronization with MATLAB global workspace

Set this property to `SyncAlways` so synchronize global data at MEX function entry and exit and for all extrinsic calls to ensure maximum consistency between MATLAB and the generated MEX function. If the extrinsic calls do not affect global data, use this option in conjunction with the `coder.extrinsic -sync:off` option to turn off synchronization for these calls to maximize performance.

If you set this property to `SyncAtEntryAndExits`, global data is synchronized only at MEX function entry and exit. If your code contains extrinsic calls, but only a few affect global data, use this option in conjunction with the `coder.extrinsic -sync:on` option to turn on synchronization for these calls to maximize performance.

If you set this property to `NoSync`, no synchronization occurs. Ensure that your MEX function does not interact with MATLAB globals before disabling synchronization otherwise inconsistencies between MATLAB and the MEX function might occur.

Default: `SyncAlways`

InlineStackLimit

Stack size for inlined functions

Specify, as a positive integer, the stack size limit on inlined functions.

Default: `4000`

InlineThreshold

Maximum size of functions to be inlined

Specify, as a positive integer, the maximum size of functions to be inlined.

Default: `10`

InlineThresholdMax

Maximum size of functions after inlining

Specify, as a positive integer, the maximum size of functions after inlining.

Default: `200`

IntegrityChecks

Memory integrity

Set this property to `true` to detect any violations of memory integrity in code generated for MATLAB. When a violation is detected, execution stops and a diagnostic message displays. Set this property to `false` to disable both memory integrity checks and the runtime stack.

Default: `true`

LaunchReport

Code generation report display

Set this property to `true` to open the HTML code generation report automatically when code generation completes. Set this property to `false` to disable displaying the report automatically. This property applies only if you set the `GenerateReport` property to `true`.

Default: `true`

ReportPotentialDifferences

Specify whether to report potential behavior differences between generated code and MATLAB code. If `ReportPotentialDifferences` is `true`, the code generation report has a tab that lists the potential differences. A potential difference is a difference that occurs at run time only under certain conditions.

Default: true

ResponsivenessChecks

Responsiveness checks

Set this property to `true` to turn on responsiveness checks. Set this property to `false` to disable responsiveness checks.

Default: true

SaturateOnIntegerOverflow

Integer overflow action

Overflows saturate to either the minimum or maximum value that the data type can represent. Set this property to `true` to have overflows saturate. Set this property to `false` to have overflows wrap to the appropriate value representable by the data type.

Default: true

StackUsageMax

Maximum stack usage per application

Specify, as a positive integer, the maximum stack usage per application in bytes. Set a limit that is lower than the available stack size. Otherwise, a runtime stack overflow might occur. Overflows are detected and reported by the C compiler, not by `fiaccel`.

Default: 200000

Copy Semantics

Handle. To learn how handle classes affect copy operations, see [Copying Objects](#).

Examples

Use the lowercase `coder.mexconfig` function to create a `coder.mexconfig` configuration object. Set this object to disable run-time checks.

```
cfg = coder.mexconfig
% Turn off Integrity Checks, Extrinsic Calls,
% and Responsiveness Checks
cfg.IntegrityChecks = false;
cfg.ExtrinsicCalls = false;
cfg.ResponsivenessChecks = false;
% Use fiaccel to generate a MEX function for file foo.m
fiaccel -config cfg foo
```

See Also

`coder.ArrayType` | `coder.Constant` | `coder.EnumType` | `coder.FiType` |
`coder.PrimitiveType` | `coder.StructType` | `coder.Type` | `coder.mexconfig` |
`coder.newtype` | `coder.resize` | `coder.typeof` | `fiaccel`

coder.SingleConfig class

Package: coder

Double-precision to single-precision conversion configuration object

Description

A `coder.SingleConfig` object contains the configuration parameters that the `convertToSingle` function requires to convert double-precision MATLAB code to single-precision MATLAB code. To pass this object to the `convertToSingle` function, use the `-config` option.

Construction

`scfg = coder.config('single')` creates a `coder.SingleConfig` object for double-precision to single-precision conversion.

Properties

OutputFileNameSuffix — Suffix for single-precision file name

'_single' (default) | character vector

Suffix that the single-conversion process uses for generated single-precision files.

LogIOForComparisonPlotting — Enable simulation data logging for comparison plotting of input and output variables

false (default) | true

Enable simulation data logging to plot the data differences introduced by single-precision conversion.

PlotFunction — Name of function for comparison plots

' ' (default) | character vector

Name of function to use for comparison plots.

To enable comparison plotting, set `LogIOForComparisonPlotting` to true. This option takes precedence over `PlotWithSimulationDataInspector`.

The plot function must accept three inputs:

- A structure that holds the name of the variable and the function that uses it.
- A cell array to hold the logged floating-point values for the variable.
- A cell array to hold the logged values for the variable after fixed-point conversion.

PlotWithSimulationDataInspector — Specify use of Simulation Data Inspector for comparison plots

false (default) | true

Use Simulation Data Inspector for comparison plots.

LogIOForComparisonPlotting must be set to true to enable comparison plotting. The PlotFunction option takes precedence over PlotWithSimulationDataInspector.

TestBenchName — Name of test file

' ' (default) | character vector | cell array of character vectors

Test file name or names, specified as a character vector or cell array of character vectors. Specify at least one test file.

If you do not explicitly specify input parameter data types, the conversion uses the first file to infer these data types.

TestNumerics — Enable numerics testing

false (default) | true

Enable numerics testing to verify the generated single-precision code. The test file runs the single-precision code.

Methods

addFunctionReplacement Replace double-precision function with single-precision function during single-precision conversion

Examples

Generate Single-Precision MATLAB Code

Create a coder.SingleConfig object.

```
scfg= coder.config('single');
```

Set the properties of the doubles-to-singles configuration object. Specify the test file. In this example, the name of the test file is myfunction_test. The conversion process uses the test file to infer input data types and collect simulation range data. Enable numerics testing and generation of comparison plots.

```
scfg.TestBenchName = 'myfunction_test';
scfg.TestNumerics = true;
scfg.LogIOForComparisonPlotting = true;
```

Run convertToSingle. Use the -config option to specify the coder.SingleConfig object that you want to use. In this example, the MATLAB function name is myfunction.

```
convertToSingle -config scfg myfunction
```

See Also

coder.config | convertToSingle

Topics

“Generate Single-Precision MATLAB Code”

Introduced in R2015b

DataTypeWorkflow.Converter

Create fixed-point converter object

Description

The `DataTypeWorkflow.Converter` object contains the object functions and parameters needed to collect simulation and derived data, propose and apply data types to the model, and analyze results. Use the `DataTypeWorkflow.Converter` object to perform the same fixed-point conversion tasks as the Fixed-Point Tool.

Creation

Syntax

```
converter = DataTypeWorkflow.Converter(systemToScale)
converter = DataTypeWorkflow.Converter(referencedModelSystem, 'TopModel',
topModel)
```

Description

`converter = DataTypeWorkflow.Converter(systemToScale)` creates a converter object for the `systemToScale`.

`converter = DataTypeWorkflow.Converter(referencedModelSystem, 'TopModel', topModel)` creates a converter object with the specified referenced model, `referencedModelSystem`, as the system to scale.

Input Arguments

systemToScale — Name of model or system to scale

character vector

Name of the model or subsystem to scale, specified as a character vector.

Example: `converter = DataTypeWorkflow.Converter('ex_fixed_point_workflow');`

referencedModelSystem — Name of referenced model or system inside a referenced model

character vector

Name of the referenced model or the subsystem within a referenced model to convert to fixed point, specified as a character vector.

topModel — Name of top-level model

character vector

Name of the top-level model that references `referencedModelSystem`, specified as a character vector. `topModel` is used during the range collection phase of conversion.

Properties

CurrentRunName — Current run in the converter object

character vector

Current run stored in the converter object, specified as a character vector.

Example: `converter.CurrentRunName = 'FixedPointRun'`

Data Types: char

RunNames — Names of all runs

cell array of character vectors

Names of all runs stored in the converter object, specified as a cell array of character vectors.

Example: `converter.RunNames`

Data Types: cell

SelectedSystemToScale — Name of model or subsystem

character vector

Name of the model or subsystem to scale, returned as a character vector.

Example: `converter.SelectedSystemToScale`

Data Types: char

ShortcutsForSelectedSystem — Available system shortcuts

cell array of character vectors

Available system settings shortcuts for the selected subsystem, specified as a cell array of character vectors.

Example: `converter.ShortcutsForSelectedSystem`

Data Types: cell

TopModel — Name of top-level model

character vector

Name of the top-level model that references `referencedModelSystem`, specified as a character vector. `topModel` is used during the range collection phase of conversion.

Example: `converter.TopModel`

Data Types: char

Object Functions

<code>applyDataTypes</code>	Apply proposed data types to model
<code>applySettingsFromRun</code>	Apply system settings used in previous run to model
<code>applySettingsFromShortcut</code>	Apply settings from shortcut to model
<code>deriveMinMax</code>	Derive range information for model
<code>proposalIssues</code>	Get results which have comments associated with them
<code>proposeDataTypes</code>	Propose data types for system
<code>results</code>	Find results for selected system in converter object

saturationOverflows	Get results where saturation occurred
simulateSystem	Simulate system specified by converter object
verify	Compare behavior of baseline and autoscaled systems
wrapOverflows	Get results where wrapping occurred

Examples

Create a DataTypeWorkflow.Converter Object

This example shows how to create a DataTypeWorkflow.Converter object.

Open the fxdemo_feedback model.

```
open_system('fxdemo_feedback');
```

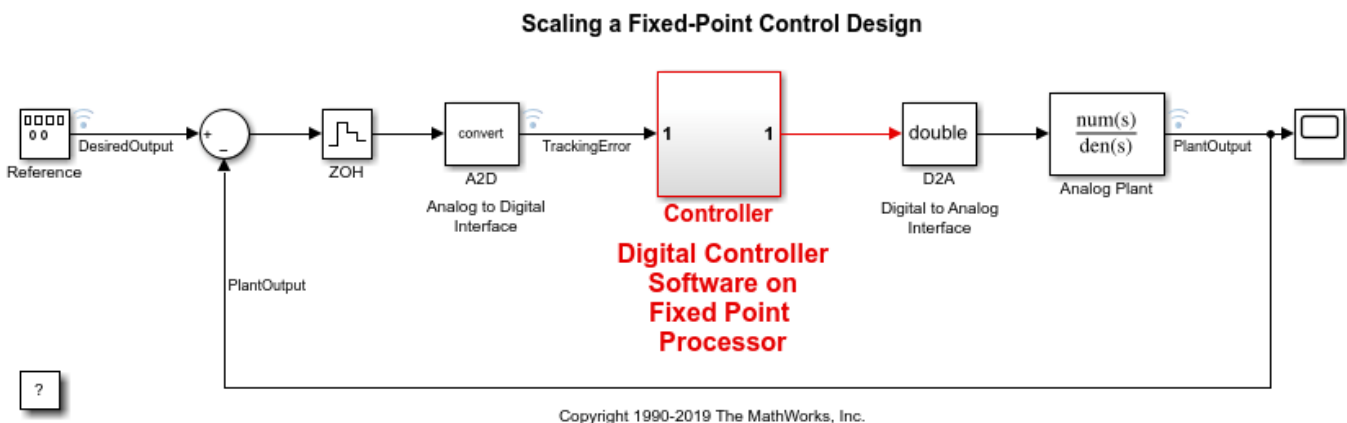

The Controller subsystem uses fixed-point data types. Create a DataTypeWorkflow.Converter object.

```
converter = DataTypeWorkflow.Converter('fxdemo_feedback/Controller');
```

You can view and edit properties of the converter object from the command line. For example, to change the name of the current run:

```
converter.CurrentRunName = 'FixedPointRun'
```

```
converter =
```

Converter with properties:

```

CurrentRunName: 'FixedPointRun'
RunNames: {0x1 cell}
ShortcutsForSelectedSystem: {6x1 cell}
TopModel: 'fxdemo_feedback'
```

```
SelectedSystemToScale: 'fxpdemo_feedback/Controller'
```

See Also

Fixed-Point Tool | `DataTypeWorkflow.ProposalSettings`

Topics

“Convert a Model to Fixed Point Using the Command Line”

“The Command-Line Interface for the Fixed-Point Tool”

Introduced in R2014b

DataTypeWorkflow.ProposalSettings

Proposal settings object for data type proposals

Description

The `DataTypeWorkflow.ProposalSettings` object manages the properties related to how data types are proposed for a model, including the default floating point data type, and safety margins for the proposed data types.

Creation

Syntax

```
propSettings = DataTypeWorkflow.ProposalSettings
```

Description

`propSettings = DataTypeWorkflow.ProposalSettings` creates a proposal settings object.

Properties

DefaultWordLength — Default word length for floating-point signals

16 (default) | scalar

Default word length for floating-point signals, specified as a scalar. Use this setting when the `ProposeFractionLength` property is set to `true`.

Example: `propSettings.DefaultWordLength = 16`

Data Types: `double`

DefaultFractionLength — Default fraction length for floating-point signals

4 (default) | scalar

Default fraction length for floating-point signals, specified as a scalar. Use this setting when the `ProposeWordLength` property is set to `true`.

Example: `propSettings.DefaultFractionLength = 4`

Data Types: `double`

ProposeFractionLength — Whether to propose fraction lengths for specified word length

`true` (default) | `false`

Whether to propose fraction lengths for the default word length specified in the `DefaultWordLength` property, specified as a Boolean. Setting this property to `true` automatically sets the `ProposeWordLength` property to `false`.

Example: `propSettings.ProposeFractionLength = logical(true)`

Data Types: `logical`

ProposeForInherited — Whether to propose fixed-point data types for objects with an inherited output data type

`true` (default) | `false`

Whether to propose fixed-point data types for objects in the system with inherited output data types, specified as a Boolean.

Example: `propSettings.ProposeForInherited = logical(true)`

Data Types: `logical`

ProposeForFloatingPoint — Whether to propose fixed-point data types for objects with a floating-point output data type

`true` (default) | `false`

Whether to propose fixed-point data types for objects in the system with floating-point output data types, specified as a Boolean.

Example: `propSettings.ProposeForFloatingPoint = logical(true)`

Data Types: `logical`

ProposeSignedness — Whether to propose signedness for objects in the system

`true` (default) | `false`

Whether to propose signedness for objects in the system, specified as a Boolean.

The software bases the signedness proposal on collected range information and block constraints. Signals that are always strictly positive are assigned an unsigned data type proposal, and gain an additional bit of precision. If you set this property to `false`, the software proposes a signed data type for all results that currently specify a floating-point or an inherited output data type unless other constraints are present. If a result specifies a fixed-point output data type, the software will propose a data type with the same signedness as the currently specified data type unless other constraints are present.

Example: `propSettings.ProposeForFloatingPoint = logical(true)`

Data Types: `logical`

ProposeWordLength — Whether to propose word lengths for specified default fraction lengths

`false` (default) | `true`

Whether to propose word lengths for the default fraction length in the `DefaultFractionLength` property, specified as a Boolean. Setting this property to `true` automatically sets the `ProposeFractionLength` property to `false`.

Example: `propSettings.ProposeWordLength = logical(false)`

Data Types: `logical`

SafetyMargin — Safety margin for simulation minimum and maximum values

0 (default) | scalar

Safety margin for simulation minimum and maximum values, specified as a scalar.

The simulation minimum and maximum values are adjusted by the percentage designated by this parameter. This parameter allows you to specify a range different from that obtained from the simulation run.

For example, a value of 55 specifies that a range at least 55 percent larger is desired. A value of -15 specifies that a range of up to 15 percent smaller is acceptable.

Example: `propSettings.SafetyMargin = 55`

Data Types: `double`

UseDerivedMinMax — Whether to use derived ranges to propose data types

`true (default) | false`

Whether to use derived ranges for data type proposals, specified as a Boolean.

Example: `propSettings.UseDerivedMinMax = logical(true)`

Data Types: `logical`

UseSimMinMax — Whether to use simulation ranges to propose data types

`true (default) | false`

Whether to use simulation ranges for data type proposals, specified as a Boolean.

Example: `propSettings.UseSimMinMax = logical(true)`

Data Types: `logical`

Object Functions

<code>addTolerance</code>	Specify numeric tolerance for converted system
<code>clearTolerances</code>	Clear all tolerances specified by a <code>DataTypeWorkflow.ProposalSettings</code> object
<code>showTolerances</code>	Show tolerances specified for a system

Alternatives

The properties of the `DataTypeWorkflow.ProposalSettings` object can also be controlled from the **Settings** menu in the Fixed-Point Tool. For more information, see [Fixed-Point Tool](#).

See Also

`DataTypeWorkflow.Converter`

Topics

“Convert a Model to Fixed Point Using the Command Line”

Introduced in R2014b

DataTypeWorkflow.Result

Object containing run result information

Description

The `DataTypeWorkflow.Result` object manages the results of simulation, derivation, and data type proposals.

Creation

The `results` function returns a handle to a `DataTypeWorkflow.Result` object.

Properties

Comments — Comments associated with the signal

cell array of character vectors

Comments associated with the signal, specified as a cell array of character vectors.

Example: `results.Comments`

Data Types: `cell`

CompiledDataType — Data type used during simulation

character vector

Data type used during simulation, specified as a character vector.

Example: `results.CompiledDataType`

Data Types: `char`

DerivedMax — Derived maximum value

scalar

Derived maximum value for the signal or internal data based on specified design maximums, specified as a scalar.

Use the `DataTypeWorkflow.ProposalSettings` object and related object functions to specify and manage numeric tolerances for signals.

Example: `results.DerivedMax`

Data Types: `double`

DerivedMin — Derived minimum value

scalar

Derived minimum value for the signal or internal data based on specified design minimums, specified as a scalar.

Use the `DataTypeWorkflow.ProposalSettings` object and related object functions to specify and manage numeric tolerances for signals.

Example: `results.DerivedMin`

Data Types: `double`

DesignMax — Design maximum value

scalar

Design maximum value for the signal or internal data, specified as a scalar.

Example: `results.DesignMax`

Data Types: `double`

DesignMin — Design minimum value

scalar

Design minimum value for the signal or internal data, specified as a scalar.

Example: `results.DesignMin`

Data Types: `double`

ProposedDataType — Proposed data type

character vector

Proposed data type for the signal or internal data type associated with this result, specified as a character vector.

Example: `results.ProposedDataType`

Data Types: `char`

ResultName — Name of signal

character vector

Name of the signal or internal data associated with this result, specified as a character vector.

Example: `results.ResultName`

Data Types: `char`

RunName — Name of run associated with result

character vector

Name of the run associated with the result, specified as a character vector.

Example: `results.RunName`

Data Types: `char`

Saturations — Number of saturations that occurred

scalar

Number of saturations that occurred, specified as a scalar.

The number of occurrences where the signal or internal data associated with this result saturated at the maximum or minimum of its specified data type. The value of this property is the cumulative total of all of the run executions for this result.

Example: `results.Saturations`

Data Types: `double`

SimMax — Simulation maximum

scalar

Simulation maximum, specified as a scalar. This property represents the values obtained for the signal or internal data during all of the saved executions of the run this result is associated with.

Example: `results.SimMax`

Data Types: `double`

SimMin — Simulation minimum

scalar

Simulation minimum, specified as a scalar. This property represents the value obtained for the signal or internal data during all of the saved executions of the run this result is associated with.

Example: `results.SimMin`

Data Types: `double`

SpecifiedDataType — Specified data type of signal

character vector

Specified data type of the signal, specified as a character vector. This property takes effect the next time the system is run.

Example: `results.SpecifiedDataType`

Data Types: `char`

Wraps — Number of wraps that occurred

scalar

Number of wraps that occurred, specified as a scalar.

The number of occurrences where the signal or internal data associated with this result wrapped around the maximum or minimum of its specified data type. The value of this property is the cumulative total of all of the run executions for this result.

Example: `results.Wraps`

Data Types: `double`

See Also

`DataTypeWorkflow.Converter` | `DataTypeWorkflow.ProposalSettings` | `results`

Topics

“Convert a Model to Fixed Point Using the Command Line”

Introduced in R2014b

DataTypeWorkflow.VerificationResult

Verification results after converting a system to fixed point

Description

A `DataTypeWorkflow.VerificationResult` object contains the results after converting a system to fixed point. The verification result object indicates whether a conversion was successful based on the tolerances specified on the `DataTypeWorkflow.ProposalSettings` object used during the conversion.

Creation

Syntax

```
verificationResult = verify(converter, BaselineRunName, RunName)
```

Description

`verificationResult = verify(converter, BaselineRunName, RunName)` simulates the system specified by the `DataTypeWorkflow.Converter` object, `converter`, and stores the run information in a new run, `RunName`. It returns a `DataTypeWorkflow.VerificationResult` object that compares the baseline and verification runs.

The `DataTypeWorkflow.Converter` object contains instrumentation data from the run specified by `BaselineRunName`, as well as the tolerances specified on the associated `DataTypeWorkflow.ProposalSettings` object. The software determines if the behavior of the verification run is acceptable using the tolerances specified by the `ProposalSettings` object.

Properties

RunName — Name of verification run to create

character vector

Name of the verification run to create during the embedded simulation, specified as a character vector.

Example: `verificationResult.RunName`

Data Types: char

BaselineRunName — Baseline run to compare against

character vector

Baseline run to compare against, specified as a character vector.

Example: `verificationResult.BaselineRunName`

Data Types: char

Status — Whether the verification run meets the specified tolerances

Pass | Warn | Fail

Whether the verification run meets the specified tolerances, returned as either `Pass`, `Warn`, or `Fail`. For additional details, use `explore` to display logged data in the Simulation Data Inspector.

Status	Description
Pass	All signals with a specified tolerance on the associated <code>ProposalSettings</code> object are within the specified tolerances in the verification run.
Fail	One or more signals with a specified tolerance on the associated <code>ProposalSettings</code> object are not within the specified tolerances in the verification run.

Example: `verificationResult.Status`

Data Types: `char`

Object Functions

`explore` Explore comparison of baseline and fixed-point implementations

See Also

`DataTypeWorkflow.Converter` | `DataTypeWorkflow.ProposalSettings`

Topics

“Convert a Model to Fixed Point Using the Command Line”

Introduced in R2019a

fixed.DataGenerator

Creates value set and generates data

Description

Use the `fixed.DataSpecification` and `fixed.DataGenerator` objects to generate simulation inputs to test the full operating range of your designs.

Creation

Syntax

```
data = fixed.DataGenerator(Name, Value)
```

Description

`data = fixed.DataGenerator(Name, Value)` creates a `DataGenerator` object with additional properties specified as `Name, Value` pair arguments.

Properties

DataSpecifications — Properties of generated data

`fixed.DataSpecification` object | cell array of `fixed.DataSpecification` objects

Properties of the data to generate, specified as a `fixed.DataSpecification` object.

Specifying a cell array of `DataSpecification` objects produces a single `DataGenerator` object for input to a system with the same number of inputs and in the same order as elements in the cell array.

NumDataPointsLimit — Maximum number of data points in generated data

100000 (default) | integer-valued scalar

Maximum number of data points in generated data, specified as an integer-valued scalar. For more information, see `getNumDataPointsInfo`.

Data Types: `single` | `double` | `int8` | `int16` | `int32` | `int64` | `uint8` | `uint16` | `uint32` | `uint64`

Object Functions

<code>getUniqueValues</code>	Get unique values from <code>fixed.DataGenerator</code> object
<code>getNumDataPointsInfo</code>	Get information about number of data points in generated data
<code>outputAllData</code>	Get data from <code>fixed.DataGenerator</code> object

Examples

Create a fixed.DataGenerator object

Create a `DataGenerator` object by specifying a `DataSpecification` object in the constructor.

Create the `DataSpecification` object with an interval from -2π to 2π with a data type of `single`.

```
dataspec = fixed.DataSpecification('single', 'Intervals', {-2*pi, 2*pi})
```

```
dataspec =
    fixed.DataSpecification with properties:
```

```
        DataTypeStr: 'single'
        Intervals: [-6.2832,6.2832]
    ExcludeDenormals: false
    ExcludeNegativeZero: false
    MandatoryValues: <empty>
        Complexity: 'real'
        Dimensions: 1
```

Use the `DataSpecification` object to create a `DataGenerator` object. Limit the number of data points in the generated data to 5000 points. You can specify these properties as name-value pairs in the constructor of the `DataGenerator` object.

```
datagen = fixed.DataGenerator('DataSpecifications', dataspec, 'NumDataPointsLimit', 5000)
```

```
datagen =
    fixed.DataGenerator with properties:
```

```
        DataSpecifications: {[1x1 fixed.DataSpecification]}
        NumDataPointsLimit: 5000
```

Use the `outputAllData` function to see the generated data.

```
myData = outputAllData(datagen)
```

```
myData = 1x262 single row vector
```

```
-6.2832   -6.2832   -4.0000   -4.0000   -4.0000   -2.0000   -2.0000   -2.0000   -1.0000   -1.0000
```

Algorithms**Data Generation for One-Dimensional, Two-Dimensional, and Complex Data**

When you use a `DataGenerator` object to generate data for a `DataSpecification` object with the `Dimensions` property set to 1, the output data always contains the minimum and maximum values of the specified intervals, and any values specified by the `MandatoryValues` property.

When you generate data for a `DataSpecification` object with the `Dimensions` property set to a value greater than 1, the output is generated by taking a cartesian product of the one-dimensional output.

For example, consider the following two `DataSpecification` objects. The two objects are identical except that one is one-dimensional, and the other is two-dimensional.

```

dataspec_1d = fixed.DataSpecification('single',...
  'Intervals', {-1,1}, 'Dimensions',1);
dataspec_2d = fixed.DataSpecification('single',...
  'Intervals', {-1,1}, 'Dimensions',2);

```

Create two DataGenerator objects based on these specifications. Set the maximum number of data points in the generated data to inf.

```

datagen_1d = fixed.DataGenerator('DataSpecifications', ...
  dataspec_1d, 'NumDataPointsLimit', inf);
datagen_2d = fixed.DataGenerator('DataSpecifications', ...
  dataspec_2d, 'NumDataPointsLimit', inf);

```

Get the size of the generated data for each of the configurations.

```

size_1d_data = size(outputAllData(datagen_1d))
size_2d_data = size(outputAllData(datagen_2d))

```

```

size_1d_data =

```

```

    1    244

```

```

size_2d_data =

```

```

     2    59536

```

The length of the two-dimensional data is exactly the squared length of the one-dimensional data.

The DataGenerator generates complex data in a similar way to the two-dimensional data. Create a DataSpecification object with Dimensions set to 1 and the Complexity set to complex. Create a DataGenerator object using this specification.

```

dataspec_complex = fixed.DataSpecification('single', ...
  'Intervals', {-1,1}, 'Dimensions', 1, 'Complexity', 'complex');

```

```

datagen_complex = fixed.DataGenerator('DataSpecifications', ...
  dataspec_complex, 'NumDataPointsLimit', inf);

```

Get the size of the generated data from this configuration.

```

size_complex_data = size(outputAllData(datagen_complex))

```

```

size_complex_data =

```

```

    1    59536

```

The length of the output data for the one-dimensional complex data is the same as the length of the two-dimensional real data.

See Also

Objects

fixed.DataSpecification | fixed.Interval

Introduced in R2019b

fixed.DataSpecification

Specify properties of data to generate

Description

Use the `fixed.DataSpecification` and `fixed.DataGenerator` objects to generate simulation inputs to test the full operating range of your designs.

Creation

Syntax

```
dataspec = fixed.DataSpecification(numerictype)
dataspec = fixed.DataSpecification(numerictype, Name, Value)
```

Description

`dataspec = fixed.DataSpecification(numerictype)` creates a `DataSpecification` object with default property values and data type specified by `numerictype`.

`dataspec = fixed.DataSpecification(numerictype, Name, Value)` creates a `DataSpecification` object with data type specified by `numerictype`, and additional properties specified as `Name, Value` pair arguments.

Input Arguments

numerictype — Data type of generated data

character vector | `Simulink.NumericType` object | `embedded.numerictype` object

Data type of the generated data, specified as a string or character vector that evaluates to a numeric data type, or as a `Simulink.NumericType` or `numerictype` object.

Example: `dataspec = fixed.DataSpecification('double')`

Example: `dataspec = fixed.DataSpecification('fixdt(1,16,4)')`

Example: `dataspec = fixed.DataSpecification(Simulink.NumericType);`

Properties

DataTypeStr — Data type of generated data

character vector | `Simulink.NumericType` object | `embedded.numerictype` object

Data type of the generated data, specified as a string or character vector that evaluates to a numeric data type, or as a `Simulink.NumericType` or `numerictype` object.

This property cannot be edited after construction.

Intervals — Intervals within which to generate numeric data

`fixed.Interval` object | array of `fixed.Interval` objects | cell array containing inputs to `fixed.Interval` constructor

Numeric intervals in which to generate numeric data, specified as a `fixed.Interval` object, an array of `fixed.Interval` objects, or a cell array containing inputs to the `fixed.Interval` constructor.

If you do not specify an interval, the default interval uses end points equal to the minimum and maximum representable values of the specified numeric type.

Example: `dataspec.Intervals = {-1,1};`

Example: `dataspec.Intervals = fixed.Interval(-1,1);`

ExcludeDenormals — Whether to exclude denormal numbers from generated data

`false` (default) | `true`

Whether to exclude denormal numbers from generated data, specified as a logical.

This property is only applicable when the `DataTypeStr` property is a floating-point type.

Data Types: `logical`

ExcludeNegativeZero — Whether to exclude negative zero from generated data

`false` (default) | `true`

Whether to exclude negative zero from generated data, specified as a logical.

This property is only applicable when the `DataTypeStr` property is a floating-point type.

Data Types: `logical`

MandatoryValues — Values to include in the generated data

`<empty>` (default) | scalar | vector | matrix | multidimensional array

Values to include in the generated data, specified as a scalar, vector, matrix, or multidimensional array. If the values specified in `MandatoryValues` are outside the range of the data type specified in `DataTypeStr`, the values are saturated to the nearest representable value.

Example: `dataspec.MandatoryValues = [-215, 216];`

Data Types: `single` | `double` | `int8` | `int16` | `int32` | `int64` | `uint8` | `uint16` | `uint32` | `uint64` | `logical` | `fi`

Complexity — Complexity of generated data

`'real'` (default) | `'complex'`

Complexity of the generated data, specified as either `'real'` or `'complex'`.

Example: `dataspec.Complexity = 'complex';`

Data Types: `char` | `string`

Dimensions — Dimension of the generated data

1 (default) | positive scalar integer | row vector of positive integers

Dimension of the generated data, specified as a positive scalar integer or row vector of positive integers.

Example: `dataspec.Dimensions = 3;`

Data Types: `single | double | int8 | int16 | int32 | int64 | uint8 | uint16 | uint32 | uint64`

Object Functions

`contains` Determine whether value domain of a `DataSpecification` object contains a specified value

`applyOnRootInport` (To be removed) Apply properties to Inport block

Examples

Create a fixed.DataSpecification object

Create a `fixed.DataSpecification` object with default property values and an `int16` data type.

```
dataspec = fixed.DataSpecification('int16')

dataspec =
    fixed.DataSpecification with properties:
        DataTypeStr: 'int16'
        Intervals: [-32768,32767]
        MandatoryValues: <empty>
        Complexity: 'real'
        Dimensions: 1
```

The default interval of the `DataSpecification` object is equal to the range of the data type specified in the constructor.

Create a fixed.DataSpecification object from a fixed.Interval object

Create a `fixed.Interval` object specifying a range of $-\pi$ to π .

```
interval = fixed.Interval(-pi,pi)

interval =
    [-3.1416,3.1416]

    1x1 fixed.Interval with properties:
        LeftEnd: -3.1416
        RightEnd: 3.1416
        IsLeftClosed: true
        IsRightClosed: true
```

Create a `DataSpecification` object using this interval and a data type of `fixdt(1,16,10)`.

```
dataspec = fixed.DataSpecification('fixdt(1,16,10)', 'Intervals', interval)

dataspec =
    fixed.DataSpecification with properties:
```

```

    DataTypeStr: 'sfix16_En10'
      Intervals: [-3.1416,3.1416]
MandatoryValues: <empty>
  Complexity: 'real'
  Dimensions: 1

```

Alternatively, you can specify the interval as a cell array of inputs to the `fixed.Interval` constructor. The following code generates an equivalent `DataSpecification` object.

```
dataspec = fixed.DataSpecification('fixdt(1,16,10)', 'Intervals', {-pi,pi})
```

```
dataspec =
  fixed.DataSpecification with properties:
```

```

    DataTypeStr: 'sfix16_En10'
      Intervals: [-3.1416,3.1416]
MandatoryValues: <empty>
  Complexity: 'real'
  Dimensions: 1

```

Create a `DataSpecification` object that includes NaN and Inf

You can include NaN and Inf values in the generated data by specifying these values as intervals in an `Interval` object.

The following code creates a `DataSpecification` object that references an array of interval objects that include the values -Inf, Inf, NaN, and the range [-1, 1].

```
dataspec = fixed.DataSpecification('single', 'Intervals', ...
  {-Inf}, {Inf}, {NaN}, {-1,1})
```

```
dataspec =
  fixed.DataSpecification with properties:
```

```

    DataTypeStr: 'single'
      Intervals: [-Inf] [-1,1] [Inf] [NaN]
ExcludeDenormals: false
ExcludeNegativeZero: false
MandatoryValues: <empty>
  Complexity: 'real'
  Dimensions: 1

```

See Also

Objects

`fixed.DataGenerator` | `fixed.Interval`

Introduced in R2019b

fixed.Interval

Define interval of values

Description

A `fixed.Interval` object defines an interval of real-world values. Use the `Interval` object to specify a range of values in a `fixed.DataSpecification` object.

Creation

Syntax

```
interval = fixed.Interval  
interval = fixed.Interval(a)  
interval = fixed.Interval(a, b)  
interval = fixed.Interval(a, b, endnotes)  
interval = fixed.Interval(a, b, Name, Value)  
interval = fixed.Interval(numerictype)  
interval = fixed.Interval({ __ }, ..., { __ })
```

Description

`interval = fixed.Interval` creates a unit interval, [0,1].

`interval = fixed.Interval(a)` creates a degenerate interval, containing only the value `a`.

`interval = fixed.Interval(a, b)` creates a closed interval from `a` to `b`.

`interval = fixed.Interval(a, b, endnotes)` creates an interval from `a` to `b`, with the `endnotes` argument specifying whether the interval is open or closed.

`interval = fixed.Interval(a, b, Name, Value)` creates an interval from `a` to `b` with the `IsLeftClosed` and `IsRightClosed` properties specified as `Name, Value` pair arguments.

`interval = fixed.Interval(numerictype)` creates an interval or array of intervals with end points equal to the minimum and maximum representable values of the specified numeric type.

`interval = fixed.Interval({ __ }, ..., { __ })` returns an array of `Interval` objects, where each cell array specifies the arguments for one or more of the objects.

Input Arguments

a — Left endpoint of interval

scalar | vector

Left endpoint of interval, specified as a scalar or vector.

b — Right endpoint of interval

scalar | vector

Right endpoint of interval, specified as a scalar or vector.

endnotes — Whether the interval is open or closed

'[]' (default) | '[' | '(' | ')' | '()'

Argument indicating whether the interval is closed, open, or half-open, specified as one of the following character vectors.

Endnotes	Description
'[]'	Generates a closed set, which includes both of its endpoints.
'['	Generates a half-open interval, in which the first endpoint is included, but the second is not included in the set.
'('	Generates a half-open interval, in which the first endpoint is not included, but the second is included in the set.
'()'	Generates an open set, in which neither endpoint is included in the set.

Example: `interval = fixed.Interval(1, 10, '()');`

numerictype — Numeric data type

Simulink.NumericType object | embedded.numericType object | character vector

Numeric data type whose range of representable values defines the Interval object, specified as a Simulink.NumericType object, an embedded.numericType object, or a character vector representing a numeric data type, for example, 'single'.

When numericType is 'double', 'single', or 'half', the output Interval object is an array of 4 Interval objects with intervals [-Inf], [Inf], [NaN], and [-realmax, realmax]. For more information on representable values of a data type, see realmax.

Example: `interval = fixed.Interval('fixdt(1,16,8)');`

Properties

LeftEnd — Left endpoint of interval

0 (default) | scalar

Left endpoint of interval, specified as a scalar.

This property cannot be edited after object creation.

Data Types: half | single | double | int8 | int16 | int32 | int64 | uint8 | uint16 | uint32 | uint64 | logical | fi

RightEnd — Right endpoint of interval

1 (default) | scalar

Right endpoint of interval, specified as a scalar.

This property cannot be edited after object creation.

Data Types: `half | single | double | int8 | int16 | int32 | int64 | uint8 | uint16 | uint32 | uint64 | logical | fi`

IsLeftClosed — Whether the left end of the interval is closed

`true (default) | false`

Whether the left end of the interval is closed, specified as a logical value.

This property cannot be edited after object creation.

Data Types: `logical`

IsRightClosed — Whether the right end of the interval is closed

`true (default) | false`

Whether the right end of the interval is closed, specified as a logical value.

This property cannot be edited after object creation.

Data Types: `logical`

Object Functions

<code>contains</code>	Determine if one <code>fixed.Interval</code> object contains another
<code>intersect</code>	Intersection of <code>fixed.Interval</code> objects
<code>isDegenerate</code>	Determine whether the left and right ends of a <code>fixed.Interval</code> object are degenerate
<code>isLeftBounded</code>	Determine whether a <code>fixed.Interval</code> object is left-bounded
<code>isRightBounded</code>	Determine whether the a <code>fixed.Interval</code> object is right-bounded
<code>isnan</code>	Determine whether a <code>fixed.Interval</code> object is NaN
<code>overlaps</code>	Determine if two <code>fixed.Interval</code> objects overlap
<code>quantize</code>	Quantize interval to range of numeric data type
<code>setdiff</code>	Set difference of <code>fixed.Interval</code> objects
<code>union</code>	Union of <code>fixed.Interval</code> objects
<code>unique</code>	Get set of unique values in <code>fixed.Interval</code> object

Examples

Create a degenerate interval

Create a degenerate interval, containing only a single point.

```
interval = fixed.Interval(pi)
```

```
interval =  
    [3.1416]
```

1x1 `fixed.Interval` with properties:

```
    LeftEnd: 3.1416  
    RightEnd: 3.1416  
    IsLeftClosed: true  
    IsRightClosed: true
```

This is equivalent to creating an interval with two equivalent endpoints.

```
interval = fixed.Interval(pi, pi)
```

```
interval =
  [3.1416]

1x1 fixed.Interval with properties:
    LeftEnd: 3.1416
    RightEnd: 3.1416
    IsLeftClosed: true
    IsRightClosed: true
```

Create an open interval

Specify end notes for an interval to create an open interval.

```
interval = fixed.Interval(-1, 1, '()') %#ok<*NASGU>

interval =
  (-1,1)

1x1 fixed.Interval with properties:
    LeftEnd: -1
    RightEnd: 1
    IsLeftClosed: false
    IsRightClosed: false
```

To create an interval that includes the first endpoint, but not the second, specify the end notes as '[]'

```
interval = fixed.Interval(-1, 1, '[]')

interval =
  [-1,1)

1x1 fixed.Interval with properties:
    LeftEnd: -1
    RightEnd: 1
    IsLeftClosed: true
    IsRightClosed: false
```

Create an interval with the range of a numeric data type

When you specify a numeric data type in the constructor of the `fixed.Interval` object, the range of the interval is set to the range of the data type.

Create an interval with the range of an `int8` data type.

```
interval_int8 = fixed.Interval('int8')

interval_int8 =
  [-128,127]
```

```
1x1 fixed.Interval with properties:
```

```
    LeftEnd: -128
    RightEnd: 127
    IsLeftClosed: true
    IsRightClosed: true
```

You can also specify a `Simulink.NumericType` to create an interval with the same range as the range representable by the `NumericType` object.

```
myNumericType = Simulink.NumericType;
myNumericType.DataTypeMode = "Fixed-point: binary point scaling";
myNumericType.Signedness = 'Unsigned';
myNumericType.WordLength = 16;
myNumericType.FractionLength = 14
```

```
myNumericType =
  NumericType with properties:
```

```
    DataTypeMode: 'Fixed-point: binary point scaling'
    Signedness: 'Unsigned'
    WordLength: 16
    FractionLength: 14
    IsAlias: 0
    DataScope: 'Auto'
    HeaderFile: ''
    Description: ''
```

```
interval_16_14 = fixed.Interval(myNumericType)
```

```
interval_16_14 =
    [0,3.9999]
```

```
1x1 fixed.Interval with properties:
```

```
    LeftEnd: 0
    RightEnd: 3.9999
    IsLeftClosed: true
    IsRightClosed: true
```

Create an array of fixed.Interval objects

To create an array of `fixed.Interval` objects, in the constructor of the `Interval` object, you can specify a series of cell arrays, each of which contain the arguments of an `Interval` object.

```
intervalarray = fixed.Interval({-1,1},{5,10,['[]']},...
    {1000,1500,'IsLeftClosed',1,'IsRightClosed',0},...
    {'int8'})
```

```
intervalarray=1x4 object
    [-1,1]    [5,10]    [1000,1500]    [-128,127]
```

```
1x4 fixed.Interval with properties:
```

```
    LeftEnd
```

RightEnd
IsLeftClosed
IsRightClosed

See Also

Objects

fixed.DataGenerator | fixed.DataSpecification

Introduced in R2019b

LUTCompressionResult

Optimized lookup table data for all Lookup Table blocks in a system

Description

A `LUTCompressionResult` object contains the optimized lookup table data for all Lookup Table blocks in a system. To create a `LUTCompressionResult` object, use the `FunctionApproximation.compressLookupTables` function. To replace the lookup tables in your system with the optimized version, use the `replace` function.

Creation

Syntax

```
CompressionResult = compressLookupTables(system)
CompressionResult = compressLookupTables(system, Name, Value)
```

Description

`CompressionResult = compressLookupTables(system)` compresses all n-D Lookup Table blocks in the specified system. The compressed Lookup Table blocks output the same numerical results as the original Lookup Table blocks within the bounds of the breakpoints.

You can achieve additional memory savings by compressing each Lookup Table block in the model individually and specifying tolerances for the compressed lookup table.

`CompressionResult = compressLookupTables(system, Name, Value)` compresses all n-D Lookup Table blocks in the specified system with additional properties specified by name and value pair arguments.

Input Arguments

system — Name of model or subsystem in which to compress all Lookup Table blocks

character vector

Name of model or subsystem in which to compress all n-D Lookup Table blocks, specified as a character vector.

```
Example: compressionResult =
FunctionApproximation.compressLookupTables('sldemo_fuelsys');
```

Data Types: char

Name-Value Pair Arguments

Specify optional comma-separated pairs of `Name`, `Value` arguments. `Name` is the argument name and `Value` is the corresponding value. `Name` must appear inside quotes. You can specify several name and value pair arguments in any order as `Name1, Value1, ..., NameN, ValueN`.

Display — Whether to display details of each iteration of the optimization

true (default) | false

Whether to display details of each iteration of the optimization, specified as a logical. A value of 1 results in information in the command window at each iteration of the approximation process. A value of 0 does not display information until the approximation is complete.

Data Types: logical

WordLengths — Word lengths permitted in the lookup table approximate

integer scalar | integer vector

Specify the word lengths, in bits, that can be used in the lookup table approximate based on your intended hardware. For example, if you intend to target an embedded processor, you can restrict the data types in your lookup table to native types, 8, 16, and 32. The word lengths must be between 1 and 128.

Data Types: single | double | int8 | int16 | int32 | int64 | uint8 | uint16 | uint32 | uint64 | fi

FindOptions — Options for finding lookup tables in system

Simulink.FindOptions object

Simulink.FindOptions object specifying options for finding lookup tables in the system.

Properties**MemoryUnits — Units for memory usage**

'bytes' (default) | 'bits' | 'Kb' | 'Kibit' | 'KB' | 'KiB' | 'Mb' | 'Mibit' | 'MB' | 'MiB' | 'Gb' | 'Gibit' | 'GB' | 'GiB'

Units for MaxMemoryUsage property, specified as 'bits', 'bytes', or one of the other enumerated options.

Data Types: char

MemoryUsageTable — Table summarizing the effects of compression

table

Table summarizing the effects of compression. The table contains one row for each lookup table compressed in the system and its corresponding memory savings.

Data Types: table

NumLUTsFound — Number of lookup tables found in system

integer-valued scalar

Number of lookup tables found in the specified system, specified as an integer-valued scalar.

Data Types: double

NumImprovements — Number of lookup tables compressed

integer-valued scalar

Number of lookup tables compressed in the system, specified as an integer-valued scalar.

Data Types: double

TotalMemoryUsed — Total memory of all lookup tables in system before compression

scalar

Total memory of all lookup tables in the system before compression, returned as a scalar. You can specify the units of this property by using the `MemoryUnits` property.

Data Types: double

TotalMemoryUsedNew — Total memory of all lookup tables in system after compression

scalar

Total memory of all lookup tables in the system after compression, returned as a scalar. You can specify the units of this property by using the `MemoryUnits` property.

Data Types: double

TotalMemorySavings — Difference between total memory before compression and after compression

scalar

Difference between the total memory of all lookup tables in the system before and after compression, returned as a scalar. You can specify the units of this property by using the `MemoryUnits` property.

Data Types: double

TotalMemorySavingsPercent — Percentage reduction in memory used by lookup tables in the system

scalar

Percentage reduction in the memory used by the lookup tables in the system after compression, returned as a scalar.

Data Types: double

SUD — System containing compressed lookup tables

character vector

System containing compressed lookup tables, returned as a character vector. SUD is the same as the `system` input argument of the `FunctionApproximation.compressLookupTables` function.

Data Types: char

WordLengths — Word lengths used for breakpoints and table data in the compressed lookup tables

scalar | vector

Word lengths used for breakpoints and table data in the compressed lookup tables, returned as a scalar or vector of integers.

Data Types: double

FindOptions — Options for finding lookup tables in system`Simulink.FindOptions` object

`Simulink.FindOptions` object specifying options for finding lookup tables in the system.

Object Functions

replace Replace all Lookup Table blocks with compressed lookup tables
 revert Revert compressed Lookup Table blocks to original versions

Examples

Compress All Lookup Table Blocks in a System

This example shows how to compress all Lookup Table blocks in a system.

Open the model containing the lookup tables that you want to compress.

```
system = 'sldemo_fuelsys';
open_system(system)
```

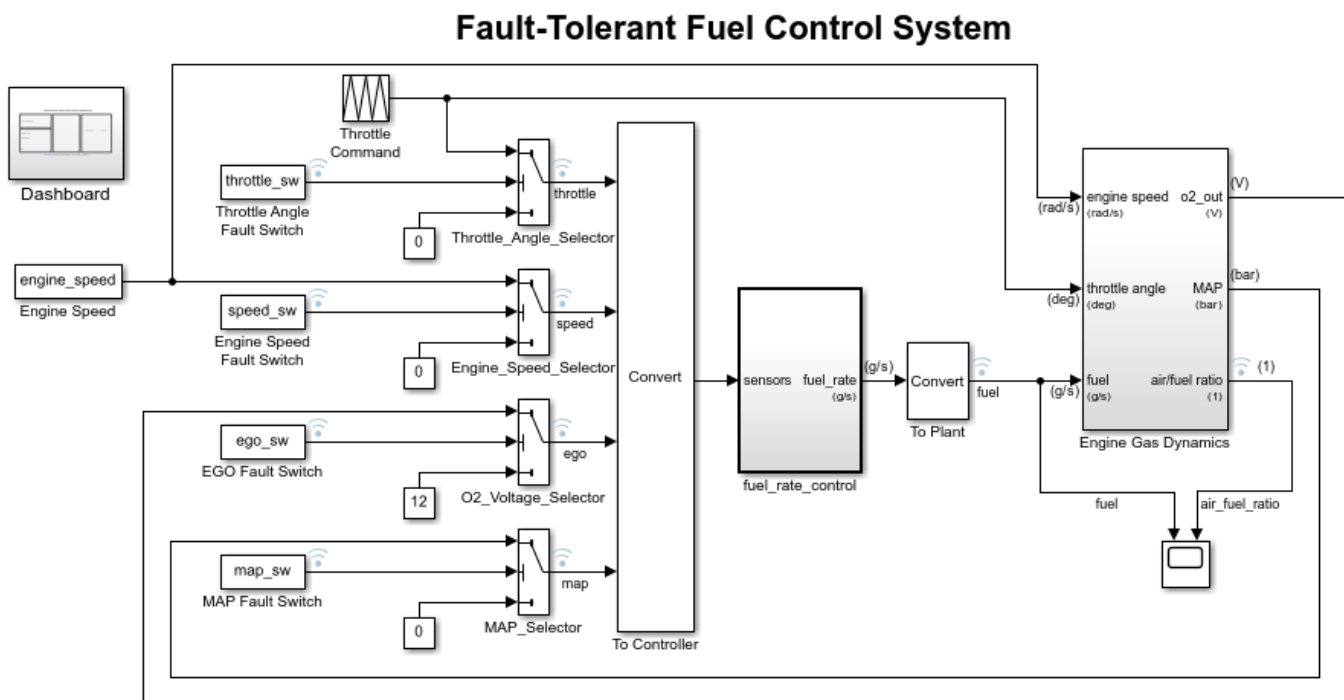

[Open the Dashboard](#) subsystem to simulate any combination of sensor failures.

Copyright 1990-2017 The MathWorks, Inc.

Use the `FunctionApproximation.compressLookupTables` function to compress all of the lookup tables in the model. The output specifies all blocks that are modified and the memory savings for each.

```
compressionResult = FunctionApproximation.compressLookupTables(system)
```

- Found 5 supported lookup tables
- Percent reduction in memory for compressed solution
 - 2.37% for sldemo_fuelsys/fuel_rate_control/airflow_calc/Pumping Constant
 - 2.37% for sldemo_fuelsys/fuel_rate_control/control_logic/Throttle.throttle_estimate/Throt
 - 3.55% for sldemo_fuelsys/fuel_rate_control/control_logic/Speed.speed_estimate/Speed Estim
 - 6.38% for sldemo_fuelsys/fuel_rate_control/control_logic/Pressure.map_estimate/Pressure E

```
- 9.38% for sldemo_fuelsys/fuel_rate_control/airflow_calc/Ramp Rate Ki  
compressionResult =  
LUTCompressionResult with properties:  
    MemoryUnits: bytes  
    MemoryUsageTable: [5x5 table]  
    NumLUTsFound: 5  
    NumImprovements: 5  
    TotalMemoryUsed: 6024  
    TotalMemoryUsedNew: 5796  
    TotalMemorySavings: 228  
    TotalMemorySavingsPercent: 3.7849  
    SUD: 'sldemo_fuelsys'  
    WordLengths: [8 16 32]  
    FindOptions: [1x1 Simulink.internal.FindOptions]  
    Display: 1
```

Use the `replace` function to replace each Lookup Table block with a block containing the original and compressed version of the lookup table.

```
replace(compressionResult);
```

You can revert the lookup tables back to their original state using the `revert` function.

```
revert(compressionResult);
```

See Also

Functions

`FunctionApproximation.compressLookupTables` | `replace` | `revert`

Introduced in R2020a

FunctionApproximation.LUTMemoryUsageCalculator class

Package: FunctionApproximation

Calculate memory used by lookup table blocks in a system

Description

The `FunctionApproximation.LUTMemoryUsageCalculator` class helps to calculate the memory used by each lookup table block, including 1-D Lookup Table, 2-D Lookup Table, and n-D Lookup Table, used in a model.

Construction

`calculator = FunctionApproximation.LUTMemoryUsageCalculator()` creates a `FunctionApproximation.LUTMemoryUsageCalculator` object. Use the `lutmemoryusage` method to calculate the memory used by each lookup table block in a model.

Properties

Public Properties

FindOptions — Options for finding lookup table blocks in a system

`Simulink.FindOptions` object

Options for finding lookup table blocks in a system, specified as a `Simulink.FindOptions` object.

Methods

`lutmemoryusage` Calculate memory used by lookup table blocks in a system

Copy Semantics

Handle. To learn how handle classes affect copy operations, see [Copying Objects](#).

Examples

Calculate the Total Memory Used by Lookup Tables in a Model

Use the `FunctionApproximation.LUTMemoryUsageCalculator` class to calculate the total memory used by lookup table blocks in a model.

Create a `FunctionApproximation.LUTMemoryUsageCalculator` object.

```
calculator = FunctionApproximation.LUTMemoryUsageCalculator
```

Use the `lutmemoryusage` method to get the memory used by each lookup table block in the `sldemo_fuelsys` model.

```
load_system('sldemo_fuelsys')
lutmemoryusage(calculator, 'sldemo_fuelsys')
```

```
ans =
```

```
5×2 table
```

```
BlockPath
```

```
1 "sldemo_fuelsys/fuel_rate_control/airflow_calc/Pumping Constant"
2 "sldemo_fuelsys/fuel_rate_control/control_logic/Throttle.throttle_estimate/Throttle Est.
3 "sldemo_fuelsys/fuel_rate_control/control_logic/Speed.speed_estimate/Speed Estimation"
4 "sldemo_fuelsys/fuel_rate_control/control_logic/Pressure.map_estimate/Pressure Estimation"
5 "sldemo_fuelsys/fuel_rate_control/airflow_calc/Ramp Rate Ki"
```

See Also

Apps

Lookup Table Optimizer

Classes

FunctionApproximation.LUTSolution | FunctionApproximation.Options |
FunctionApproximation.Problem

Functions

approximate | compare | displayallsolutions | displayfeasiblesolutions |
lutmemoryusage | solutionfromID | solve | totalmemoryusage

Topics

“Optimize Lookup Tables for Memory-Efficiency Programmatically”
“Optimize Lookup Tables for Memory-Efficiency”

Introduced in R2018a

FunctionApproximation.LUTSolution class

Package: FunctionApproximation

Optimized lookup table data or lookup table data approximating a math function

Description

A `FunctionApproximation.LUTSolution` object contains optimized lookup table data or lookup table data approximating a math function. To create a `FunctionApproximation.LUTSolution` object, use the `solve` method on a `FunctionApproximation.Problem` object. To generate a subsystem containing the lookup table approximate or the optimized lookup table, use the `approximate` method of the `FunctionApproximation.LUTSolution` object.

You can save a `FunctionApproximation.LUTSolution` object to a MAT-file and restore the solution later.

Construction

`solution = solve(problem)` solves the problem defined by the `FunctionApproximation.Problem` object, `problem`, and returns the approximation or optimization, `solution`, as a `FunctionApproximation.LUTSolution` object.

Input Arguments

problem — Function to approximate, or lookup table to optimize

`FunctionApproximation.Problem` object

Function to approximate, or lookup table to optimize, and the constraints to consider during the optimization, specified as a `FunctionApproximation.Problem` object.

Properties

ID — ID of the solution

scalar integer

ID of the solution, specified as a scalar integer.

This property is read-only.

Data Types: `double`

Feasible — Whether the approximation meets the constraints

`true` | `false`

Whether the approximation or optimization specified by the `FunctionApproximation.LUTSolution` object, `solution`, meets the constraints specified in the `FunctionApproximation.Problem` object, `problem`, and its associated `FunctionApproximation.Options`.

This property is read-only.

Data Types: `logical`

ALLSolutions — All solutions, including infeasible solutions

vector of `FunctionApproximation.LUTSolution` objects

All solutions found during the approximation, including infeasible solutions, specified as a vector of `FunctionApproximation.LUTSolution` objects.

This property is read-only.

FeasibleSolutions — All solutions that meet the constraints

vector of `FunctionApproximation.LUTSolution` objects

All solutions meeting the specified constraints, specified as a vector of `FunctionApproximation.LUTSolution` objects.

This property is read-only.

PercentReduction — Reduction in memory of lookup table

scalar

If the original `FunctionApproximation.Problem` object specified a lookup table block to optimize, the `PercentReduction` property indicates the reduction in memory from the original lookup table. If the original `FunctionApproximation.Problem` object specified a math function or function handle, the `PercentReduction` is `-Inf`.

This property is read-only.

Data Types: `double`

SourceProblem — Problem object approximated by the solution

`FunctionApproximation.Problem` object

`FunctionApproximation.Problem` object that the `FunctionApproximation.LUTSolution` object approximates.

This property is read-only.

TableData — Lookup table data

struct

Struct containing data related to lookup table approximation. The struct has the following fields.

- `BreakpointValues` - Breakpoints of the lookup table
- `BreakpointDataTypes` - Data type of the lookup table breakpoints
- `TableValues` - Values in the lookup table
- `TableDataType` - Data type of the table data
- `IsEvenSpacing` - Boolean value indicating if the breakpoints are evenly spaced.

This property is read-only.

Methods

approximate	Generate a Lookup Table block from a <code>FunctionApproximation.LUTSolution</code>
compare	Compare numerical results of <code>FunctionApproximation.LUTSolution</code> to original function or lookup table
displayallsolutions	Display all solutions found during function approximation
displayfeasiblesolutions	Display all feasible solutions found during function approximation
getErrorValue	Get the total error of the lookup table approximation
replaceWithApproximate	Replace block with the generated lookup table approximation
revertToOriginal	Revert the block that was replaced by the approximation back to its original state
solutionfromID	Access a solution found during the approximation process
totalmemoryusage	Calculate total memory used by a lookup table approximation

Copy Semantics

Handle. To learn how handle classes affect copy operations, see [Copying Objects](#).

See Also

Apps

Lookup Table Optimizer

Classes

`FunctionApproximation.Problem` | `FunctionApproximation.LUTMemoryUsageCalculator` | `FunctionApproximation.Options`

Functions

`approximate` | `compare` | `solve`

Topics

“Optimize Lookup Tables for Memory-Efficiency Programmatically”
 “Optimize Lookup Tables for Memory-Efficiency”

Introduced in R2018a

FunctionApproximation.Options class

Package: FunctionApproximation

Specify additional options to use with `FunctionApproximation.Problem` object

Description

The `FunctionApproximation.Options` object contains additional options for defining a `FunctionApproximation.Problem` object.

Construction

`options = FunctionApproximation.Options()` creates a `FunctionApproximation.Options` object to use as an input to a `FunctionApproximation.Problem` object. The output, `options`, uses default property values.

`options = FunctionApproximation.Options(Name, Value)` creates a `FunctionApproximation.Options` object with property values specified by one or more `Name, Value` pair arguments. `Name` must appear inside single quotes (' '). You can specify several name-value pair arguments in any order as `Name1, Value1, . . . , NameN, ValueN`.

Properties

AbsTol — Absolute tolerance of difference between original and approximate

non-negative scalar

Maximum tolerance of the absolute value of the difference between the original output value and the output value of the approximation, specified as a non-negative scalar.

Data Types: `single` | `double` | `int8` | `int16` | `int32` | `int64` | `uint8` | `uint16` | `uint32` | `uint64` | `fi`

AllowUpdateDiagram — Whether to allow updating of the model diagram during the approximation process

`true` or `1` (default) | `false` or `0`

Whether to allow updating of the model diagram during the approximation process, specified as a numeric or logical `1` (`true`) or `0` (`false`). This property is only relevant for `FunctionApproximation.Problem` objects that specify a Lookup Table block, or a Math Function block as the item to approximate.

Data Types: `logical`

AUTOSARCompliant — Whether the generated lookup table block is an AUTOSAR block

`false` or `0` (default) | `true` or `1`

Whether the generated lookup table is AUTOSAR compliant, specified as a numeric or logical `1` (`true`) or `0` (`false`). When this property is set to `1` (`true`), the generated lookup table is a Curve or Map block from the AUTOSAR Blockset. When this property is set to `1` (`true`), the data type of the table data must equal the output data type of the block.

Setting this property to 1 (`true`) checks out a AUTOSAR Blockset license when you use the `approximate` or `replaceWithApproximate` methods.

Data Types: `logical`

BreakpointSpecification — Spacing of breakpoint data

`ExplicitValues` (default) | `EvenSpacing` | `EvenPow2Spacing`

Spacing of breakpoint data, specified as one of the following values.

Breakpoint Specification	Description
<code>ExplicitValues</code>	Lookup table breakpoints are specified explicitly. Breakpoints can be closer together for some input ranges and farther apart in others.
<code>EvenSpacing</code>	Lookup table breakpoints are evenly spaced throughout.
<code>EvenPow2Spacing</code>	Lookup table breakpoints use power-of-two spacing. This breakpoint specification boasts the fastest execution speed because a bit shift can replace the position search.

For more information on how breakpoint specification can affect performance, see “Effects of Spacing on Speed, Error, and Memory Usage”.

Data Types: `char`

Display — Whether to display details of each iteration of the optimization

`true` or 1 (default) | `false` or 0

Whether to display details of each iteration of the optimization, specified as a numeric or logical 1 (`true`) or 0 (`false`). A value of 1 (`true`) results in information in the command window at each iteration of the approximation process. A value of 0 (`false`) does not display information until the approximation is complete.

Data Types: `logical`

ExploreHalf — Whether to allow exploration of half precision

`true` or 1 (default) | `false` or 0

Whether to allow the optimizer to explore half-precision data types for table data and breakpoints, specified as a numeric or logical 1 (`true`) or 0 (`false`).

Data Types: `logical`

HDLOptimized — Whether to generate HDL-optimized approximate

`false` or 0 (default) | `true` or 1

Whether to generate an HDL-optimized approximate, specified as a numeric or logical 1 (`true`) or 0 (`false`). A value of 1 (`true`) results in the approximate being a subsystem consisting of a prelookup step followed by interpolation that functions as a lookup table with explicit pipelining to generate efficient HDL code.

To generate an HDL-optimized approximate, the function to approximate must be one-dimensional and `BreakpointSpecification` must be set to `EvenSpacing` or `EvenPow2Spacing`.

Data Types: `logical`

Interpolation — Method when an input falls between breakpoint values

`Linear` (default) | `Flat` | `Nearest` | `None`

When an input falls between breakpoint values, the lookup table interpolates the output value using neighboring breakpoints.

Interpolation Method	Description
Linear	Fits a line between the adjacent breakpoints, and returns the point on that line corresponding to the input.
Flat	Returns the output value corresponding to the breakpoint value that is immediately less than the input value. If no breakpoint value exists below the input value, it returns the breakpoint value nearest the input value.
Nearest	Returns the value corresponding to the breakpoint that is closest to the input. If the input is equidistant from two adjacent breakpoints, the breakpoint with the higher index is chosen.
None	Generates a Direct Lookup Table (n-D) block, which performs table lookups without any interpolation or extrapolation.
	Note When generating a Direct Lookup Table block, the maximum number of inputs is two.

Data Types: `char`

MaxMemoryUsage — Maximum amount of memory the generated lookup table can use

80000000 (default) | scalar integer

The maximum amount of memory the generated lookup table can use, in bits, specified as a scalar integer. You can change the units of the option using the `MemoryUnits` property.

Data Types: `double`

MaxTime — Maximum amount of time for the approximation to run (in seconds)

`Inf` (default) | scalar

Maximum amount of time for the approximation to run, specified in seconds as a scalar number. The approximation runs until it reaches the time specified, finds an ideal solution, or reaches another stopping criteria.

Data Types: `double`

MemoryUnits — Units for maximum memory usage

'bits' (default) | 'bytes' | 'Kb' | 'Kibit' | 'KB' | 'KiB' | 'Mb' | 'Mibit' | 'MB' | 'MiB' | 'Gb' | 'Gibit' | 'GB' | 'GiB'

Units for `MaxMemoryUsage` property, specified as 'bits', 'bytes', or one of the other enumerated options.

Data Types: `char`

OnCurveTableValues — Whether to constrain table values to the quantized output of the function being approximated

`false` or `0` (default) | `true` or `1`

Whether to constrain table values to the quantized output of the function being approximated, specified as a numeric or logical `1` (`true`) or `0` (`false`). By setting this property to `0` (`false`) and allowing off-curve table values, you may be able to reduce the memory of the lookup table while maintaining the same error tolerances, or maintain the same memory while reducing the error tolerances.

Data Types: `logical`

RelTol — Relative tolerance of difference between original and approximate

non-negative scalar

Maximum tolerance of the relative difference between the original output value and the output value of the approximation, specified as a non-negative scalar.

Data Types: `single` | `double` | `int8` | `int16` | `int32` | `int64` | `uint8` | `uint16` | `uint32` | `uint64` | `fi`

SaturateToOutputType — Saturate output of function to approximate to range of output type

`false` or `0` (default) | `true` or `1`

Whether to automatically saturate the range of the output of the function to approximate to the range of the output data type, specified as a numeric or logical `1` (`true`) or `0` (`false`).

Example: `options.SaturateToOutputType = 1;`

Data Types: `logical`

UseParallel — Whether to run iterations in parallel

`false` or `0` (default) | `true` or `1`

Whether to run iterations of the optimization in parallel, specified as a numeric or logical `1` (`true`) or `0` (`false`). Running the iterations in parallel requires a Parallel Computing Toolbox™ license. If you do not have a Parallel Computing Toolbox license, or if you specify `0` (`false`), the iterations run in serial.

Example: `options.UseParallel = true;`

Data Types: `logical`

WordLengths — Word lengths permitted in the lookup table approximate

`[8, 16, 32]` (default) | integer scalar | integer vector

Specify the word lengths, in bits, that can be used in the lookup table approximate based on your intended hardware. For example, if you intend to target an embedded processor, you can restrict the data types in your lookup table to native types, 8, 16, and 32. The word lengths must be between 1 and 128.

Example: `options.WordLengths = [8,16,32];`

Data Types: `single` | `double` | `int8` | `int16` | `int32` | `int64` | `uint8` | `uint16` | `uint32` | `uint64` | `fi`

Copy Semantics

Value. To learn how value classes affect copy operations, see Copying Objects.

Limitations

- Lookup table objects and breakpoint objects are not supported in a model mask workspace.

Algorithms

When you set `BreakpointSpecification` to `'ExplicitValues'`, during the approximation process, the algorithm also attempts to find a solution using `'EvenSpacing'` and `'EvenPow2Spacing'`. Likewise, when you set `BreakpointSpecification` to `'EvenSpacing'`, the algorithm also attempts to find a solution using `'EvenPow2Spacing'`. If you set the property to `'EvenPow2Spacing'`, the algorithm only attempts to find a solution using this spacing.

In cases where the `BreakpointSpecification` property is set to `'EvenSpacing'`, but the `InputUpperBounds` or `InputLowerBounds` property of the `FunctionApproximation.Problem` object is equal to the range of the `InputTypes`, the algorithm does not attempt to find a solution using `'EvenPow2Spacing'`.

See Also

Apps

Lookup Table Optimizer

Classes

`FunctionApproximation.LUTMemoryUsageCalculator` |
`FunctionApproximation.LUTSolution` | `FunctionApproximation.Options` |
`FunctionApproximation.Problem`

Functions

`approximate` | `compare` | `displayallsolutions` | `displayfeasiblesolutions` |
`lutmemoryusage` | `solutionfromID` | `solve` | `totalmemoryusage`

Topics

“Optimize Lookup Tables for Memory-Efficiency Programmatically”

“Optimize Lookup Tables for Memory-Efficiency”

Introduced in R2018a

FunctionApproximation.Problem class

Package: FunctionApproximation

Object defining the function to approximate, or the lookup table to optimize

Description

The `FunctionApproximation.Problem` object defines the function to approximate with a lookup table, or the lookup table block to optimize. After defining the problem, use the `solve` method to generate a `FunctionApproximation.LUTSolution` object that contains the approximation.

Construction

`approximationProblem = FunctionApproximation.Problem()` creates a `FunctionApproximation.Problem` object with default property values. When no function input is provided, the `FunctionToApproximate` property is set to `'sin'`.

`approximationProblem = FunctionApproximation.Problem(function)` creates a `FunctionApproximation.Problem` object to approximate the function, Math Function block, or lookup table specified by function.

Input Arguments

function — Function or block to approximate, or lookup table block to optimize

'sin' (default) | math function | function handle | Math Function block | Lookup Table block | Subsystem block

Function or block to approximate, or the lookup table block to optimize, specified as a function handle, a math function, a Simulink block or subsystem, or one of the lookup table blocks (for example, 1-D Lookup Table, n-D Lookup Table).

If you specify one of the lookup table blocks, the `solve` method generates an optimized lookup table.

If you specify a math function, a function handle, or a block, the `solve` method generates a lookup table approximation of the input function.

Function handles must be on the MATLAB search path, or approximation fails.

The MATLAB math functions supported for approximation are:

- `1./x`
- `10.^x`
- `2.^x`
- `acos`
- `acosh`
- `asin`
- `asinh`
- `atan`

- atan2
- atanh
- cos
- cosh
- exp
- log
- log10
- log2
- sin
- sinh
- sqrt
- tan
- tanh
- x.^2

Tip The process of generating a lookup table approximation is faster for a function handle than for a subsystem. If a subsystem can be represented by a function handle, it is faster to approximate the function handle.

Data Types: char | function_handle

Properties

FunctionToApproximate — Function to approximate, or lookup table block to optimize

'sin' (default) | math function | function handle | Math Function block | Lookup Table block | Subsystem block

Function or block to approximate, or the lookup table block to optimize, specified as a function handle, a math function, a Simulink block or subsystem, or one of the lookup table blocks (for example, 1-D Lookup Table, n-D Lookup Table).

If you specify one of the lookup table blocks, the `solve` method generates an optimized lookup table.

If you specify a math function, a function handle, or a block, the `solve` method generates a lookup table approximation of the input function.

Function handles must be on the MATLAB search path, or approximation fails.

The MATLAB math functions supported for approximation are:

- 1./x
- 10.^x
- 2.^x
- acos
- acosh

- `asin`
- `asinh`
- `atan`
- `atan2`
- `atanh`
- `cos`
- `cosh`
- `exp`
- `log`
- `log10`
- `log2`
- `sin`
- `sinh`
- `sqrt`
- `tan`
- `tanh`
- `x.^2`

Tip The process of generating a lookup table approximation is faster for a function handle than for a subsystem. If a subsystem can be represented by a function handle, it is faster to approximate the function handle.

Data Types: `char` | `function_handle`

NumberOfInputs — Number of inputs to function approximation

1 | 2 | 3

Number of inputs to approximated function. This property is inferred from the `FunctionToApproximate` property, therefore it is not a writable property.

If you are generating a Direct Lookup Table, the function to approximate can have no more than two inputs.

Data Types: `double`

InputTypes — Desired data types of inputs to function approximation

`numerictype` object | vector of `numerictype` objects | `Simulink.NumericType` object | vector of `Simulink.NumericType` objects

Desired data types of the inputs to the approximated function, specified as a `numerictype`, `Simulink.NumericType`, or a vector of `numerictype` or `Simulink.NumericType` objects. The number of `InputTypes` specified must match the `NumberOfInputs`.

Example: `problem.InputTypes = ["numerictype(1,16,13)", "numerictype(1,16,10)"];`

InputLowerBounds — Lower limit of range of inputs to function to approximate

`scalar` | `vector`

Lower limit of range of inputs to function to approximate, specified as a scalar or vector. If you specify `inf`, the `InputLowerBounds` used during the approximation is derived from the `InputTypes` property. The dimensions of `InputLowerBounds` must match the `NumberOfInputs`.

Data Types: `single` | `double` | `int8` | `int16` | `int32` | `int64` | `uint8` | `uint16` | `uint32` | `uint64` | `fi`

InputUpperBounds — Upper limit of range of inputs to function to approximate

`scalar` | `vector`

Upper limit of range of inputs to function to approximate, specified as a scalar or vector. If you specify `inf`, the `InputUpperBounds` used during the approximation is derived from the `InputTypes` property. The dimensions of `InputUpperBounds` must match the `NumberOfInputs`.

Data Types: `single` | `double` | `int8` | `int16` | `int32` | `int64` | `uint8` | `uint16` | `uint32` | `uint64` | `fi`

OutputType — Desired data type of the function approximation output

`numerictype` | `Simulink.Numerictype`

Desired data type of the function approximation output, specified as a `numerictype` or `Simulink.Numerictype`. For example, to specify that you want the output to be a signed fixed-point data type with 16-bit word length and best-precision fraction length, set the `OutputType` property to `"numerictype(1,16)"`.

Example: `problem.OutputType = "numerictype(1,16)";`

Options — Additional options and constraints to use in approximation

`FunctionApproximation.Options` object

Additional options and constraints to use in approximation, specified as a `FunctionApproximation.Options` object.

Methods

`solve` Solve for optimized solution to function approximation problem

Copy Semantics

Handle. To learn how handle classes affect copy operations, see [Copying Objects](#).

Examples

Create Problem Object to Approximate a Function Handle

Create a `FunctionApproximation.Problem` object, specifying a function handle that you want to approximate.

```
problem = FunctionApproximation.Problem(@(x,y) sin(x)+cos(y))
```

```
problem =
```

```
FunctionApproximation.Problem with properties
```



```

FunctionToApproximate: @(x,y)sin(x)+cos(y)
  NumberOfInputs: 2
    InputTypes: ["numerictype('double')" "numerictype('double')"]
  InputLowerBounds: [-Inf -Inf]
  InputUpperBounds: [Inf Inf]
  OutputType: "numerictype('double')"
  Options: [1x1 FunctionApproximation.Options]

```

The `FunctionApproximation.Problem` object, `problem`, uses default property values.

Set the range of the function inputs to be between zero and 2π .

```

problem.InputLowerBounds = [0,0];
problem.InputUpperBounds = [2*pi, 2*pi]

```

```

problem =

```

```

FunctionApproximation.Problem with properties

```

```

FunctionToApproximate: @(x,y)sin(x)+cos(y)
  NumberOfInputs: 2
    InputTypes: ["numerictype('double')" "numerictype('double')"]
  InputLowerBounds: [0 0]
  InputUpperBounds: [6.2832 6.2832]
  OutputType: "numerictype('double')"
  Options: [1x1 FunctionApproximation.Options]

```

Create Problem Object to Approximate a Math Function

Create a `FunctionApproximation.Problem` object, specifying a math function to approximate.

```

problem = FunctionApproximation.Problem('log')

```

```

problem =

```

```

FunctionApproximation.Problem with properties

```

```

FunctionToApproximate: @(x)log(x)
  NumberOfInputs: 1
    InputTypes: "numerictype(1,16,10)"
  InputLowerBounds: 0.6250
  InputUpperBounds: 15.6250
  OutputType: "numerictype(1,16,13)"
  Options: [1x1 FunctionApproximation.Options]

```

The math functions have appropriate input range, input data type, and output data type property defaults.

Create Problem Object to Optimize a Lookup Table Block

Create a `FunctionApproximation.Problem` object to optimize an existing lookup table.

```

load_system('sldemo_fuelsys');
problem = FunctionApproximation.Problem('sldemo_fuelsys/fuel_rate_control/airflow_calc/Pumping C

```

```

problem =

```

```

FunctionApproximation.Problem with properties

```

```

FunctionToApproximate: 'sldemo_fuelsys/fuel_rate_control/airflow_calc/Pumping Constant'
  NumberOfInputs: 2
    InputTypes: ["numerictype('single')" "numerictype('single')"]
  InputLowerBounds: [50 0.0500]
  InputUpperBounds: [1000 0.9500]
  OutputType: "numerictype('single')"
  Options: [1x1 FunctionApproximation.Options]

```

The software infers the properties of the problem object from the model.

Limitations

- Lookup table objects and breakpoint objects are not supported in a model mask workspace.

Algorithms

Required Specifications

Functions and function handles that you approximate must meet the following criteria.

- The function must be time-invariant.
- The function must operate element-wise, meaning for each input there is one output.
- The function must not contain states.

For more information, see “Vectorization”.

Infinite Upper and Lower Input Bounds

When a `Problem` object specifies infinite input ranges and the input type is non-floating-point, during the approximation, the software infers upper and lower ranges based on the range of the input data type. The resulting `FunctionApproximation.LUTSolution` object specifies the bounds that the algorithm used during the approximation, not the originally specified infinite bounds.

Upper and Lower Input Bounds and Input Data Type Range

If the `InputLowerBounds` or `InputUpperBounds` specified for a `Problem` object fall outside the range of the specified `InputTypes`, the algorithm uses the range of the data type specified by `InputTypes` for the approximation.

In cases where the `BreakpointSpecification` property of the `FunctionApproximation.Options` object is set to `'EvenSpacing'`, but the `InputUpperBounds` or `InputLowerBounds` property of the `FunctionApproximation.Problem` object is equal to the range of the `InputTypes`, the algorithm does not attempt to find a solution using `'EvenPow2Spacing'`.

See Also

Apps

Lookup Table Optimizer

Classes

`FunctionApproximation.LUTMemoryUsageCalculator` |
`FunctionApproximation.LUTSolution` | `FunctionApproximation.Options`

Functions

approximate | compare | solve

Topics

“Optimize Lookup Tables for Memory-Efficiency Programmatically”

“Optimize Lookup Tables for Memory-Efficiency”

Introduced in R2018a

fxpOptimizationOptions class

Specify options for data type optimization

Description

The `fxpOptimizationOptions` object enables you to specify options and constraints to use during the data type optimization process.

Construction

`opt = fxpOptimizationOptions()` creates a `fxpOptimizationOptions` object with default values.

`opt = fxpOptimizationOptions(Name, Value)` creates an `fxpOptimizationOptions` object with property values specified by one or more `Name, Value` pair arguments. `Name` must appear inside single quotes (`' '`). You can specify several name-value pair arguments in any order as `Name1, Value1, ..., NameN, ValueN`.

Properties

MaxIterations — Maximum number of iterations to perform

50 (default) | scalar integer

Maximum number of iterations to perform, specified as a scalar integer. The optimization process iterates through different solutions until it finds an ideal solution, reaches the maximum number of iterations, or reaches another stopping criteria.

Example: `opt.MaxIterations = 75;`

Data Types: double

MaxTime — Maximum amount of time for the optimization to run (in seconds)

600 (default) | scalar

Maximum amount of time for the optimization to run, specified in seconds as a scalar number. The optimization runs until it reaches the time specified, an ideal solution, or another stopping criteria.

Example: `opt.MaxTime = 1000;`

Data Types: double

Patience — Maximum number of iterations where no new best solution is found

10 (default) | scalar integer

Maximum number of iterations where no new best solution is found, specified as a scalar integer. The optimization continues as long as the algorithm continues to find new best solutions.

Example: `opt.Patience = 15;`

Data Types: double

Verbosity — Level of information displayed at the command line during the optimization

'High' (default) | 'Moderate' | 'Silent'

The level of information displayed at the command line during the optimization process, specified as either 'High', 'Moderate', or 'Silent'.

- 'Silent' - Nothing is displayed at the command line until the optimization process is finished
- 'Moderate' - Information is displayed at each major step of the optimization process, including when the process is in the preprocessing, modeling, and optimization phases.
- 'High' - Information is displayed at the command line at each iteration of the optimization process, including whether a new best solution was found, and the cost of the solution.

Example: `opt.Verbosity = 'Moderate';`

Data Types: `char` | `string`

AllowableWordLengths — Word lengths that can be used in your optimized system under design

[2:128] (default) | scalar integer | vector of integers

Specify the word lengths that can be used in your optimized system under design. Use this property to target the neighborhood search of the optimization process. The final result of the optimization uses word lengths in the intersection of the `AllowableWordLengths` and word lengths compatible with hardware constraints specified in the **Hardware Implementation** pane of your model.

Example: `opt.AllowableWordLengths = [8:11,16,32];`

Data Types: `double`

ObjectiveFunction — Objective function to use during optimization search

'BitWidthSum' (default) | 'OperatorCount'

Objective function to use during optimization search, specified as one of these values:

- 'BitWidthSum' — Minimize total bit width sum.
- 'OperatorCount' — Minimize estimated count of operators in generated C code.

This option may result in a lower program memory size for C code generated from Simulink models. The 'OperatorCount' objective function is not suitable for FPGA or ASIC targets.

Note To use 'OperatorCount' as the objective function during optimization, the model must be ready for code generation. For more information about determining code generation readiness, see “Check Model and Configuration for Code Generation” (Embedded Coder).

Data Types: `char`

UseParallel — Whether to run iterations in parallel

false (default) | true

Whether to run iterations of the optimization in parallel, specified as a logical. Running the iterations in parallel requires a Parallel Computing Toolbox license. If you do not have a Parallel Computing Toolbox license, or if you specify `false`, the iterations run in serial.

Data Types: `logical`

AdvancedOptions – Additional options for optimization

object

Additional advanced options for optimization. `AdvancedOptions` is an object containing additional properties that can affect the optimization.

Property	Description
<code>PerformNeighborhoodSearch</code>	<ul style="list-style-type: none"> • 1 (default) - Perform a neighborhood search for the optimized solution. • 0 - Do not perform a neighborhood search. Selecting this option can increase the speed of the optimization process, but also increases the chances of finding a less ideal solution.
<code>EnforceLooseCoupling</code>	<p>Some blocks have a parameter that forces inputs to share a data type, or forces the output to share the same data type as the input.</p> <ul style="list-style-type: none"> • 1 (default) - Allow the optimizer to relax this restriction on all blocks in the system under design. Relaxing this restriction enables the optimizer to provide better fitting data types. • 0 - Do not allow the optimizer to relax this restriction on blocks in the system under design.
<code>UseDerivedRangeAnalysis</code>	<ul style="list-style-type: none"> • 0 (default) - The optimizer does not consider ranges derived from design ranges in the model when assessing a solution. • 1 - The optimizer considers both observed simulation ranges and ranges derived from design ranges in the model when assessing a solution. <p>Depending on the model configuration, derived range analysis may take longer than simulation of the model.</p>
<code>SimulationScenarios</code>	<p>Define additional simulation scenarios to consider during optimization using a <code>Simulink.SimulationInput</code> object. For an example, see “Optimize Data Types Using Multiple Simulation Scenarios”.</p>
<code>SafetyMargin</code>	<p>Enter a safety margin, specified as a positive scalar value indicating the percentage increase in the bounds of the collected range. The safety margin is applied to the union of all collected ranges, including simulation ranges, derived ranges, and design ranges.</p>

Property	Description
DataTypeOverride	<p>Override data types specified in the model when simulating during the range collection phase of optimization.</p> <ul style="list-style-type: none"> 'Off' (default) - Do not override data types 'Single' - Override data types with singles 'Double' - Override data types with doubles 'ScaledDouble' - Override data types with scaled doubles
HandleUnsupported	<p>Some blocks are not supported for fixed-point conversion. For more information, see “Blocks That Do Not Support Fixed-Point Data Types”.</p> <ul style="list-style-type: none"> 'Isolate' (default) - Isolate unsupported blocks with Data Type Conversion blocks. Isolated blocks are ignored by the optimizer. 'Error' - Stop optimization and report an error when the system contains blocks that are not supported for fixed-point conversion.
PerformSlopeBiasCancellation	<ul style="list-style-type: none"> 0 (default) - Do not propagate slope-bias data types. 1 - Propagate slope-bias data types from outside the system under design. Slopes and biases are chosen to reduce the complexity of generated code.

Methods

addSpecification	Specify known data types in a system
addTolerance	Specify numeric tolerance for optimized system
showSpecifications	Show specifications for a system
showTolerances	Show tolerances specified for a system

Copy Semantics

Handle. To learn how handle classes affect copy operations, see Copying Objects.

Examples

Create an fxpOptimizationOptions object with default values

Create an fxpOptimizationObject with default property values.

```
options = fxpOptimizationOptions();
```

Edit the properties after creation using dot syntax.

```
options.Patience = 15;
options.AllowableWordLengths = [8,16,32]

options =
  fxpOptimizationOptions with properties:

        MaxIterations: 50
           MaxTime: 600
            Patience: 15
           Verbosity: High
  AllowableWordLengths: [8 16 32]
    ObjectiveFunction: BitWidthSum
           UseParallel: 0

Advanced Options
  AdvancedOptions: [1x1 DataTypeOptimization.AdvancedFxpOptimizationOptions]
```

See Also

Classes

OptimizationResult | OptimizationSolution

Functions

addTolerance | explore | fxpopt | showTolerances

Topics

“Optimize Fixed-Point Data Types for a System”

Introduced in R2018a

OptimizationResult class

Result after optimizing fixed-point system

Description

An `OptimizationResult` object contains the results after optimizing a fixed-point system. If the optimization process succeeds in finding a new fixed-point implementation, you can use this object to explore the different implementations that met the specified tolerances found during the process. Use the `explore` method to open the Simulation Data Inspector and view the behavior of the optimized system.

Construction

`result = fxpopt(model, sud, options)` optimizes the data types in the system specified by `sud` in the model, `model`, with additional options specified in the `fxpOptimizationOptions` object, `options`.

Input Arguments

model — Model containing system under design

character vector

Name of the model containing the system that you want to optimize.

Data Types: char

sud — System whose data types you want to optimize

character vector

System whose data types you want to optimize, specified as a character vector containing the path to the system.

Data Types: char

options — Additional optimization options

`fxpOptimizationOptions` object

`fxpOptimizationOptions` object specifying additional options to use during the data type optimization process.

Properties

FinalOutcome — Message specifying whether a new optimal solution was found

character vector

Message specifying whether the optimization process found a new optimal solution, returned as a character vector.

Data Types: char

OptimizationOptions — fxpOptimizationOptions object associated with the result`fxpOptimizationOptions` object

The `fxpOptimizationOptions` object used as an input to the `fxpopt` function used to generate the `OptimizationResult`.

Solutions — Vector of OptimizationSolution objects`OptimizationSolution` object | vector of `OptimizationSolution` objects

A vector of `OptimizationSolution` objects found during the optimization process. If the optimization finds a feasible solution, the vector is sorted by cost, with the lowest cost (most optimal) solution as the first element of the vector. If the optimization does not find a feasible solution, the vector is sorted by maximum difference from the original design.

Methods

<code>explore</code>	Explore fixed-point implementations found during optimization process
<code>revert</code>	Revert system data types and settings changed during optimization to original state
<code>openSimulationManager</code>	Inspect simulations run during optimization in Simulation Manager

Copy Semantics

Handle. To learn how handle classes affect copy operations, see [Copying Objects](#).

See Also**Classes**`OptimizationSolution` | `fxpOptimizationOptions`**Functions**`addTolerance` | `explore` | `fxpopt` | `showTolerances`**Topics**[“Optimize Fixed-Point Data Types for a System”](#)**Introduced in R2018a**

OptimizationSolution class

Optimized fixed-point implementation of system

Description

An `OptimizationSolution` object is a fixed-point implementation of a system whose data types were optimized using the `fxpopt` function.

Construction

`solution = explore(result)` opens the Simulation Data Inspector. If the optimization found a solution, it returns the `OptimizationSolution` object with the lowest cost out of the vector of `OptimizationSolution` objects contained in the `OptimizationResult` object, `result`. If the optimization did not find a solution, it returns the `OptimizationSolution` object with the smallest `MaxDifference`.

You can also access a `OptimizationSolution` object by indexing the `Solutions` property of an `OptimizationResult` object. For example, to access the solution with the second lowest cost contained in the `OptimizationResult` object, `result`, enter

```
solution = result.Solutions(2)
```

Input Arguments

result — OptimizationResult containing the solution

`OptimizationResult` object

The `Solutions` property of the `OptimizationResult` object is a vector of `OptimizationSolution` objects found during the optimization process. If the optimization found a feasible solution, the vector is sorted by cost, with the lowest cost (most optimal) solution as the first element of the vector. If the optimization did not find a feasible solution, the vector is sorted by `MaxDifference`, with the solution with the smallest `MaxDifference` as the first element.

Properties

Cost — Sum of word lengths used in the system under design

scalar integer

Sum of all word lengths used in the solution in the system under design. The most optimal solution is the solution with the smallest cost.

Data Types: `double`

Pass — Whether the solution meets specified criteria

1 | 0

Whether the solution meets the criteria specified by the associated `fxpOptimizationOptions` object, specified as a logical.

Data Types: `logical`

MaxDifference — Maximum absolute difference between baseline solution run

scalar

The maximum absolute difference between the baseline the solution.

Data Types: double

RunID — Run identifier

scalar integer

Unique numerical identification for the run used by the Simulation Data Inspector. For more information, see “Inspect and Compare Data Programmatically”.

Data Types: double

RunName — Name of the run

character vector

Name of the run in Simulation Data Inspector.

Data Types: char

Methods

showContents Get summary of changes made during data type optimization

Copy Semantics

Handle. To learn how handle classes affect copy operations, see Copying Objects.

See Also**Classes**

OptimizationResult | fxpOptimizationOptions

Functions

addTolerance | explore | fxpopt | showTolerances

Topics

“Optimize Fixed-Point Data Types for a System”

Introduced in R2018a

Methods

isHeterogeneous

Class: coder.CellType

Package: coder

Determine whether cell array type represents a heterogeneous cell array

Syntax

```
tf = isHeterogeneous(t)
```

Description

`tf = isHeterogeneous(t)` returns `true` if the `coder.CellType` object `t` is heterogeneous. Otherwise, it returns `false`.

Examples

Determine Whether Cell Array Type Is Heterogeneous

Create a `coder.CellType` object for a cell array whose elements have different classes.

```
t = coder.typeof({'a', 1})
```

```
t =
```

```
coder.CellType
  1x2 heterogeneous cell
    f0: 1x1 char
    f1: 1x1 double
```

Determine whether the `coder.CellType` object represents a heterogeneous cell array.

```
isHeterogeneous(t)
```

```
ans =
```

```
    1
```

Tips

- `coder.typeof` determines whether the cell array type is homogeneous or heterogeneous. If the cell array elements have the same class and size, `coder.typeof` returns a homogeneous cell array type. If the elements have different classes, `coder.typeof` returns a heterogeneous cell array type. For some cell arrays, the classification as homogeneous or heterogeneous is ambiguous. For example, the type for `{1 [2 3]}` can be a `1x2` heterogeneous type. The first element is `double` and the second element is `1x2 double`. The type can also be a `1x3` homogeneous type in which the elements have class `double` and size `1x2`. For these ambiguous cases, `coder.typeof` uses heuristics to classify the type as homogeneous or heterogeneous. If you want a different classification, use the `makeHomogeneous` or `makeHeterogeneous` methods. The

`makeHomogeneous` method makes a homogeneous copy of a type. The `makeHeterogeneous` method makes a heterogeneous copy of a type.

The `makeHomogeneous` and `makeHeterogeneous` methods permanently assign the classification as homogeneous and heterogeneous, respectively. You cannot later use one of these methods to create a copy that has a different classification.

See Also

`coder.newtype` | `coder.typeof`

Topics

“Code Generation for Cell Arrays”

“Specify Cell Array Inputs at the Command Line”

Introduced in R2015b

isHomogeneous

Class: coder.CellType

Package: coder

Determine whether cell array type represents a homogeneous cell array

Syntax

```
tf = isHomogeneous(t)
```

Description

`tf = isHomogeneous(t)` returns `true` if the `coder.CellType` object `t` represents a homogeneous cell array. Otherwise, it returns `false`.

Examples

Determine Whether Cell Array Type Is Homogeneous.

Create a `coder.CellType` object for a cell array whose elements have the same class and size.

```
t = coder.typeof({1 2 3})
```

```
t =
```

```
coder.CellType  
  1x3 homogeneous cell  
  base: 1x1 double
```

Determine whether the `coder.CellType` object represents a homogeneous cell array.

```
isHomogeneous(t)
```

```
ans =
```

```
  1
```

Test for a Homogeneous Cell Array Type Before Executing Code

Write a function `make_varsize`. If the input type `t` is homogeneous, the function returns a variable-size copy of `t`.

```
function c = make_varsize(t, n)  
assert(isHomogeneous(t));  
c = coder.typeof(t, [n n], [1 1]);  
end
```

Create a heterogeneous type `tc`.

```
tc = coder.typeof({'a', 1});
```

Pass `tc` to `make_varsize`.

```
tc1 = make_varsize(tc, 5)
```

The assertion fails because `tc` is heterogeneous.

Create a homogeneous type `tc`.

```
tc = coder.typeof({1 2 3});
```

Pass `tc` to `make_varsize`.

```
tc1 = make_varsize(tc, 5)
```

```
tc1 =
```

```
coder.CellType
  :5x:5 homogeneous cell
  base: 1x1 double
```

Tips

- `coder.typeof` determines whether the cell array type is homogeneous or heterogeneous. If the cell array elements have the same class and size, `coder.typeof` returns a homogeneous cell array type. If the elements have different classes, `coder.typeof` returns a heterogeneous cell array type. For some cell arrays, the classification as homogeneous or heterogeneous is ambiguous. For example, the type for `{1 [2 3]}` can be a 1x2 heterogeneous type. The first element is double and the second element is 1x2 double. The type can also be a 1x3 homogeneous type in which the elements have class double and size 1x:2. For these ambiguous cases, `coder.typeof` uses heuristics to classify the type as homogeneous or heterogeneous. If you want a different classification, use the `makeHomogeneous` or `makeHeterogeneous` methods. The `makeHomogeneous` method makes a homogeneous copy of a type. The `makeHeterogeneous` method makes a heterogeneous copy of a type.

The `makeHomogeneous` and `makeHeterogeneous` methods permanently assign the classification as homogeneous and heterogeneous, respectively. You cannot later use one of these methods to create a copy that has a different classification.

See Also

`coder.newtype` | `coder.typeof`

Topics

“Code Generation for Cell Arrays”

“Specify Cell Array Inputs at the Command Line”

Introduced in R2015b

makeHeterogeneous

Class: `coder.CellType`

Package: `coder`

Make a heterogeneous copy of a cell array type

Syntax

```
newt = makeHeterogeneous(t)
```

```
t = makeHeterogeneous(t)
```

Description

`newt = makeHeterogeneous(t)` creates a `coder.CellType` object for a heterogeneous cell array from the `coder.CellType` object `t`. `t` cannot represent a variable-size cell array.

The classification as heterogeneous is permanent. You cannot later create a homogeneous `coder.CellType` object from `newt`.

`t = makeHeterogeneous(t)` creates a heterogeneous `coder.CellType` object from `t` and replaces `t` with the new object.

Examples

Replace a Homogeneous Cell Array Type with a Heterogeneous Cell Array Type

Create a cell array type `t` whose elements have the same class and size.

```
t = coder.typeof({1 2 3})
```

```
t =
```

```
coder.CellType  
  1x3 homogeneous cell  
  base: 1x1 double
```

The cell array type is homogeneous.

Replace `t` with a cell array type for a heterogeneous cell array.

```
t = makeHeterogeneous(t)
```

```
t =
```

```
coder.CellType  
  1x3 locked heterogeneous cell  
  f1: 1x1 double  
  f2: 1x1 double  
  f3: 1x1 doublee
```

The cell array type is heterogeneous. The elements have the size and class of the original homogeneous cell array type.

Tips

- In the display of a `coder.CellType` object, the terms `locked heterogeneous` or `locked homogeneous` indicate that the classification as homogeneous or heterogeneous is permanent. You cannot later change the classification by using the `makeHomogeneous` or `makeHeterogeneous` methods.
- `coder.typeof` determines whether the cell array type is homogeneous or heterogeneous. If the cell array elements have the same class and size, `coder.typeof` returns a homogeneous cell array type. If the elements have different classes, `coder.typeof` returns a heterogeneous cell array type. For some cell arrays, the classification as homogeneous or heterogeneous is ambiguous. For example, the type for `{1 [2 3]}` can be a 1x2 heterogeneous type. The first element is double and the second element is 1x2 double. The type can also be a 1x3 homogeneous type in which the elements have class double and size 1x:2. For these ambiguous cases, `coder.typeof` uses heuristics to classify the type as homogeneous or heterogeneous. If you want a different classification, use the `makeHomogeneous` or `makeHeterogeneous` methods.

See Also

`coder.newtype` | `coder.typeof`

Topics

“Code Generation for Cell Arrays”

“Specify Cell Array Inputs at the Command Line”

Introduced in R2015b

makeHomogeneous

Class: `coder.CellType`

Package: `coder`

Create a homogeneous copy of a cell array type

Syntax

```
newt = makeHomogeneous(t)
t = makeHomogeneous(t)
```

Description

`newt = makeHomogeneous(t)` creates a `coder.CellType` object for a homogeneous cell array `newt` from the `coder.CellType` object `t`.

To create `newt`, the `makeHomogeneous` method must determine a size and class that represent all elements of `t`:

- If the elements of `t` have the same class, but different sizes, the elements of `newt` are variable size with upper bounds that accommodate the elements of `t`.
- If the elements of `t` have different classes, for example, `char` and `double`, the `makeHomogeneous` method cannot create a `coder.CellType` object for a homogeneous cell array.

The classification as homogeneous is permanent. You cannot later create a heterogeneous `coder.CellType` object from `newt`.

`t = makeHomogeneous(t)` creates a homogeneous `coder.CellType` object from `t` and replaces `t` with the new object.

Examples

Replace a Heterogeneous Cell Array Type with a Homogeneous Cell Array Type

Create a cell array type `t` whose elements have the same class, but different sizes.

```
t = coder.typeof({1 [2 3]})
```

```
t =
```

```
coder.CellType
  1x2 heterogeneous cell
    f0: 1x1 double
    f1: 1x2 double
```

The cell array type is heterogeneous.

Replace `t` with a cell array type for a homogeneous cell array.

```
t = makeHomogeneous(t)
t =
coder.CellType
  1x2 locked homogeneous cell
  base: 1x:2 double
```

The new cell array type is homogeneous.

Tips

- In the display of a `coder.CellType` object, the terms `locked heterogeneous` or `locked homogeneous` indicate that the classification as homogeneous or heterogeneous is permanent. You cannot later change the classification by using the `makeHomogeneous` or `makeHeterogeneous` methods.
- `coder.typeof` determines whether the cell array type is homogeneous or heterogeneous. If the cell array elements have the same class and size, `coder.typeof` returns a homogeneous cell array type. If the elements have different classes, `coder.typeof` returns a heterogeneous cell array type. For some cell arrays, the classification as homogeneous or heterogeneous is ambiguous. For example, the type for `{1 [2 3]}` can be a 1x2 heterogeneous type. The first element is double and the second element is 1x2 double. The type can also be a 1x3 homogeneous type in which the elements have class double and size 1x:2. For these ambiguous cases, `coder.typeof` uses heuristics to classify the type as homogeneous or heterogeneous. If you want a different classification, use the `makeHomogeneous` or `makeHeterogeneous` methods.

See Also

`coder.newtype` | `coder.typeof`

Topics

“Code Generation for Cell Arrays”

“Specify Cell Array Inputs at the Command Line”

Introduced in R2015b

addApproximation

Replace floating-point function with lookup table during fixed-point conversion

Syntax

```
addApproximation(approximationObject)
```

Description

`addApproximation(approximationObject)` specifies a lookup table replacement in a `coder.FixptConfig` object. During floating-point to fixed-point conversion, the conversion process generates a lookup table approximation for the function specified in the `approximationObject`.

Input Arguments

approximationObject — Function replacement configuration object

`coder.mathfcngenerator.LookupTable` configuration object

Function replacement configuration object that specifies how to create an approximation for a MATLAB function. Use the `coder.FixptConfig` configuration object `addApproximation` method to associate this configuration object with a `coder.FixptConfig` object. Then use the `fiaccel` function `-float2fixed` option with `coder.FixptConfig` to convert floating-point MATLAB code to fixed-point MATLAB code.

Examples

Replace log function with an optimized lookup table replacement

Create a function replacement configuration object that specifies to replace the log function with an optimized lookup table.

```
logAppx = coder.approximation('Function','log','OptimizeLUTSize',...
    true,'InputRange',[0.1,1000],'InterpolationDegree',1,...
    'ErrorThreshold',1e-3,...
    'FunctionNamePrefix','log_optim_', 'OptimizeIterations',25);
```

Create a fixed-point configuration object and associate the function replacement configuration object with it.

```
fixptcfg = coder.config('fixpt');
fixptcfg.addApproximation(logAppx);
```

You can now generate fixed-point code using the `fiaccel` function.

See Also

`coder.FixPtConfig` | `fiaccel`

Topics

“Replace the exp Function with a Lookup Table”

“Replace a Custom Function with a Lookup Table”
“Replacing Functions Using Lookup Table Approximations”

addDesignRangeSpecification

Add design range specification to parameter

Syntax

```
addDesignRangeSpecification(fcnName,paramName,designMin, designMax)
```

Description

`addDesignRangeSpecification(fcnName,paramName,designMin, designMax)` specifies the minimum and maximum values allowed for the parameter, `paramName`, in function, `fcnName`. The fixed-point conversion process uses this design range information to derive ranges for downstream variables in the code.

Input Arguments

fcnName — Function name

string

Function name, specified as a string.

Data Types: char

paramName — Parameter name

string

Parameter name, specified as a string.

Data Types: char

designMin — Minimum value allowed for this parameter

scalar

Minimum value allowed for this parameter, specified as a scalar double.

Data Types: double

designMax — Maximum value allowed for this parameter

scalar

Maximum value allowed for this parameter, specified as a scalar double.

Data Types: double

Examples

Add a Design Range Specification

```
% Set up the fixed-point configuration object
cfg = coder.config('fixpt');
cfg.TestBenchName = 'dti_test';
cfg.addDesignRangeSpecification('dti', 'u_in', -1.0, 1.0)
```



```
cfg.ComputeDerivedRanges = true;  
  
% Derive ranges and generate fixed-point code  
fiaccel -float2fixed cfg dti
```

See Also

```
clearDesignRangeSpecifications | coder.FixPtConfig | fiaccel |  
getDesignRangeSpecification | hasDesignRangeSpecification |  
removeDesignRangeSpecification
```

addFunctionReplacement

Replace floating-point function with fixed-point function during fixed-point conversion

Syntax

```
addFunctionReplacement(floatFn, fixedFn)
```

Description

`addFunctionReplacement(floatFn, fixedFn)` specifies a function replacement in a `coder.FixptConfig` object. During floating-point to fixed-point conversion, the conversion process replaces the specified floating-point function with the specified fixed-point function. The fixed-point function must be in the same folder as the floating-point function or on the MATLAB path.

Input Arguments

floatFn — Name of floating-point function

' ' (default) | string

Name of floating-point function, specified as a string.

fixedFn — Name of fixed-point function

' ' (default) | string

Name of fixed-point function, specified as a string.

Examples

Specify Function Replacement in Fixed-Point Conversion Configuration Object

Suppose that:

- The function `myfunc` calls a local function `myadd`.
- The test function `mytest` calls `myfunc`.
- You want to replace calls to `myadd` with the fixed-point function `fi_myadd`.

Create a `coder.FixptConfig` object, `fixptcfg`, with default settings.

```
fixptcfg = coder.config('fixpt');
```

Set the test bench name. In this example, the test bench function name is `mytest`.

```
fixptcfg.TestBenchName = 'mytest';
```

Specify that the floating-point function, `myadd`, should be replaced with the fixed-point function, `fi_myadd`.

```
fixptcfg.addFunctionReplacement('myadd', 'fi_myadd');
```

Convert the floating-point MATLAB function, `myfunc`, to fixed-point.

```
fiaccel -float2fixed fixptcfg myfunc
```

`fiaccel` replaces `myadd` with `fi_myadd` during floating-point to fixed-point conversion.

See Also

`coder.FixPtConfig` | `fiaccel`

addFunctionReplacement

Class: `coder.SingleConfig`

Package: `coder`

Replace double-precision function with single-precision function during single-precision conversion

Syntax

```
addFunctionReplacement(doubleFn, singleFn)
```

Description

`addFunctionReplacement(doubleFn, singleFn)` specifies a function replacement in a `coder.SingleConfig` object. During double-precision to single-precision conversion, the conversion process replaces the specified double-precision function with the specified single-precision function. The single-precision function must be in the same folder as the double-precision function or on the MATLAB path. It is a best practice to provide unique names to local functions that a replacement function calls. If a replacement function calls a local function, do not give that local function the same name as a local function in a different replacement function file.

Input Arguments

doubleFn — Name of double-precision function

' ' (default) | string

Name of double-precision function, specified as a string.

singleFn — Name of single-precision function

' ' (default) | string

Name of single-precision function, specified as a string.

Examples

Specify Function Replacement in Single-Precision Conversion Configuration Object

Suppose that:

- The function `myfunc` calls a local function `myadd`.
- The test function `mytest` calls `myfunc`.
- You want to replace calls to `myadd` with the single-precision function `single_myadd`.

Create a `coder.SingleConfig` object, `scfg`, with default settings.

```
scfg = coder.config('single');
```

Set the test file name. In this example, the test file function name is `mytest`.

```
scfg.TestBenchName = 'mytest';
```

Specify that you want to replace the double-precision function, `myadd`, with the single-precision function, `single_myadd`.

```
scfg.addFunctionReplacement('myadd', 'single_myadd');
```

Convert the double-precision MATLAB function, `myfunc` to a single-precision MATLAB function.

```
convertToSingle -config scfg myfunc
```

The double-precision to single-precision conversion replaces instances of `myadd` with `single_myadd`.

See Also

Introduced in R2015b

clearDesignRangeSpecifications

Clear all design range specifications

Syntax

```
clearDesignRangeSpecifications()
```

Description

`clearDesignRangeSpecifications()` clears all design range specifications.

Examples

Clear a Design Range Specification

```
% Set up the fixed-point configuration object
cfg = coder.config('fixpt');
cfg.TestBenchName = 'dti_test';
cfg.addDesignRangeSpecification('dti', 'u_in', -1.0, 1.0)
cfg.ComputeDerivedRanges = true;
% Verify that the 'dti' function parameter 'u_in' has design range
hasDesignRanges = cfg.hasDesignRangeSpecification('dti','u_in')
% Now remove the design range
cfg.clearDesignRangeSpecifications()
hasDesignRanges = cfg.hasDesignRangeSpecification('dti','u_in')
```

See Also

`addDesignRangeSpecification` | `coder.FixPtConfig` | `fiaccel` |
`getDesignRangeSpecification` | `hasDesignRangeSpecification` |
`removeDesignRangeSpecification`

getDesignRangeSpecification

Get design range specifications for parameter

Syntax

```
[designMin, designMax] = getDesignRangeSpecification(fcnName,paramName)
```

Description

[designMin, designMax] = getDesignRangeSpecification(fcnName,paramName) gets the minimum and maximum values specified for the parameter, paramName, in function, fcnName.

Input Arguments

fcnName — Function name

string

Function name, specified as a string.

Data Types: char

paramName — Parameter name

string

Parameter name, specified as a string.

Data Types: char

Output Arguments

designMin — Minimum value allowed for this parameter

scalar

Minimum value allowed for this parameter, specified as a scalar double.

Data Types: double

designMax — Maximum value allowed for this parameter

scalar

Maximum value allowed for this parameter, specified as a scalar double.

Data Types: double

Examples

Get Design Range Specifications

```
% Set up the fixed-point configuration object  
cfg = coder.config('fixpt');  
cfg.TestBenchName = 'dti_test';
```

```
cfg.addDesignRangeSpecification('dti', 'u_in', -1.0, 1.0)
cfg.ComputeDerivedRanges = true;
% Get the design range for the 'dti' function parameter 'u_in'
[designMin, designMax] = cfg.getDesignRangeSpecification('dti','u_in')

designMin =
    -1

designMax =
     1
```

See Also

[addDesignRangeSpecification](#) | [clearDesignRangeSpecifications](#) | [coder.FixPtConfig](#)
| [fiaccl](#) | [hasDesignRangeSpecification](#) | [removeDesignRangeSpecification](#)

hasDesignRangeSpecification

Determine whether parameter has design range

Syntax

```
hasDesignRange = hasDesignRangeSpecification(fcnName,paramName)
```

Description

`hasDesignRange = hasDesignRangeSpecification(fcnName,paramName)` returns true if the parameter, `param_name` in function, `fcn`, has a design range specified.

Input Arguments

fcnName — Name of function

string

Function name, specified as a string.

Example: 'dti'

Data Types: char

paramName — Parameter name

string

Parameter name, specified as a string.

Example: 'dti'

Data Types: char

Output Arguments

hasDesignRange — Parameter has design range

true | false

Parameter has design range, returned as a boolean.

Data Types: logical

Examples

Verify That a Parameter Has a Design Range Specification

```
% Set up the fixed-point configuration object
cfg = coder.config('fixpt');
cfg.TestBenchName = 'dti_test';
cfg.addDesignRangeSpecification('dti', 'u_in', -1.0, 1.0);
cfg.ComputeDerivedRanges = true;
% Verify that the 'dti' function parameter 'u_in' has design range
hasDesignRanges = cfg.hasDesignRangeSpecification('dti','u_in')
```

```
hasDesignRanges =
```

```
    1
```

See Also

`addDesignRangeSpecification` | `clearDesignRangeSpecifications` | `coder.FixPtConfig`
| `fiaccel` | `getDesignRangeSpecification` | `removeDesignRangeSpecification`

removeDesignRangeSpecification

Remove design range specification from parameter

Syntax

```
removeDesignRangeSpecification(fcnName,paramName)
```

Description

`removeDesignRangeSpecification(fcnName,paramName)` removes the design range information specified for parameter, `paramName`, in function, `fcnName`.

Input Arguments

fcnName — Name of function

string

Function name, specified as a string.

Data Types: char

paramName — Parameter name

string

Parameter name, specified as a string.

Data Types: char

Examples

Remove Design Range Specifications

```
% Set up the fixed-point configuration object
cfg = coder.config('fixpt');
cfg.TestBenchName = 'dti_test';
cfg.addDesignRangeSpecification('dti', 'u_in', -1.0, 1.0)
cfg.ComputeDerivedRanges = true;
% Verify that the 'dti' function parameter 'u_in' has design range
hasDesignRanges = cfg.hasDesignRangeSpecification('dti','u_in')
% Now clear the design ranges and verify that
% hasDesignRangeSpecification returns false
cfg.removeDesignRangeSpecification('dti', 'u_in')
hasDesignRanges = cfg.hasDesignRangeSpecification('dti','u_in')
```

See Also

`addDesignRangeSpecification` | `clearDesignRangeSpecifications` | `coder.FixPtConfig` | `fiaccel` | `getDesignRangeSpecification` | `hasDesignRangeSpecification`

applyDataTypes

Package: DataTypeWorkflow

Apply proposed data types to model

Syntax

```
applyDataTypes( converter , RunName )
```

Description

`applyDataTypes(converter , RunName)` applies the proposed data types for the specified run, `RunName`, to the system specified by the `converter` object.

Input Arguments

converter — Converter object

`DataTypeWorkflow.Converter` object

Converter object for the system under design, specified as a `DataTypeWorkflow.Converter` object.

RunName — Name of run to apply data types to

character vector

Name of run to apply data types to, specified as a character vector.

Example: `applyDataTypes(converter , 'Run1')`

Data Types: char

Alternatives

The `applyDataTypes` object function provides functionality similar to the Fixed-Point Tool button

Apply Data Types . For more information, see Fixed-Point Tool.

See Also

`DataTypeWorkflow.ProposalSettings` | `proposeDataTypes`

Topics

“Convert a Model to Fixed Point Using the Command Line”

Introduced in R2014b

applySettingsFromRun

Package: DataTypeWorkflow

Apply system settings used in previous run to model

Syntax

```
applySettingsFromRun(converter, RunName)
```

Description

`applySettingsFromRun(converter, RunName)` applies the data type override and instrumentation settings used in a previous run, `RunName`, to the model specified in the `converter` object.

Input Arguments

converter — Converter object

`DataTypeWorkflow.Converter` object

Converter object for the system under design, specified as a `DataTypeWorkflow.Converter` object.

RunName — Name of run

character vector

Name of run from which to apply settings, specified as a character vector.

Example: `applySettingsFromRun(converter, 'Run1')`

Data Types: char

See Also

`DataTypeWorkflow.Converter` | `applySettingsFromShortcut`

Topics

“Convert a Model to Fixed Point Using the Command Line”

Introduced in R2014b

applySettingsFromShortcut

Package: DataTypeWorkflow

Apply settings from shortcut to model

Syntax

```
applySettingsFromShortcut(converter, shortcutName)
```

Description

`applySettingsFromShortcut(converter, shortcutName)` applies settings from the specified system shortcut, `shortcutName`, to a `converter` object.

Examples

Configure Model for Conversion Using a Shortcut

This example shows how to configure a model for fixed-point conversion using a shortcut.

Open the `fxpdemo_feedback` model.

```
open_system('fxpdemo_feedback');
```

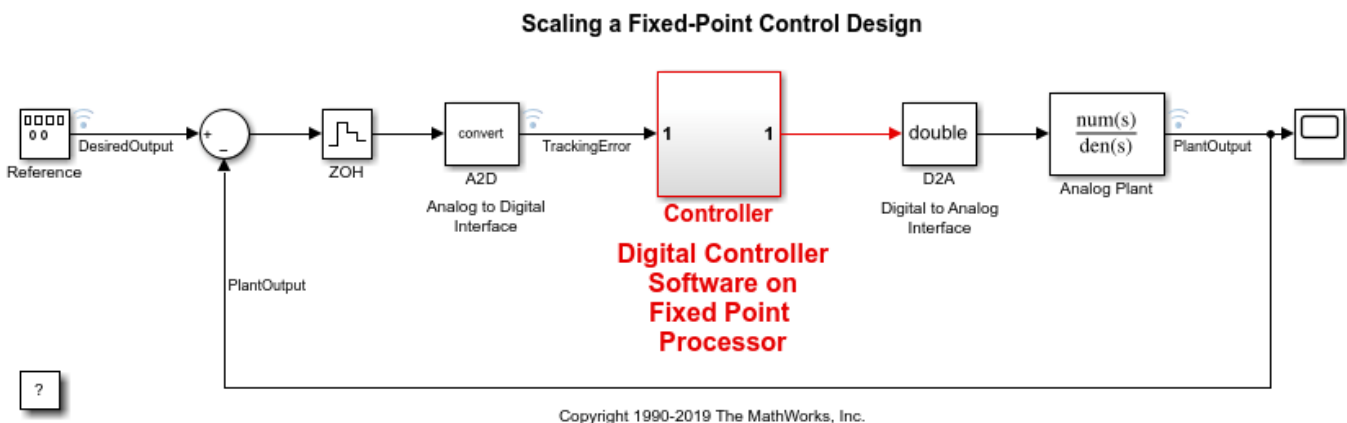

Create a `DataTypeWorkflow.Converter` object for the Controller subsystem.

```
converter = DataTypeWorkflow.Converter('fxpdemo_feedback/Controller');
```

Configure the model for conversion by using a shortcut. Find the shortcuts that are available for the system by accessing the `ShortcutsForSelectedSystem` property of the `converter` object.

```
shortcuts = converter.ShortcutsForSelectedSystem
```

```
shortcuts =
```

6x1 cell array

```
{'Range collection using double override'      }
{'Range collection with specified data types'  }
{'Range collection using single override'      }
{'Disable range collection'                   }
{'Remove overrides and disable range collection'}
{'Range collection using scaled double override'}
```

To collect idealized ranges for the system, use the 'Range collection using double override' shortcut to override the system with double-precision data types and enable instrumentation.

```
applySettingsFromShortcut(converter,shortcuts{1})
```

This shortcut also updates the current run name property of the converter object.

```
converter.CurrentRunName
```

```
ans =
```

```
    'Ranges(Double)'
```

Input Arguments

converter — Converter object

`DataTypeWorkflow.Converter` object

Converter object for the system under design, specified as a `DataTypeWorkflow.Converter` object.

shortcutName — Name of shortcut

character vector

Name of the shortcut that specifies which settings to use, specified as a character vector.

Example: `applySettingsFromShortcut(converter,'Range collection using double override')`

Data Types: char

See Also

`DataTypeWorkflow.Converter` | `applySettingsFromRun`

Topics

“Convert a Model to Fixed Point Using the Command Line”

Introduced in R2014b

deriveMinMax

Package: DataTypeWorkflow

Derive range information for model

Syntax

```
deriveMinMax(converter)
```

Description

`deriveMinMax(converter)` derives the minimum and maximum values for each block in the system specified by the `DataTypeWorkflow.Converter` object based on design minimum and maximum values.

Input Arguments

converter — Converter object for system under design

`DataTypeWorkflow.Converter` object

Converter object for the system under design, specified as a `DataTypeWorkflow.Converter` object.

Tips

If any issues come up during the derivation, they can be queried using the `proposalIssues` object function.

Alternatives

The `deriveMinMax` object function is equivalent to the **Collect Ranges** button () with **Range Collection Mode** set to **Derived Ranges** in the Fixed-Point Tool. For more information, see Fixed-Point Tool.

See Also

`DataTypeWorkflow.Converter` | `proposalIssues` | `simulateSystem`

Topics

“Convert a Model to Fixed Point Using the Command Line”

Introduced in R2014b

proposeDataTypes

Package: DataTypeWorkflow

Propose data types for system

Syntax

```
proposeDataTypes( converter, RunName, propSettings )
```

Description

proposeDataTypes(converter, RunName, propSettings) proposes data types for the system specified by the DataTypeWorkflow. Converter object, converter, based on the range results stored in RunName and the settings specified in propSettings.

Input Arguments

converter — Converter object

DataTypeWorkflow.Converter object

Converter object, specified as a DataTypeWorkflow.Converter object, for the system under design.

RunName — Name of run

character vector

Name of run to propose data types for, specified as a character vector.

Data Types: char

propSettings — Proposed data type settings

DataTypeWorkflow.ProposalSettings object

Proposed data type settings, specified as a DataTypeWorkflow.ProposalSettings object. Use this object to specify proposal settings such as the default data type for all floating point signals.

Data Types: char

Alternatives

The proposeDataTypes object function provides functionality similar to the Fixed-Point Tool

Propose Data Types  button. For more information, see Fixed-Point Tool.

See Also

DataTypeWorkflow.Converter | DataTypeWorkflow.ProposalSettings | applyDataTypes

Topics

“Convert a Model to Fixed Point Using the Command Line”

Introduced in R2014b

results

Package: DataTypeWorkflow

Find results for selected system in converter object

Syntax

```
results = results(converter,RunName)
results = results(converter,RunName,filterFunc)
```

Description

`results = results(converter,RunName)` returns all results in the specified run, for the model specified by the `DataTypeWorkflow.Converter` object, `converter`.

`results = results(converter,RunName,filterFunc)` returns the results in the specified run that match the criteria specified by `filterFunc`.

Input Arguments

converter — Converter object

`DataTypeWorkflow.Converter` object

Converter object for the system under design, specified as a `DataTypeWorkflow.Converter` object.

RunName — Name of run

character vector

Name of the run to query, specified as a character vector.

Data Types: `char`

filterFunc — Function to use to filter results

function handle

Function to use to filter results, specified as a function handle with a `DataTypeWorkflow.Result` object as its input.

Data Types: `function_handle`

Output Arguments

results — Filtered results

array of `Result` objects

Filtered results, returned as an array of `DataTypeWorkflow.Result` objects.

Alternatives

The `results` object function offers a command-line approach to using the Fixed-Point Tool. For more information, see [Fixed-Point Tool](#).

See Also

[DataTypeWorkflow.Converter](#) | [proposalIssues](#) | [saturationOverflows](#) | [wrapOverflows](#)

Topics

[“Convert a Model to Fixed Point Using the Command Line”](#)

Introduced in R2014b

proposalIssues

Package: `DataTypeWorkflow`

Get results which have comments associated with them

Syntax

```
results = proposalIssues(converter,RunName)
```

Description

`results = proposalIssues(converter,RunName)` returns all results in `RunName` for the model specified by a `DataTypeWorkflow.Converter` object, `converter`, that have associated comments. The `comments` field of the returned results provides information related to any issues found.

Input Arguments

converter — Converter object

`DataTypeWorkflow.Converter` object

Converter object for system under design, specified as a `DataTypeWorkflow.Converter` object.

RunName — Name of run

character vector

Name of the run to look for comments in, specified as a character vector.

Data Types: `char`

Output Arguments

results — Results that have associated comments

`DataTypeWorkflow.Result` object

Results that have associated comments, returned as a `DataTypeWorkflow.Result` object, for all signals in `RunName`.

Alternatives

The `DataTypeWorkflow.Converter.proposalIssues` object function offers a command-line approach to using the Fixed-Point Tool. See Fixed-Point Tool for more information.

See Also

`DataTypeWorkflow.Converter` | `results` | `saturationOverflows` | `wrapOverflows`

Topics

“Convert a Model to Fixed Point Using the Command Line”

Introduced in R2014b

saturationOverflows

Package: DataTypeWorkflow

Get results where saturation occurred

Syntax

```
results = saturationOverflows(converter,RunName)
```

Description

`results = saturationOverflows(converter,RunName)` returns all results in `RunName`, for the model specified by the `DataTypeWorkflow.Converter` object, `converter`, that saturated during simulation.

Examples

Get Saturation Results for Specified Run

This example shows how to get saturation results for the specified run of a `DataTypeWorkflow.Converter` object.

Open the `fxpdemo_feedback` model.

```
open_system('fxpdemo_feedback');
```

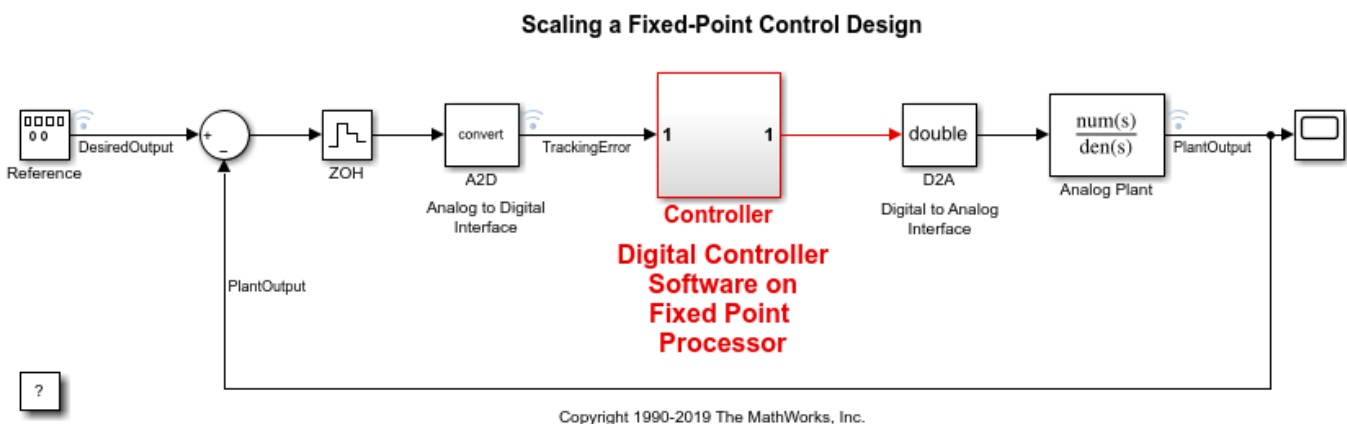

Create a `DataTypeWorkflow.Converter` object for the Controller subsystem.

```
converter = DataTypeWorkflow.Converter('fxpdemo_feedback/Controller');
```

Simulate the model and store the results in a run titled `InitialRun`.

```
converter.CurrentRunName = 'InitialRun';
simulateSystem(converter);
```

Determine if there were any overflows in the run.

```
saturations = saturationOverflows(converter, 'InitialRun')
```

```
saturations =
```

```
Result with properties:
```

```

    ResultName: 'fxpdemo_feedback/Controller/Up Cast'
SpecifiedDataType: 'fixdt(1,16,14)'
CompiledDataType: 'fixdt(1,16,14)'
ProposedDataType: ''
    Wraps: []
    Saturations: 23
    WholeNumber: 0
    SimMin: -2
    SimMax: 1.9999
    DerivedMin: []
    DerivedMax: []
    RunName: 'InitialRun'
    Comments: {'An output data type cannot be specified on this result. The output type
DesignMin: []
DesignMax: []

```

A saturation occurs in the Up Cast block of the Controller subsystem during the simulation. There are no wrapping overflows.

Input Arguments

converter — Converter object

`DataTypeWorkflow.Converter` object

Converter object for the system under design, specified as a `DataTypeWorkflow.Converter` object.

RunName — Name of run

character vector

Name of run to look for saturations in, specified as a character vector.

Example: `saturations = saturationOverflows(converter, 'Run 1')`

Data Types: char

Output Arguments

results — Results that saturated

`DataTypeWorkflow.Result` object

Results that saturated, returned as a `DataTypeWorkflow.Result` object.

See Also

`DataTypeWorkflow.Converter` | `proposalIssues` | `results` | `wrapOverflows`

Topics

“Convert a Model to Fixed Point Using the Command Line”

Introduced in R2014b

simulateSystem

Package: DataTypeWorkflow

Simulate system specified by converter object

Syntax

```
simOut = simulateSystem(converter)
simOut = simulateSystem(converter,Name,Value)
simOut = simulateSystem(converter,simIn)
simOut = simulateSystem(converter,ParameterStruct)
simOut = simulateSystem(converter,ConfigSet)
```

Description

`simOut = simulateSystem(converter)` simulates the system specified by the `DataTypeWorkflow.Converter` object, `converter`.

`simOut = simulateSystem(converter,Name,Value)` simulates the system specified by the `DataTypeWorkflow.Converter` object, `converter`, using additional options specified by one or more `Name,Value` pair arguments. This function accepts the same `Name,Value` pairs as the `sim` function.

`simOut = simulateSystem(converter,simIn)` simulates the system specified by the `DataTypeWorkflow.Converter` object, `converter`, using the inputs specified in the `Simulink.SimulationInput` object `simIn`.

`simOut = simulateSystem(converter,ParameterStruct)` simulates the system specified by the `DataTypeWorkflow.Converter` object, `converter`, using the parameter values specified in the structure, `ParameterStruct`.

`simOut = simulateSystem(converter,ConfigSet)` simulates the system specified by the `DataTypeWorkflow.Converter` object, `converter`, using the configuration settings specified in the model configuration set, `ConfigSet`.

Examples

Simulate a DataTypeWorkflow.Converter Object's System

This example shows how to simulate the converter object's system.

Open the `fxpdemo_feedback` model.

```
open_system('fxpdemo_feedback');
```

Scaling a Fixed-Point Control Design

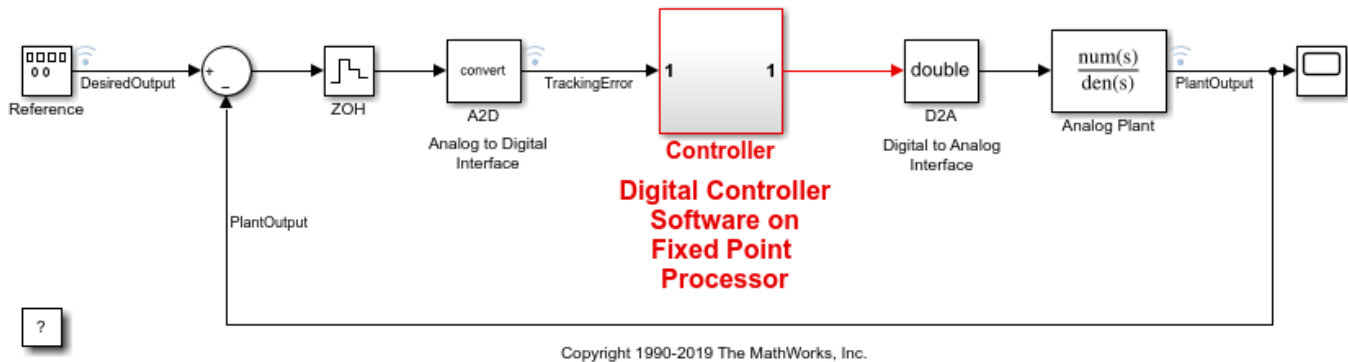

Create a `DataTypeWorkflow.Converter` object for the Controller subsystem.

```
converter = DataTypeWorkflow.Converter('fxpdemo_feedback/Controller');
```

Simulate the model.

```
simulateSystem(converter);
```

Input Arguments

converter — Converter object

`DataTypeWorkflow.Converter` object

Converter object for the system under design, specified as a `DataTypeWorkflow.Converter` object.

simIn — Simulation input for the system

`Simulink.SimulationInput` object | array of `Simulink.SimulationInput` objects

Simulation input for the system, specified as a `Simulink.SimulationInput` object or an array of `Simulink.SimulationInput` objects.

When you use a `SimulationInput` object as an input to the `simulateSystem` function, you can also specify the following `Name, Value` pair arguments.

Parameter	Values
<code>ShowSimulationManager</code>	<ul style="list-style-type: none"> 'on' - Opens the Simulation Manager. 'off' (default) - Does not open the Simulation Manager.
<code>ShowProgress</code>	<ul style="list-style-type: none"> 'on' - View the progress of the simulation in the command window. 'off' (default) - The progress of the simulation does not display in the command window.

ParameterStruct — Parameter settings

structure

Names of the configuration parameters for the simulation, specified as a structure. The corresponding values are the parameter values.

Data Types: `struct`

ConfigSet – Configuration set

`Simulink.ConfigSet` object

Configuration set, specified as a `Simulink.ConfigSet` object, that contains the values of the model parameters.

Output Arguments

simOut – Simulation output

`Simulink.SimulationOutput` object

Simulation output, returned as a `Simulink.SimulationOutput` object. The returned object includes the simulation outputs: logged time, states, and signals.

Tips

- To name your simulation run, before simulation, change the `CurrentRunName` property of the `DataTypeWorkflow.Converter` object.
- `simulateSystem` provides functionality similar to the `sim` command, except that `simulateSystem` preserves the model-wide data type override and instrumentation settings of each run.

Note

- The `SimulationMode` property must be set to `normal`. The Fixed-Point Designer software does collect simulation ranges in Rapid accelerator or Hot restart modes.
 - The `StopTime` property cannot be set to `inf`.
 - The `SrcWorkspace` parameter must be set to either `base` or `current`.
-

See Also

`DataTypeWorkflow.Converter` | `sim`

Topics

“Convert a Model to Fixed Point Using the Command Line”

Introduced in R2014b

verify

Package: `DataTypeWorkflow`

Compare behavior of baseline and autoscaled systems

Syntax

```
verificationResult = verify(converter,baselineRun,verificationRunName)
```

Description

`verificationResult = verify(converter,baselineRun,verificationRunName)` simulates the system specified by the `DataTypeWorkflow.Converter` object, `converter`, and stores the run information in a new run, `verificationRun`. It returns a `DataTypeWorkflow.VerificationResult` object that compares the baseline and verification runs.

Input Arguments

converter — Converter object for system to verify

`DataTypeWorkflow.Converter` object

Converter object for system to verify, specified as a `DataTypeWorkflow.Converter` object. The `DataTypeWorkflow.Converter` object contains instrumentation data from the baseline run, as well as the tolerances specified on the associated `DataTypeWorkflow.ProposalSettings` object. The software determines if the behavior of the verification run is acceptable using the tolerances specified on the `ProposalSettings` object.

baselineRun — Baseline run to compare against

character vector

Baseline run to compare against, specified as a character vector.

Data Types: `char` | `string`

verificationRunName — Name of the verification run to create

character vector

Name of the verification run to create during the embedded simulation, specified as a character vector.

Data Types: `char` | `string`

Output Arguments

verificationResult — Comparison of the baseline run and the verification run

`DataTypeWorkflow.VerificationResult` object

Comparison of the baseline run and the verification run, returned as a `DataTypeWorkflow.VerificationResult` object.

See Also

`DataTypeWorkflow.Converter` | `DataTypeWorkflow.ProposalSettings` |
`DataTypeWorkflow.VerificationResult`

Topics

“Convert a Model to Fixed Point Using the Command Line”

Introduced in R2019a

wrapOverflows

Package: DataTypeWorkflow

Get results where wrapping occurred

Syntax

```
results = wrapOverflows(converter,RunName)
```

Description

`results = wrapOverflows(converter,RunName)` returns all results in `RunName`, for the system specified by the `DataTypeWorkflow.Converter` object, `converter`, that wrapped during simulation.

Input Arguments

converter — Converter object

`DataTypeWorkflow.Converter` object

Converter object, specified as a `DataTypeWorkflow.Converter` object, for the system under design.

RunName — Name of run

character vector

Name of run in which to look for wrap overflows, specified as a character vector.

Example: `results = wrapOverflows(converter, 'Run3')`

Data Types: `char`

Output Arguments

results — Signals that wrapped during the specified run

`DataTypeWorkflow.Result` object

Signals that wrapped during the specified run, returned as a `DataTypeWorkflow.Result` object.

See Also

[proposalIssues](#) | [results](#) | [saturationOverflows](#)

Topics

“Convert a Model to Fixed Point Using the Command Line”

Introduced in R2014b

addTolerance

Package: DataTypeWorkflow

Specify numeric tolerance for converted system

Syntax

```
addTolerance(proposalSettings,block_path,port_index,tolerance_type,
tolerance_value)
```

Description

`addTolerance(proposalSettings,block_path,port_index,tolerance_type,tolerance_value)` adds numeric tolerance data to a `DataTypeWorkflow.ProposalSettings` object for the output signal specified by `block_path` and `port_index`, with the tolerance type specified by `tolerance_type` and value specified by `tolerance_value`.

Examples

Specify Signal Tolerances

This example shows how to apply and remove tolerances from signals in a system. In this example, you add tolerances to a `DataTypeWorkflow.proposalSettings` object, and then remove all tolerances from this object.

```
model = 'fxpdemo_feedback';
open_system(model);
```

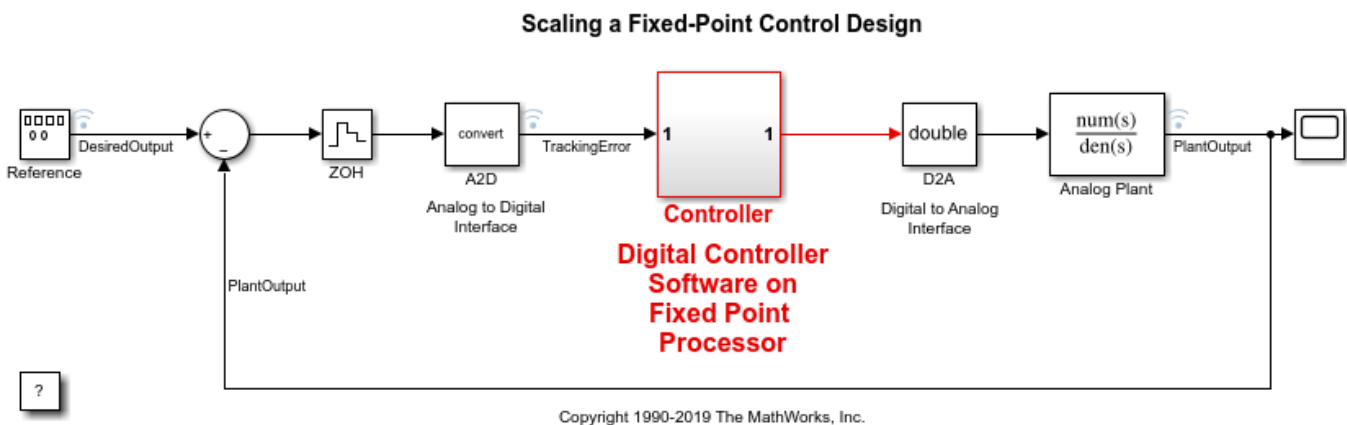

Create a `DataTypeWorkflow.ProposalSettings` object.

```
propSettings = DataTypeWorkflow.ProposalSettings;
```

Add an absolute tolerance of 0.05 to the output of the Down Cast block in the Controller subsystem.

```
addTolerance(propSettings, 'fxpdemo_feedback/Controller/Down Cast',1,'AbsTol',5e-2);
```

Add a relative tolerance of 1% to the same signal.

```
addTolerance(propSettings, 'fxpdemo_feedback/Controller/Down Cast',1,'RelTol',1e-2);
```

Use `showTolerances` to see all tolerances associated with the proposal settings object.

```
showTolerances(propSettings)
```

Path	Port_Index	Tolerance_Type	Tolerance_Value
{'fxpdemo_feedback/Controller/Down Cast'}	1	{'AbsTol'}	0.05
{'fxpdemo_feedback/Controller/Down Cast'}	1	{'RelTol'}	0.01

Clear the tolerances stored in the `ProposalSettings` object.

```
clearTolerances(propSettings)
```

Using `showTolerances`, verify that there are no longer any tolerances stored in the `ProposalSettings` object.

```
showTolerances(propSettings)
```

Input Arguments

proposalSettings — Object that contains proposal settings

`DataTypeWorkflow.ProposalSettings` object

Object that contains proposal settings, specified as a `DataTypeWorkflow.ProposalSettings` object. You add tolerance specifications to the `DataTypeWorkflow.ProposalSettings` object.

block_path — Path to block for which to add tolerance

character vector

Path to the block for which to add a tolerance to, specified as a character vector.

Data Types: `char` | `string`

port_index — Index of output port of block

scalar integer

Index of the output port of the blocks, specified as a scalar integer.

Data Types: `double`

tolerance_type — Type of tolerance

'AbsTol' | 'RelTol' | 'TimeTol'

Type of tolerance, specified as one of these values:

- 'AbsTol' - Absolute tolerance
- 'RelTol' - Relative tolerance
- 'TimeTol' - Time tolerance

Data Types: char

tolerance_value — **Acceptable difference between original output and output of new design**

scalar double

Acceptable difference between the original output and the output of the new design, specified as a scalar double.

If `tolerance_type` is set to 'AbsTol', then `tolerance_value` represents the absolute value of the maximum acceptable difference between the original output and the output of the new design.

If `tolerance_type` is set to 'RelTol', then `tolerance_value` represents the maximum relative difference, specified as a percentage, between the original output and the output of the new design. For example, a value of `1e-2` indicates a maximum difference of one percent between the original output and the output of the new design.

If `tolerance_type` is set to 'TimeTol', then `tolerance_value` defines a time interval, in seconds, in which the maximum and minimum values define the upper and lower values to compare against. For more information, see “How the Simulation Data Inspector Compares Data”.

Data Types: double

See Also

`DataTypeWorkflow.ProposalSettings` | `clearTolerances` | `showTolerances`

Topics

“Convert a Model to Fixed Point Using the Command Line”

“The Command-Line Interface for the Fixed-Point Tool”

Introduced in R2019a

clearTolerances

Package: DataTypeWorkflow

Clear all tolerances specified by a `DataTypeWorkflow.ProposalSettings` object

Syntax

```
clearTolerances(proposalSettings)
```

Description

`clearTolerances(proposalSettings)` clears the absolute, relative, and time tolerances of a `proposalSettings` object.

Examples

Specify Signal Tolerances

This example shows how to apply and remove tolerances from signals in a system. In this example, you add tolerances to a `DataTypeWorkflow.proposalSettings` object, and then remove all tolerances from this object.

```
model = 'fxpdemo_feedback';
open_system(model);
```

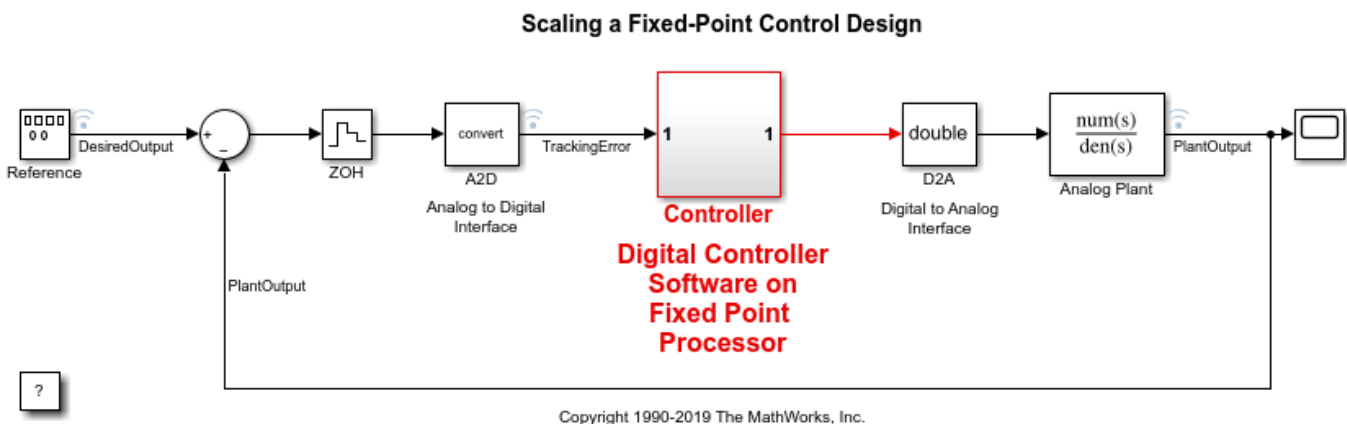

Create a `DataTypeWorkflow.ProposalSettings` object.

```
propSettings = DataTypeWorkflow.ProposalSettings;
```

Add an absolute tolerance of 0.05 to the output of the Down Cast block in the Controller subsystem.

```
addTolerance(propSettings, 'fxpdemo_feedback/Controller/Down Cast', 1, 'AbsTol', 5e-2);
```

Add a relative tolerance of 1% to the same signal.

```
addTolerance(propSettings, 'fxpdemo_feedback/Controller/Down Cast',1,'RelTol',1e-2);
```

Use `showTolerances` to see all tolerances associated with the proposal settings object.

```
showTolerances(propSettings)
```

Path	Port_Index	Tolerance_Type	Tolerance_Value
{'fxpdemo_feedback/Controller/Down Cast'}	1	{'AbsTol'}	0.05
{'fxpdemo_feedback/Controller/Down Cast'}	1	{'RelTol'}	0.01

Clear the tolerances stored in the `ProposalSettings` object.

```
clearTolerances(propSettings)
```

Using `showTolerances`, verify that there are no longer any tolerances stored in the `ProposalSettings` object.

```
showTolerances(propSettings)
```

Input Arguments

proposalSettings — Object that contains proposal settings

`DataTypeWorkflow.ProposalSettings` object

Object that contains proposal settings, specified as a `DataTypeWorkflow.ProposalSettings` object. A `DataTypeWorkflow.ProposalSettings` object specifies tolerances and settings to use during the data type proposal process.

See Also

`DataTypeWorkflow.ProposalSettings` | `addTolerance` | `showTolerances`

Topics

“Convert a Model to Fixed Point Using the Command Line”

“The Command-Line Interface for the Fixed-Point Tool”

Introduced in R2019a

showTolerances

Package: DataTypeWorkflow

Show tolerances specified for a system

Syntax

```
showTolerances(proposalSettings)
```

Description

`showTolerances(proposalSettings)` displays the absolute, relative, and time tolerances specified for a system specified by the `proposalSettings` object. If the `proposalSettings` object has no tolerances specified, the `showTolerances` object function does not display anything.

Examples

Specify Signal Tolerances

This example shows how to apply and remove tolerances from signals in a system. In this example, you add tolerances to a `DataTypeWorkflow.proposalSettings` object, and then remove all tolerances from this object.

```
model = 'fxpdemo_feedback';
open_system(model);
```

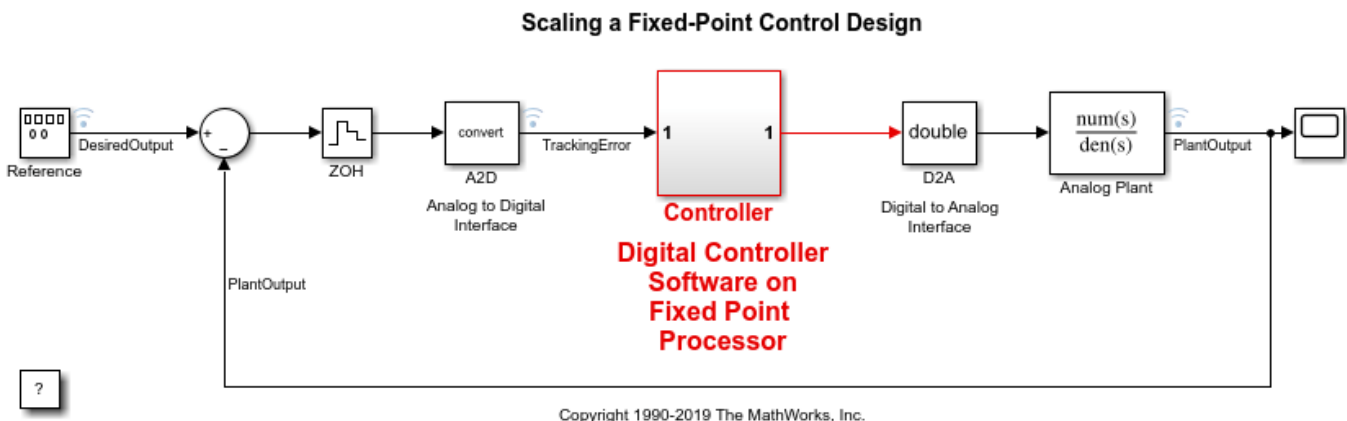

Create a `DataTypeWorkflow.ProposalSettings` object.

```
propSettings = DataTypeWorkflow.ProposalSettings;
```

Add an absolute tolerance of 0.05 to the output of the Down Cast block in the Controller subsystem.

```
addTolerance(propSettings, 'fxpdemo_feedback/Controller/Down Cast',1,'AbsTol',5e-2);
```

Add a relative tolerance of 1% to the same signal.

```
addTolerance(propSettings, 'fxpdemo_feedback/Controller/Down Cast',1,'RelTol',1e-2);
```

Use `showTolerances` to see all tolerances associated with the proposal settings object.

```
showTolerances(propSettings)
```

Path	Port_Index	Tolerance_Type	Tolerance_Value
{'fxpdemo_feedback/Controller/Down Cast'}	1	{'AbsTol'}	0.05
{'fxpdemo_feedback/Controller/Down Cast'}	1	{'RelTol'}	0.01

Clear the tolerances stored in the `ProposalSettings` object.

```
clearTolerances(propSettings)
```

Using `showTolerances`, verify that there are no longer any tolerances stored in the `ProposalSettings` object.

```
showTolerances(propSettings)
```

Input Arguments

proposalSettings — Object that contains proposal settings

`DataTypeWorkflow.ProposalSettings` object

Object that contains proposal settings, specified as a `DataTypeWorkflow.ProposalSettings` object. This object specifies tolerances and settings to use during the data type proposal process.

See Also

`DataTypeWorkflow.ProposalSettings` | `addTolerance` | `clearTolerances`

Topics

“Convert a Model to Fixed Point Using the Command Line”

“The Command-Line Interface for the Fixed-Point Tool”

Introduced in R2019a

convertToSingle

Package: DataTypeWorkflow

Convert a double-precision system to single precision

Syntax

```
ConversionReport = DataTypeWorkflow.Single.convertToSingle(systemToConvert)
```

Description

`ConversionReport = DataTypeWorkflow.Single.convertToSingle(systemToConvert)` converts the system specified by `systemToConvert` to single precision and returns a report. Data types that are specified as Boolean, fixed point, or one of the built-in integers are not affected by conversion.

Examples

Convert a System to Single Precision

- 1 Open the system to convert to single precision.

```
addpath(fullfile(docroot, 'toolbox', 'fixpoint', 'examples'))
ex_fuel_rate_calculation
```

- 2 Use the `DataTypeWorkflow.Single.convertToSingle` method to convert the system from double precision to single precision.

```
report = DataTypeWorkflow.Single.convertToSingle('ex_fuel_rate_calculation')
```

The specified system now uses single-precision data types instead of double-precision data types. Data types in the model that were specified as Boolean, fixed-point, or one of the built-in integers remain the same after conversion.

Input Arguments

systemToConvert — System to convert to single precision

character vector

The system to convert from double-precision to single-precision, specified as a character vector. The system must be open before using this method.

Data Types: char

Output Arguments

ConversionReport — Report containing results from the conversion

report

Report containing results from the conversion.

Alternatives

You can also use the Single Precision Converter app to convert a system from double precision to single precision. To open the Single Precision Converter app, in the Simulink **Apps** tab, select **Single Precision Converter**. For more information, see “Getting Started with Single Precision Converter”.

See Also

Single Precision Converter

Topics

“Convert a System to Single Precision”

“Getting Started with Single Precision Converter”

Introduced in R2016b

explore

Package: `DataTypeWorkflow`

Explore comparison of baseline and fixed-point implementations

Syntax

```
explore(verificationResult)
```

Description

`explore(verificationResult)` opens the Simulation Data Inspector with the logged data for the `DataTypeWorkflow.VerificationResult` object specified by `verificationResult`.

Input Arguments

verificationResult — Object comparing behavior of a baseline run and a verification run

`DataTypeWorkflow.VerificationResult` object

Object comparing the behavior of a baseline run and a verification run, specified as a `DataTypeWorkflow.VerificationResult` object.

See Also

`DataTypeWorkflow.Converter` | `DataTypeWorkflow.ProposalSettings` | `DataTypeWorkflow.VerificationResult`

Topics

“Convert a Model to Fixed Point Using the Command Line”

Introduced in R2019a

getNumDataPointsInfo

Package: fixed

Get information about number of data points in generated data

Syntax

```
datainfo = getNumDataPointsInfo(datagenerator)
```

Description

`datainfo = getNumDataPointsInfo(datagenerator)` returns information about the data points generated by the `fixed.DataGenerator` object, `datagenerator`.

Examples

Get information about number of data points in generated data

The `getNumDataPointsInfo` function returns information related to the number of data points in the data generated from a `fixed.DataGenerator` object.

```
dataspec = fixed.DataSpecification('fixdt(1,16,13)',...
    'Intervals', {-1,1})
dataspec =
    fixed.DataSpecification with properties:
        DataTypeStr: 'sfix16_En13'
        Intervals: [-1,1]
        MandatoryValues: <empty>
        Complexity: 'real'
        Dimensions: 1

datagen = fixed.DataGenerator('DataSpecifications', dataspec,...
    'NumDataPointsLimit', 20);
getNumDataPointsInfo(datagen)

ans =
    struct with fields:
        Current: 20
        Next: 21
        Min: 5
        Max: 75
```

The output indicates that there are currently 20 data combinations in the generated data. The maximum number of combinations that the `DataGenerator` object would produce is 75.

Get information about number of data points for multidimensional data

When the dimension of the generated data is greater than one, it can be useful to find the next possible size of generated data.

Create a `DataGenerator` object where the associated `DataSpecification` object specifies 2-dimensional data.

```
dataspec = fixed.DataSpecification('single', 'Dimensions', 2);
datagen = fixed.DataGenerator('DataSpecifications', dataspec)
```

```
datagen =
```

```
fixed.DataGenerator with properties:
```

```
  DataSpecifications: {[1×1 fixed.DataSpecification]}
  NumDataPointsLimit: 100000
```

The `DataGenerator` object uses the default limit of 100000 data points in the generated data.

Get information about the number of data points generated.

```
getNumDataPointsInfo(datagen)
```

```
ans =
```

```
struct with fields:
```

```
  Current: 99856
  Next: 100489
  Min: 81
  Max: 130321
```

The current size of the generated data is 99856 points. By setting the `NumDataPointsLimit` property of the `DataGenerator` object to the value specified in `Max`, you can get the maximum possible number of data combinations.

Set the `NumDataPointsLimit` property of the `DataGenerator` object to the maximum possible number of data points.

```
datagen.NumDataPointsLimit = 130321;
getNumDataPointsInfo(datagen)
```

```
ans =
```

```
struct with fields:
```

```
  Current: 130321
  Next: 130321
  Min: 81
  Max: 130321
```

Input Arguments

datagenerator — Object from which you want to get information

`fixed.DataGenerator` object

Object from which you want to get information, specified as a `fixed.DataGenerator` object.

Output Arguments

datainfo — Information about the number of data points

struct

Information about the number of data points in the data generated from a `fixed.DataGenerator` object, returned as a struct with the following fields.

Field	Description
Current	The number of data combinations in the generated data.
Next	Next possible size of data combinations.
Min	Minimum number of combinations of data required to be in the generated data. This number is equal to the number of boundary values and mandatory values in the <code>DataSpecification</code> objects associated with the <code>DataGenerator</code> object.
Max	Maximum number of combinations that could be in the generated data.

See Also

`fixed.DataGenerator` | `getUniqueValues` | `outputAllData`

Introduced in R2019b

getUniqueValues

Package: fixed

Get unique values from `fixed.DataGenerator` object

Syntax

```
data = getUniqueValues(datagenerator)
```

Description

`data = getUniqueValues(datagenerator)` returns all unique values in the data generated by the `fixed.DataGenerator` object, `datagenerator`.

Examples

Get unique values in data from DataGenerator object

In data generated from a `fixed.DataGenerator` object, there can be repeated values. Use the `getUniqueValues` function to get all of the unique values in the data set.

```
dataspec = fixed.DataSpecification('fixdt(1,16,13)',...
    'Intervals', {-1,1})
```

```
dataspec =
```

```
fixed.DataSpecification with properties:
```

```
    DataTypeStr: 'sfix16_En13'
    Intervals: [-1,1]
    MandatoryValues: <empty>
    Complexity: 'real'
    Dimensions: 1
```

```
datagen = fixed.DataGenerator('DataSpecifications', dataspec,...
    'NumDataPointsLimit', 20);
getUniqueValues(datagen)
```

```
ans =
```

```
-1.0000
-0.9999
-0.4999
-0.2500
-0.0624
-0.0313
-0.0039
-0.0021
-0.0005
-0.0002
    0
```

```
0.0010  
0.0018  
0.0078  
0.0155  
0.0157  
0.1249  
0.1251  
0.9999  
1.0000
```

```
    DataTypeMode: Fixed-point: binary point scaling  
      Signedness: Signed  
      WordLength: 16  
      FractionLength: 13
```

Input Arguments

datagenerator — Input fixed.DataGenerator object

fixed.DataGenerator object

Input fixed.DataGenerator object to get unique values from.

Output Arguments

data — Unique set of values in data

scalar | vector | matrix

Unique set of data generated by the input fixed.DataGenerator object, returned as a scalar, vector, or matrix.

See Also

fixed.DataGenerator | getNumDataPointsInfo | outputAllData

Introduced in R2019b

outputAllData

Package: fixed

Get data from `fixed.DataGenerator` object

Syntax

```
data = outputAllData(datagenerator)
data = outputAllData(datagenerator, format)
```

Description

`data = outputAllData(datagenerator)` returns the data generated by the `fixed.DataGenerator` object, `datagenerator`.

`data = outputAllData(datagenerator, format)` returns the data generated by the `fixed.DataGenerator` object, `datagenerator`, in the format specified by `format`.

Examples

Get data as an array

Get the data from a `fixed.DataGenerator` object, returned as an array of values.

```
dataspec = fixed.DataSpecification('int8', 'Intervals', {-1,1});
datagen = fixed.DataGenerator('DataSpecifications', dataspec, ...
    'NumDataPointsLimit', 20)
```

```
datagen =
```

```
    fixed.DataGenerator with properties:
```

```
    DataSpecifications: {[1x1 fixed.DataSpecification]}
    NumDataPointsLimit: 20
```

Use the `outputAllData` function to access the data in the `DataGenerator` object.

```
data = outputAllData(datagen)
```

```
data =
```

```
    1x3 int8 row vector
    -1     0     1
```

The function returns the data in an array with the type specified by the `fixed.DataSpecification` object.

Get data as a timeseries object

Get the data from a `fixed.DataGenerator` object, returned as a `timeseries` object.

```
dataspec = fixed.DataSpecification('int8', 'Intervals', {-1,1});
datagen = fixed.DataGenerator('DataSpecifications', dataspec,...
    'NumDataPointsLimit', 2000)
```

```
datagen =
```

```
fixed.DataGenerator with properties:
```

```
DataSpecifications: {[1x1 fixed.DataSpecification]}
NumDataPointsLimit: 20000
```

Specify the format of the output type to get a `timeseries` object.

```
data = outputAllData(datagen, 'timeseries')
```

```
timeseries
```

```
Common Properties:
```

```
Name: 'unnamed'
Time: [3x1 double]
TimeInfo: [1x1 tsdata.timemetadata]
Data: [3x1 int8]
DataInfo: [1x1 tsdata.datametadata]
```

Input Arguments

datagenerator — Object from which you want to get data

`fixed.DataGenerator` object

Object from which you want to get data, specified as a `fixed.DataGenerator` object.

format — Format in which you want data returned

'array' (default) | 'timeseries' | 'dataset'

Format in which you want data returned, specified as either 'array', 'timeseries', or 'dataset'.

Specifying 'dataset' returns a `Simulink.SimulationData.Dataset` object. Specifying 'timeseries' returns a `timeseries` object.

```
Example: data = outputAllData(datagen, 'timeseries');
```

Data Types: char

Output Arguments

data — Data from the DataGenerator object

scalar | vector | matrix | `timeseries` object

Data from the `DataGenerator` object, returned as either a scalar, vector, matrix, or `timeseries` object.

See Also

`fixed.DataGenerator` | `getNumDataPointsInfo` | `getUniqueValues`

Introduced in R2019b

applyOnRootInport

Package: fixed

(To be removed) Apply properties to Inport block

Note `applyOnRootInport` will be removed in a future release.

Syntax

```
applyOnRootInport(dataspec, model, inportnumber)
```

Description

`applyOnRootInport(dataspec, model, inportnumber)` applies the properties specified in `fixed.DataSpecification` object, `dataspec` to the specified Inport block in `model`.

Input Arguments

dataspec — Properties to apply to Inport block

`fixed.DataSpecification` object

Properties to apply to Inport block, specified as a `fixed.DataSpecification` object.

model — Model containing Inport block

character vector

Name of the model containing the Inport block to apply settings to, specified as a character vector.

Data Types: `char`

inportnumber — Number of Inport block

scalar integer

Port number of root-level Inport block on which you want to apply properties from the `fixed.DataSpecification` object. The following properties of the `DataSpecification` object are applied to the block:

- Data type
- Complexity
- Dimensions

Data Types: `double`

Compatibility Considerations

applyOnRootInport will be removed

Warns starting in R2020a

`applyOnRootInport` will be removed in a future release.

See Also

contains | fixed.DataSpecification

Introduced in R2019b

contains

Package: fixed

Determine whether value domain of a `DataSpecification` object contains a specified value

Syntax

```
bool = contains(dataspec, value)
```

Description

`bool = contains(dataspec, value)` returns a boolean value indicating whether the value domain of the `fixed.DataSpecification` object, `dataspec`, contains the value, `value`.

Examples

Determine whether a fixed.DataSpecification object contains a value

Use the `contains` function to determine whether a `fixed.DataSpecification` object contains a specified value.

```
dataspec = fixed.DataSpecification('int8', 'Intervals', {-1,1})
```

```
dataspec =
```

```
fixed.DataSpecification with properties:
```

```
    DataTypeStr: 'int8'  
    Intervals: [-1,1]  
    MandatoryValues: <empty>  
    Complexity: 'real'  
    Dimensions: 1
```

Determine whether `dataspec` contains the value 0.

```
bool = contains(dataspec, 0)
```

```
bool =
```

```
logical
```

```
1
```

Input Arguments

dataspec — `fixed.DataSpecification` object

`fixed.DataSpecification` object

Input `fixed.DataSpecification` object.

value – Value

scalar | vector

Value or values to check for in the `fixed.DataSpecification` object, specified as a scalar, or vector.

Data Types: `single` | `double` | `int8` | `int16` | `int32` | `int64` | `uint8` | `uint16` | `uint32` | `uint64` | `fi`

Output Arguments**bool – Whether the `fixed.DataSpecification` object contains the value**`true` | `false` | vector of logical values

Whether the `fixed.DataSpecification` object contains the value, returned as a boolean value.

If the `value` argument is a vector, the output is a boolean vector of the same length.

See Also`applyOnRootInport` | `fixed.DataSpecification`**Introduced in R2019b**

contains

Package: `fixed`

Determine if one `fixed.Interval` object contains another

Syntax

```
bool = contains(A, B)
```

Description

`bool = contains(A, B)` returns a boolean indicating whether `fixed.Interval` object A contains the `fixed.Interval` object B.

Examples

Determine if a `fixed.Interval` object contains another

Create two `fixed.Interval` objects. Use the `contains` function to determine if the intervals in `interval2` are contained within the corresponding intervals in `interval1`.

```
interval1 = fixed.Interval({0,1}, {2,3}, {3,4});  
interval2 = fixed.Interval({0,0.5}, {2.5, 3}, {4,5});  
bool = contains(interval1, interval2)
```

`bool = 1x3 logical array`

```
1 1 0
```

When the second input is a scalar `Interval` object, `contains` determines whether each interval of the first input contains the interval of the second input.

```
interval2 = fixed.Interval(0,1);  
bool = contains(interval1, interval2)
```

`bool = 1x3 logical array`

```
1 0 0
```

Input Arguments

A, B — Input `fixed.Interval` objects

`fixed.Interval` object | array of `fixed.Interval` objects

Input `fixed.Interval` objects, specified as `fixed.Interval` objects, or arrays of `fixed.Interval` objects.

If `A` is an array of `Interval` objects, `B` must be a scalar `Interval` object or an `Interval` object with the same dimensions as `A`.

Output Arguments

bool — Whether B is contained in A

`true` | `false` | logical array

Whether `fixed.Interval` object `B` is contained in `fixed.Interval` object `A`, returned as a logical value.

When `A` is an array of `Interval` objects, the output is an array of logical values of the same size as `A`.

See Also

`fixed.Interval` | `intersect` | `overlaps` | `setdiff` | `union` | `unique`

Introduced in R2019b

intersect

Package: fixed

Intersection of `fixed.Interval` objects

Syntax

```
C = intersect(A, B)
```

Description

`C = intersect(A, B)` returns the intersection of `fixed.Interval` objects A and B.

Examples

Get intersection of two `fixed.Interval` objects

Create two `fixed.Interval` objects.

```
interval1 = fixed.Interval(-10,10)
```

```
interval1 =  
  [-10,10]
```

1x1 `fixed.Interval` with properties:

```
    LeftEnd: -10  
    RightEnd: 10  
    IsLeftClosed: true  
    IsRightClosed: true
```

```
interval2 = fixed.Interval(0,20)
```

```
interval2 =  
  [0,20]
```

1x1 `fixed.Interval` with properties:

```
    LeftEnd: 0  
    RightEnd: 20  
    IsLeftClosed: true  
    IsRightClosed: true
```

Find the intersection of the two `Interval` objects.

```
intervalIntersection12 = intersect(interval1,interval2)
```

```
intervalIntersection12 =  
  [0,10]
```

1x1 `fixed.Interval` with properties:

```

    LeftEnd: 0
    RightEnd: 10
    IsLeftClosed: true
    IsRightClosed: true

```

The output is an `Interval` object whose range is the intersection of the ranges of the two input `Interval` objects.

When the ranges of the two input `Interval` objects do not overlap, the output is an empty `Interval` object.

```
interval3 = fixed.Interval(100,200)
```

```
interval3 =
  [100,200]
```

```
1x1 fixed.Interval with properties:
```

```

    LeftEnd: 100
    RightEnd: 200
    IsLeftClosed: true
    IsRightClosed: true

```

```
intervalIntersection3 = intersect(interval1,interval3)
```

```
intervalIntersection3 =
```

```
1x0 fixed.Interval with properties:
```

```

    LeftEnd
    RightEnd
    IsLeftClosed
    IsRightClosed

```

Input Arguments

A, B — Input `fixed.Interval` objects

`fixed.Interval` object | array of `fixed.Interval` objects

Input `fixed.Interval` objects, specified as `fixed.Interval` objects, or arrays of `fixed.Interval` objects.

Output Arguments

C — Intersection of `fixed.Interval` objects

`fixed.Interval` object | array of `fixed.Interval` objects

Intersection of input `fixed.Interval` objects, returned as a `fixed.Interval` object or an array of `fixed.Interval` objects.

The output `Interval` object contains all values in both inputs, A and B.

See Also

`contains` | `fixed.Interval` | `overlaps` | `setdiff` | `union` | `unique`

Introduced in R2019b

isDegenerate

Package: fixed

Determine whether the left and right ends of a `fixed.Interval` object are degenerate

Syntax

```
bool = isDegenerate(A)
```

Description

`bool = isDegenerate(A)` returns a boolean indicating whether the left and right ends of the `fixed.Interval` object `A` are the same, or equivalently, whether the interval contains only one point.

Examples

Determine if a `fixed.Interval` object has degenerate end points

Create a `fixed.Interval` object. Use the `isDegenerate` function to determine whether the left and right ends of the `Interval` object are the same.

```
interval = fixed.Interval({-pi,pi},{1,1});  
bool = isDegenerate(interval)
```

```
bool = 1x2 logical array
```

```
    0    1
```

The output is a logical 0 when the left and right ends of the interval are different, and 1 when they are the same.

Input Arguments

A — `fixed.Interval` object

`fixed.Interval` object | array of `fixed.Interval` objects

Input `fixed.Interval` object, specified as a `fixed.Interval` object, or an array of `fixed.Interval` objects.

Output Arguments

bool — Indicates whether left and right ends of `A` are degenerate

true | false | logical array

Indicates whether the `fixed.Interval` object `A` has degenerate end points. Returns 1 (true) when the left and right ends of `A` are the same, or equivalently, when the interval contains only one point, and 0 (false) otherwise.

When `A` is an array of `Interval` objects, the output is an array of logical values of the same size as `A`.

See Also

`fixed.Interval` | `isLeftBounded` | `isRightBounded` | `isnan`

Introduced in R2019b

isLeftBounded

Package: fixed

Determine whether a `fixed.Interval` object is left-bounded

Syntax

```
bool = isLeftBounded(A)
```

Description

`bool = isLeftBounded(A)` returns a boolean indicating whether the `fixed.Interval` object `A` is left-bounded.

Examples

Determine if a `fixed.Interval` object is left bounded

Create a `fixed.Interval` object. Use the `isLeftBounded` function to determine whether the interval is bounded on the left.

```
interval = fixed.Interval({-pi,pi},{-inf,1});
bool = isLeftBounded(interval)
```

bool = 1x2 logical array

```
1  0
```

The output is a logical 1 when the left end of the interval is bounded, and 0 otherwise.

Input Arguments

A — `fixed.Interval` object

`fixed.Interval` object | array of `fixed.Interval` objects

Input `fixed.Interval` object, specified as a `fixed.Interval` object, or an array of `fixed.Interval` objects.

Output Arguments

bool — Indicates whether left end of `A` is bounded

true | false | logical array

Indicates whether the `fixed.Interval` object `A` is left-bounded, returned as a logical value. Returns 0 (false) when `A` contains `-inf`, and 1 (true) otherwise.

When `A` is an array of `Interval` objects, the output is an array of logical values of the same size as `A`.

See Also

`fixed.Interval` | `isDegenerate` | `isRightBounded` | `isnan`

Introduced in R2019b

isnan

Package: fixed

Determine whether a `fixed.Interval` object is NaN

Syntax

```
bool = isnan(A)
```

Description

`bool = isnan(A)` returns a boolean indicating whether a `fixed.Interval` object A is NaN.

Examples

Determine if a `fixed.Interval` object is NaN

Create a `fixed.Interval` object. Use the `isnan` function to determine whether the `Interval` object is not a number.

```
interval = fixed.Interval({-pi,pi},{nan,1},{nan,nan});  
bool = isnan(interval)
```

```
bool = 1x3 logical array
```

```
  0  1  1
```

The output is a logical 1 when the interval contains one or more NaN elements, and 0 otherwise.

Input Arguments

A — `fixed.Interval` object

`fixed.Interval` object | array of `fixed.Interval` objects

Input `fixed.Interval` object, specified as a `fixed.Interval` object, or an array of `fixed.Interval` objects.

Output Arguments

bool — Indicates whether elements of A are NaN

true | false | logical array

Indicates whether the `fixed.Interval` object A is NaN, returned as a logical value.

When A is an array of `Interval` objects, the output is an array of logical values of the same size as A.

See Also

`fixed.Interval` | `isDegenerate` | `isLeftBounded` | `isRightBounded`

Introduced in R2019b

isRightBounded

Package: fixed

Determine whether the a `fixed.Interval` object is right-bounded

Syntax

```
bool = isRightBounded(A)
```

Description

`bool = isRightBounded(A)` returns a boolean indicating whether the `fixed.Interval` object A is right-bounded.

Examples

Determine if a `fixed.Interval` object is right bounded

Create a `fixed.Interval` object. Use the `isRightBounded` function to determine whether the interval is bounded on the right.

```
interval = fixed.Interval({-pi,pi},{-1,inf});
bool = isRightBounded(interval)
```

bool = 1x2 logical array

```
1  0
```

The output is logical 1 when the right end of the interval is bounded, and 0 otherwise.

Input Arguments

A — `fixed.Interval` object

`fixed.Interval` object | array of `fixed.Interval` objects

Input `fixed.Interval` object, specified as a `fixed.Interval` object, or an array of `fixed.Interval` objects.

Output Arguments

bool — Indicates whether right end of A is bounded

Boolean scalar | Boolean array

Indicates whether the `fixed.Interval` object A is right-bounded, returned as a logical value. Returns 0 (false) when A contains `inf`, and 1 (true) otherwise.

When A is an array of `Interval` objects, the output is an array of logical values of the same size as A.

See Also

`fixed.Interval` | `isDegenerate` | `isLeftBounded` | `isnan`

Introduced in R2019b

overlaps

Package: fixed

Determine if two `fixed.Interval` objects overlap

Syntax

```
bool = overlaps(A, B)
```

Description

`bool = overlaps(A, B)` returns a boolean indicating whether two `fixed.Interval` objects overlap.

Examples

Determine if two `fixed.Interval` objects overlap

Create two `fixed.Interval` objects and determine if their ranges overlap.

```
interval1 = fixed.Interval(-1, 1);  
interval2 = fixed.Interval(0, 1);  
overlaps(interval1, interval2)
```

```
ans =
```

```
logical
```

```
1
```

When the ranges of the `Interval` objects overlap, the `overlaps` function returns a value of 1, or true.

Input Arguments

A, B — Input `fixed.Interval` objects

`fixed.Interval` object | array of `fixed.Interval` objects

Input `fixed.Interval` objects, specified as `fixed.Interval` objects, or arrays of `fixed.Interval` objects.

Output Arguments

bool — Whether the intervals overlap

true | false | vector of logical values

Whether the input `fixed.Interval` objects overlap, returned as a logical value or a vector of logical values.

See Also

`contains` | `fixed.Interval` | `intersect` | `setdiff` | `union` | `unique`

Introduced in R2019b

quantize

Package: fixed

Quantize interval to range of numeric data type

Syntax

```
quantizedinterval = quantize(interval, numerictype)
quantizedinterval = quantize(interval, numerictype, Name, Value)
```

Description

`quantizedinterval = quantize(interval, numerictype)` returns the quantized range of `fixed.Interval` object, `interval`, quantized to the numeric type specified by `numerictype`.

`quantizedinterval = quantize(interval, numerictype, Name, Value)` returns the quantized range of `fixed.Interval` object, `interval`, with additional properties specified as name-value pairs.

Examples

Quantize a numeric interval to uint8

Create a `fixed.Interval` object and find the range of the `Interval` object quantized to an unsigned 8-bit integer.

```
interval = fixed.Interval(-200,200);
quantizedInterval = quantize(interval, 'fixdt(0,8,0)')
```

```
quantizedInterval =
    1×2 uint8 row vector
    0    200
```

Because `fixdt(0,8,0)` is equivalent to `uint8`, the `quantize` function returns the quantized range as a `uint8` row vector with the endpoints within the representable range of the numeric type.

To return the quantized row vector as a fixed-point data type, set the `'PreferBuiltIn'` property to `false`.

```
quantizedInterval = quantize(interval, 'fixdt(0,8,0)',...
    'PreferBuiltIn', false)
```

```
quantizedInterval =
    0    200
    DataTypeMode: Fixed-point: binary point scaling
    Signedness: Unsigned
```

```
WordLength: 8
FractionLength: 0
```

Input Arguments

interval — Input fixed.Interval objects to quantize

`fixed.Interval` object | array of `fixed.Interval` objects

Input `fixed.Interval` object, specified as a `fixed.Interval` object, or an array of `fixed.Interval` objects.

numerictype — Numeric data type

`Simulink.Numerictype` object | `embedded.numerictype` object | character vector

Numeric data type to quantize the `Interval`, specified as a `Simulink.Numerictype` object, an `embedded.numerictype` object, or a character vector representing a numeric data type, for example, `'single'`.

Example: `quantizedinterval = quantize(interval, 'fixdt(1,16,8)');`

Name-Value Pair Arguments

Specify optional comma-separated pairs of `Name`, `Value` arguments. `Name` is the argument name and `Value` is the corresponding value. `Name` must appear inside quotes. You can specify several name and value pair arguments in any order as `Name1, Value1, ..., NameN, ValueN`.

Example: `interval = quantize(interval, 'fixdt(1,16,0)', 'PreferBuiltIn', false, 'PreferStrict', true);`

PreferBuiltIn — Quantize to built-in data type when possible

`true` (default) | `false`

When this property is true, if the specified `numerictype` has an equivalent built-in integer type the software returns the built-in type. For example, when this property is true, a specified `numerictype` of `'fixdt(1,8,0)'` would return an `int8`.

Data Types: `logical`

PreferStrict — Quantize end points to numeric type

`false` (default) | `true`

When this property is true, all ends are quantized to the closest representable values within original intervals regardless of whether the intervals are closed or open.

Data Types: `logical`

Output Arguments

quantizedinterval — Quantized interval range

N-by-2 matrix

N-by-2 matrix with rows consisting of endpoints of input `Interval` objects quantized to the numeric data type specified by `numerictype`.

When the `'PreferStrict'` property is set to `false`, the end points after quantization may lie outside the original interval.

See Also

`contains` | `fixed.Interval` | `intersect` | `overlaps` | `union` | `unique`

Introduced in R2019b

setdiff

Package: `fixed`

Set difference of `fixed.Interval` objects

Syntax

```
C = setdiff(A, B)
```

Description

`C = setdiff(A, B)` returns a `fixed.Interval` object containing the values in `fixed.Interval` object A, but not in B.

Examples

Get set difference of two `fixed.Interval` objects

Create two `fixed.Interval` objects. Use the `setdiff` function to find the values that are in `Interval` object `interval1` but not in `interval2`. In this example, `interval1` contains all values between 0 and 1, but `interval2` only contains values from 0 to 0.5, so the output `Interval` object has an interval from 0.5 to 1.

```
interval1 = fixed.Interval(0,1);
interval2 = fixed.Interval(0,0.5);
intervaldiff = setdiff(interval1, interval2)
```

```
intervaldiff =
    (0.5000,1]
```

```
1x1 fixed.Interval with properties:
```

```
    LeftEnd: 0.5000
    RightEnd: 1
    IsLeftClosed: false
    IsRightClosed: true
```

Create an interval object that excludes zero

You can use the `setdiff` function to create an interval object based on another interval, while excluding zero.

Create an `Interval` object that contains zero.

```
myInterval = fixed.Interval(-1,1);
```

To create an interval based on the `Interval` object, `myInterval`, use the `setdiff` function. Include the constructor for a degenerate `Interval` object containing only zero as the second argument.

```
myInterval_nozero = setdiff(myInterval, {0});
```

```
myInterval_nozero =
```

```
    [-1,0)    (0,1]
```

```
    1x2 fixed.Interval with properties:
```

```
        LeftEnd
        RightEnd
        IsLeftClosed
        IsRightClosed
```

The output `Interval` object, `myInterval_nozero`, contains two intervals, each with an open end point at zero. Therefore, the interval contains all values between -1 and 1, except 0.

Input Arguments

A, B — Input `fixed.Interval` objects

`fixed.Interval` object | array of `fixed.Interval` objects

Input `fixed.Interval` objects, specified as `fixed.Interval` objects, or arrays of `fixed.Interval` objects.

Output Arguments

C — Set difference of `fixed.Interval` objects

`fixed.Interval` object | array of `fixed.Interval` objects

Set difference of input `fixed.Interval` objects, returned as a `fixed.Interval` object or an array of `fixed.Interval` objects.

The output `Interval` object contains all values in first input, A, but not in B.

See Also

`contains` | `fixed.Interval` | `intersect` | `overlaps` | `union`

Introduced in R2019b

union

Package: fixed

Union of fixed.Interval objects

Syntax

```
C = union(A, B)
```

Description

`C = union(A, B)` returns the union of fixed.Interval objects A and B.

Examples

Get the union of two fixed.Interval objects

Create two fixed.Interval objects.

```
interval1 = fixed.Interval(-10, 10)
```

```
interval1 =  
  [-10,10]
```

1x1 fixed.Interval with properties:

```
    LeftEnd: -10  
    RightEnd: 10  
    IsLeftClosed: true  
    IsRightClosed: true
```

```
interval2 = fixed.Interval(0,20)
```

```
interval2 =  
  [0,20]
```

1x1 fixed.Interval with properties:

```
    LeftEnd: 0  
    RightEnd: 20  
    IsLeftClosed: true  
    IsRightClosed: true
```

Find the union of the two Interval objects.

```
intervalUnion = union(interval1, interval2)
```

```
intervalUnion =  
  [-10,20]
```

1x1 fixed.Interval with properties:

```

    LeftEnd: -10
    RightEnd: 20
    IsLeftClosed: true
    IsRightClosed: true

```

The output is an `Interval` object whose range is the union of the ranges of the two input objects.

When the ranges of the two input `Interval` objects do not overlap, the output is an array of `Interval` objects covering the union of the ranges of the inputs.

```
interval3 = fixed.Interval(100, 200)
```

```
interval3 =
  [100,200]
```

```
1x1 fixed.Interval with properties:
```

```

    LeftEnd: 100
    RightEnd: 200
    IsLeftClosed: true
    IsRightClosed: true

```

```
intervalUnion = union(interval1, interval3)
```

```
intervalUnion=1x2 object
  [-10,10]  [100,200]
```

```
1x2 fixed.Interval with properties:
```

```

    LeftEnd
    RightEnd
    IsLeftClosed
    IsRightClosed

```

Input Arguments

A, B — Input `fixed.Interval` objects

`fixed.Interval` object | array of `fixed.Interval` objects

Input `fixed.Interval` objects, specified as `fixed.Interval` objects, or arrays of `fixed.Interval` objects.

Output Arguments

C — Union of `fixed.Interval` objects

`fixed.Interval` object | array of `fixed.Interval` objects

Union of input `fixed.Interval` objects, returned as a `fixed.Interval` object or an array of `fixed.Interval` objects.

The output `Interval` object contains all values in A or B.

See Also

`contains` | `fixed.Interval` | `intersect` | `overlaps` | `setdiff`

Introduced in R2019b

unique

Package: fixed

Get set of unique values in `fixed.Interval` object

Syntax

```
uniqueInterval = unique(interval)
```

Description

`uniqueInterval = unique(interval)` returns a vector of incrementally sorted and non overlapping intervals that represent an equivalent value set as `fixed.Interval` object, `interval`.

Examples

Create a non-overlapping set of intervals from an array of `Interval` objects

Use the `unique` function to get a non-overlapping set of intervals from an array of `Interval` objects.

```
intervals = fixed.Interval({-5,5},{-10,10},{4,20},{50,100})
```

```
[-5,5]    [-10,10]    [4,20]    [50,100]
```

1x4 `fixed.Interval` with properties:

```
    LeftEnd
    RightEnd
    IsLeftClosed
    IsRightClosed
```

The first three intervals represented in the object overlap with one another. The fourth interval is disjointed from the set.

```
uniqueInterval = unique(intervals)
```

```
uniqueInterval =
```

```
[-10,20]    [50,100]
```

1x2 `fixed.Interval` with properties:

```
    LeftEnd
    RightEnd
    IsLeftClosed
    IsRightClosed
```

The output, `uniqueInterval`, an array of two `Interval` objects, merges the three overlapping intervals into a single `Interval` object.

Input Arguments

interval — **fixed.Interval object**

`fixed.Interval` object | array of `fixed.Interval` objects

Input `fixed.Interval` object, specified as a `fixed.Interval` object, or an array of `fixed.Interval` objects.

Output Arguments

uniqueinterval — **Non-overlapping set of Interval objects**

`fixed.Interval` object | array of `fixed.Interval` objects

Non-overlapping set of `Interval` objects, returned as a `fixed.Interval` object or an array of `fixed.Interval` objects.

When `interval` is a scalar `Interval` object, the output is the same as the input.

See Also

`contains` | `fixed.Interval` | `intersect` | `overlaps` | `setdiff` | `union`

Introduced in R2019b

FunctionApproximation.compressLookupTables

Compress all Lookup Table blocks in a system

Syntax

```
CompressionResult = FunctionApproximation.compressLookupTables(system)
CompressionResult = FunctionApproximation.compressLookupTables(system,
Name,Value)
```

Description

`CompressionResult = FunctionApproximation.compressLookupTables(system)` compresses all n-D Lookup Table blocks in the specified system. The compressed Lookup Table blocks output the same numerical results as the original Lookup Table blocks within the bounds of the breakpoints.

You can achieve additional memory savings by compressing each lookup table in the model individually and specifying tolerances for the compressed lookup table.

`CompressionResult = FunctionApproximation.compressLookupTables(system, Name,Value)` compresses all n-D Lookup Table blocks in the specified system with additional properties specified by name and value pair arguments.

Examples

Compress All Lookup Table Blocks in a System

This example shows how to compress all Lookup Table blocks in a system.

Open the model containing the lookup tables that you want to compress.

```
system = 'sldemo_fuelsys';
open_system(system)
```

Fault-Tolerant Fuel Control System

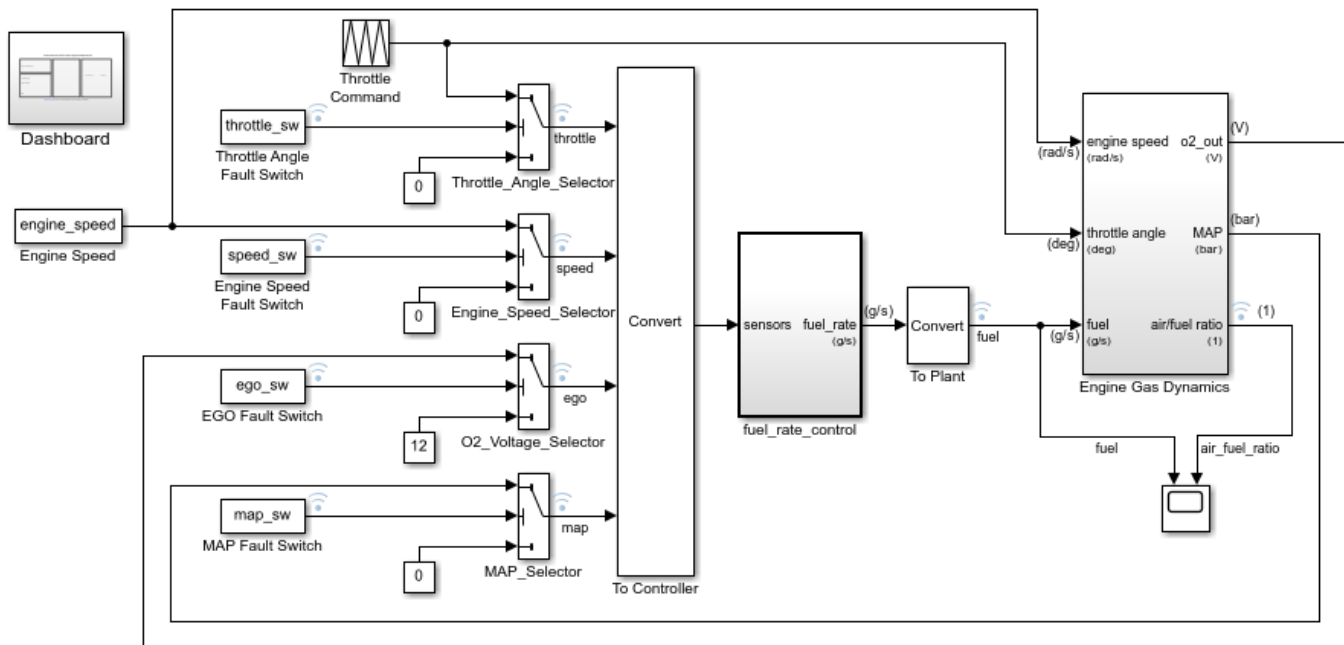

[Open the Dashboard](#) subsystem to simulate any combination of sensor failures.

Copyright 1990-2017 The MathWorks, Inc.

Use the `FunctionApproximation.compressLookupTables` function to compress all of the lookup tables in the model. The output specifies all blocks that are modified and the memory savings for each.

```
compressionResult = FunctionApproximation.compressLookupTables(system)
```

- Found 5 supported lookup tables
- Percent reduction in memory for compressed solution
 - 2.37% for `sldemo_fuelsys/fuel_rate_control/airflow_calc/Pumping Constant`
 - 2.37% for `sldemo_fuelsys/fuel_rate_control/control_logic/Throttle.throttle_estimate/Throt`
 - 3.55% for `sldemo_fuelsys/fuel_rate_control/control_logic/Speed.speed_estimate/Speed Estim`
 - 6.38% for `sldemo_fuelsys/fuel_rate_control/control_logic/Pressure.map_estimate/Pressure E`
 - 9.38% for `sldemo_fuelsys/fuel_rate_control/airflow_calc/Ramp Rate Ki`

```
compressionResult =
```

```
LUTCompressionResult with properties:
```

```

    MemoryUnits: bytes
    MemoryUsageTable: [5x5 table]
    NumLUTsFound: 5
    NumImprovements: 5
    TotalMemoryUsed: 6024
    TotalMemoryUsedNew: 5796
    TotalMemorySavings: 228
    TotalMemorySavingsPercent: 3.7849
    SUD: 'sldemo_fuelsys'
    WordLengths: [8 16 32]
    FindOptions: [1x1 Simulink.internal.FindOptions]
```

Display: 1

Use the `replace` function to replace each Lookup Table block with a block containing the original and compressed version of the lookup table.

```
replace(compressionResult);
```

You can revert the lookup tables back to their original state using the `revert` function.

```
revert(compressionResult);
```

Input Arguments

system — Name of model or subsystem in which to compress all Lookup Table blocks

character vector

Name of model or subsystem in which to compress all n-D Lookup Table blocks, specified as a character vector.

```
Example: compressionResult =
FunctionApproximation.compressLookupTables('sldemo_fuelsys');
```

Data Types: char

Name-Value Pair Arguments

Specify optional comma-separated pairs of `Name`, `Value` arguments. `Name` is the argument name and `Value` is the corresponding value. `Name` must appear inside quotes. You can specify several name and value pair arguments in any order as `Name1, Value1, ..., NameN, ValueN`.

```
Example: CompressionResult =
FunctionApproximation.compressLookupTables('sldemo_fuelsys', 'WordLengths',
[8,16,32])
```

Display — Whether to display details of each iteration of the optimization

true (default) | false

Whether to display details of each iteration of the optimization, specified as a logical. A value of 1 results in information in the command window at each iteration of the approximation process. A value of 0 does not display information until the approximation is complete.

Data Types: logical

WordLengths — Word lengths permitted in the lookup table approximate

integer scalar | integer vector

Specify the word lengths, in bits, that can be used in the lookup table approximate based on your intended hardware. For example, if you intend to target an embedded processor, you can restrict the data types in your lookup table to native types, 8, 16, and 32. The word lengths must be between 1 and 128.

```
Data Types: single | double | int8 | int16 | int32 | int64 | uint8 | uint16 | uint32 | uint64 |
fi
```

FindOptions — Options for finding lookup tables in system

Simulink.FindOptions object

`Simulink.FindOptions` object specifying options for finding lookup tables in the system.

Output Arguments

CompressionResult — **LUTCompressionResult** object created during compression of lookup tables

`LUTCompressionResult` object

Compression result object created during compression of the Lookup Table blocks in the model, returned as a `LUTCompressionResult` object.

See Also

Classes

`LUTCompressionResult`

Functions

`replace` | `revert`

Introduced in R2020a

lutmemoryusage

Class: FunctionApproximation.LUTMemoryUsageCalculator

Package: FunctionApproximation

Calculate memory used by lookup table blocks in a system

Syntax

```
memory = lutmemoryusage(calculator,system)
```

Description

`memory = lutmemoryusage(calculator,system)` calculates the memory used by each lookup table block in the specified model or subsystem.

Input Arguments

calculator — **FunctionApproximation.LUTMemoryUsageCalculator object**
FunctionApproximation.LUTMemoryUsageCalculator

FunctionApproximation.LUTMemoryUsageCalculator object.

system — **Model or subsystem containing lookup table blocks**
character vector

Model or subsystem containing lookup table blocks, specified as a character vector.

Data Types: char

Output Arguments

memory — **Memory used by the lookup tables in the system**
table

Table displaying the memory, in bits, used by each lookup table block in the specified system.

Examples

Calculate the Total Memory Used by Lookup Tables in a Model

Use the `FunctionApproximation.LUTMemoryUsageCalculator` class to calculate the memory used by lookup table blocks in a model.

Create a `FunctionApproximation.LUTMemoryUsageCalculator` object.

```
calculator = FunctionApproximation.LUTMemoryUsageCalculator
```

Use the `lutmemoryusage` method to get the memory used by each lookup table block in the `sldemo_fuelsys` model.

```
load_system('sldemo_fuelsys')
lutmemoryusage(calculator, 'sldemo_fuelsys')
```

```
ans =
```

```
5×2 table
```

```
BlockPath
```

```
1 "sldemo_fuelsys/fuel_rate_control/airflow_calc/Pumping Constant"
2 "sldemo_fuelsys/fuel_rate_control/control_logic/Throttle.throttle_estimate/Throttle Est.
3 "sldemo_fuelsys/fuel_rate_control/control_logic/Speed.speed_estimate/Speed Estimation"
4 "sldemo_fuelsys/fuel_rate_control/control_logic/Pressure.map_estimate/Pressure Estimation"
5 "sldemo_fuelsys/fuel_rate_control/airflow_calc/Ramp Rate Ki"
```

See Also

Apps

Lookup Table Optimizer

Classes

FunctionApproximation.LUTMemoryUsageCalculator |
 FunctionApproximation.LUTSolution | FunctionApproximation.Options |
 FunctionApproximation.Problem

Topics

“Optimize Lookup Tables for Memory-Efficiency Programmatically”
 “Optimize Lookup Tables for Memory-Efficiency”

Introduced in R2018a

approximate

Class: FunctionApproximation.LUTSolution

Package: FunctionApproximation

Generate a Lookup Table block from a FunctionApproximation.LUTSolution

Syntax

```
approximate(solution)
```

Description

`approximate(solution)` generates a Simulink model containing a subsystem made up of the Lookup Table block with data and breakpoints specified by the FunctionApproximation.LUTSolution object, `solution`. The generated Lookup Table block is surrounded with Data Type Conversion blocks.

Input Arguments

solution — Solution to generate lookup table from

FunctionApproximation.LUTSolution object

The solution to generate a lookup table from, specified as a FunctionApproximation.LUTSolution object.

Examples

Generate a Lookup Table Approximating a Function

Create a FunctionApproximation.Problem object defining the function you want to approximate.

```
problem = FunctionApproximation.Problem('tanh')
```

```
problem =
```

```
1x1 FunctionApproximation.Problem with properties:
```

```
FunctionToApproximate: @(x)tanh(x)
  NumberOfInputs: 1
    InputTypes: "numerictype(1,16,12)"
  InputLowerBounds: -8
  InputUpperBounds: 8
    OutputType: "numerictype(1,16,15)"
      Options: [1x1 FunctionApproximation.Options]
```

Use default values for all other options. Approximate the tanh function using the `solve` method.

```
solution = solve(problem)
```

ID	Memory (bits)	Feasible	Table Size	Breakpoints WLS	TableData WL	BreakpointSpec
0	64	0	2	16	16	Ev
1	1248	1	76	16	16	Ev
2	1232	1	75	16	16	Ev
3	944	1	57	16	16	Ev
4	928	1	56	16	16	Ev
5	656	0	39	16	16	Ev
6	640	0	38	16	16	Ev
7	784	1	47	16	16	Ev
8	704	1	42	16	16	Ev
9	672	1	40	16	16	Ev
10	368	0	21	16	16	Ev
11	512	0	30	16	16	Ev
12	592	0	35	16	16	Ev
13	624	0	37	16	16	Ev
14	384	1	12	16	16	Expli
15	384	0	12	16	16	Expli
16	384	1	12	16	16	Expli

Best Solution						
ID	Memory (bits)	Feasible	Table Size	Breakpoints WLS	TableData WL	BreakpointSpec
14	384	1	12	16	16	Expli

solution =

1x1 FunctionApproximation.LUTSolution with properties:

ID: 14
Feasible: "true"

Generate a Simulink™ subsystem containing a Lookup Table block approximating the tanh function.

`approximate(solution)`

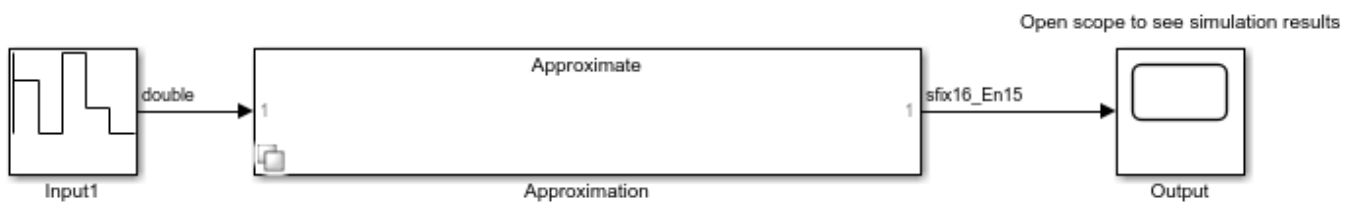

See Also

Apps

Lookup Table Optimizer

Classes

FunctionApproximation.LUTMemoryUsageCalculator |
FunctionApproximation.LUTSolution | FunctionApproximation.Options |
FunctionApproximation.Problem

Functions

approximate | compare | solve

Topics

“Optimize Lookup Tables for Memory-Efficiency Programmatically”

“Optimize Lookup Tables for Memory-Efficiency”

Introduced in R2018a

compare

Class: `FunctionApproximation.LUTSolution`

Package: `FunctionApproximation`

Compare numerical results of `FunctionApproximation.LUTSolution` to original function or lookup table

Syntax

```
data = compare(solution)
```

Description

`data = compare(solution)` plots the difference between the data contained in the `FunctionApproximation.LUTSolution` object, `solution`, and the original lookup table, function, or Math Function block.

Input Arguments

solution — Solution to compare original behavior against

`FunctionApproximation.LUTSolution` object

The solution to compare original behavior against, specified as a `FunctionApproximation.LUTSolution` object.

Output Arguments

data — Struct containing data comparing original and the solution

struct

Struct containing data comparing the original function or lookup table and the approximation contained in the solution.

Examples

Compare Function Approximation to Original Function

Create a `FunctionApproximation.Problem` object defining the function you want to approximate.

```
problem = FunctionApproximation.Problem('tanh')
```

```
problem =
```

```
  1x1 FunctionApproximation.Problem with properties:
```

```
    FunctionToApproximate: @(x)tanh(x)
      NumberOfInputs: 1
        InputTypes: "numeric(1,16,12)"
    InputLowerBounds: -8
    InputUpperBounds: 8
      OutputType: "numeric(1,16,15)"
```



```
Options: [1x1 FunctionApproximation.Options]
```

Use default values for all other options. Approximate the tanh function using the solve method.

```
solution = solve(problem)
```

ID	Memory (bits)	Feasible	Table Size	Breakpoints WLS	TableData WL	BreakpointSpec:
0	64	0	2	16	16	Ev
1	1248	1	76	16	16	Ev
2	1232	1	75	16	16	Ev
3	944	1	57	16	16	Ev
4	928	1	56	16	16	Ev
5	656	0	39	16	16	Ev
6	640	0	38	16	16	Ev
7	784	1	47	16	16	Ev
8	704	1	42	16	16	Ev
9	672	1	40	16	16	Ev
10	368	0	21	16	16	Ev
11	512	0	30	16	16	Ev
12	592	0	35	16	16	Ev
13	624	0	37	16	16	Ev
14	384	1	12	16	16	Expli
15	384	0	12	16	16	Expli
16	384	1	12	16	16	Expli

```
Best Solution
```

ID	Memory (bits)	Feasible	Table Size	Breakpoints WLS	TableData WL	BreakpointSpec:
14	384	1	12	16	16	Expli

```
solution =
```

```
  1x1 FunctionApproximation.LUTSolution with properties:
```

```
    ID: 14
    Feasible: "true"
```

Compare the original function and the function approximation.

```
data = compare(solution)
```

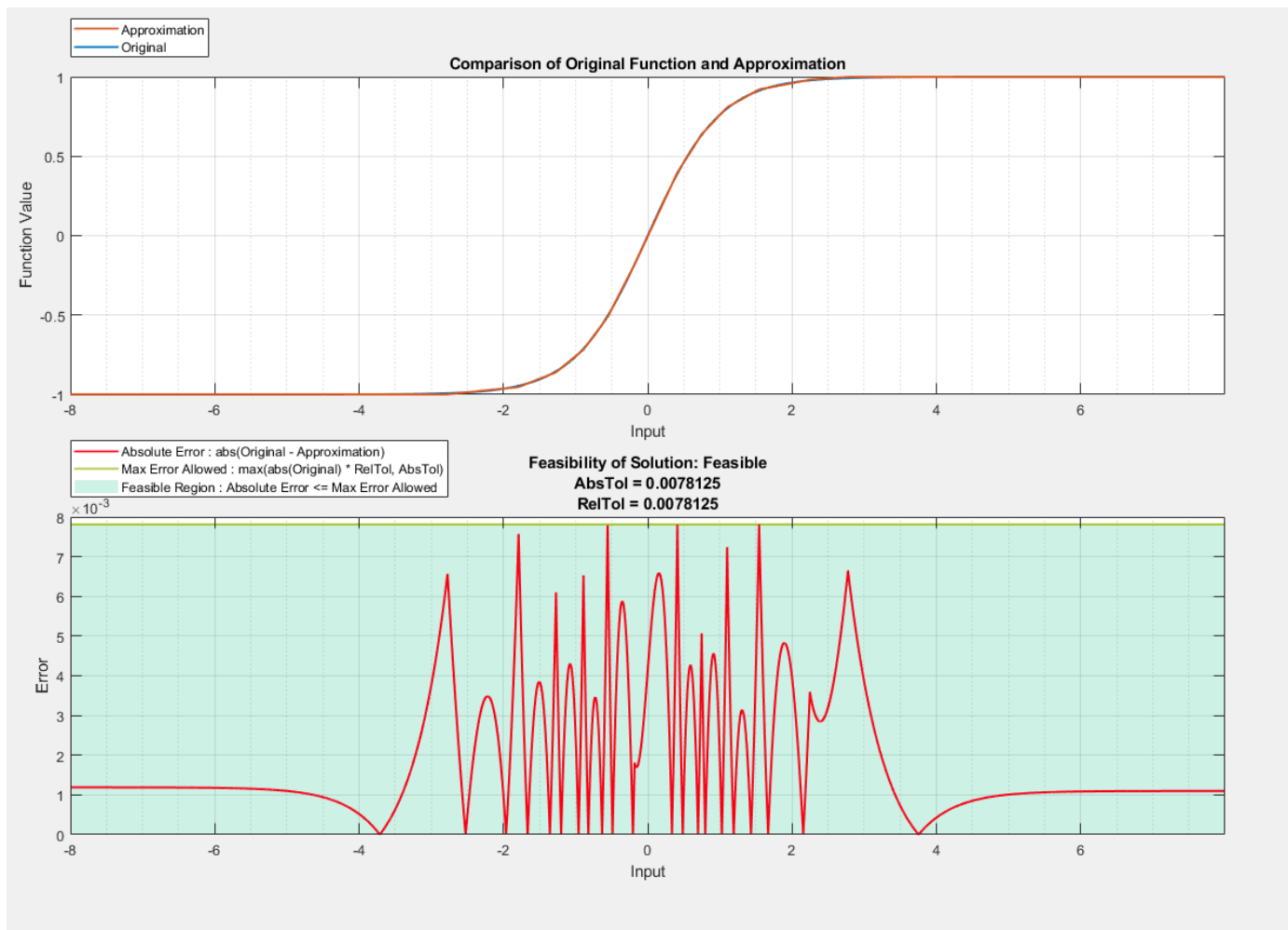

```
data = struct with fields:
  Breakpoints: [65536x1 double]
  Original: [65536x1 double]
  Approximate: [65536x1 double]
```

See Also

Apps

Lookup Table Optimizer

Classes

FunctionApproximation.LUTMemoryUsageCalculator |
FunctionApproximation.LUTSolution | FunctionApproximation.Options |
FunctionApproximation.Problem

Functions

approximate | compare | solve

Topics

“Optimize Lookup Tables for Memory-Efficiency Programmatically”

“Optimize Lookup Tables for Memory-Efficiency”

Introduced in R2018a

displayallsolutions

Class: FunctionApproximation.LUTSolution

Package: FunctionApproximation

Display all solutions found during function approximation

Syntax

```
displayallsolutions(solution)
```

Description

`displayallsolutions(solution)` displays all solutions, including the non-feasible solutions, associated with a `FunctionApproximation.LUTSolution` object.

Input Arguments

solution — Solution object from which to display all associated solutions

`FunctionApproximation.LUTSolution` object

`FunctionApproximation.LUTSolution` object from which to display all associated solutions.

Examples

Display All Solutions Found During Lookup Table Approximation

Create a `FunctionApproximation.Problem` object defining a math function to approximate. Then, use the `solve` method to get a `FunctionApproximation.LUTSolution` object.

Display all solutions found during the approximation process using the `displayallsolutions` method.

```
problem = FunctionApproximation.Problem('sin')
```

```
problem =
```

```
FunctionApproximation.Problem with properties
```

```
FunctionToApproximate: @(x)sin(x)
NumberOfInputs: 1
InputTypes: "numeric(0,16,13)"
InputLowerBounds: 0
InputUpperBounds: 6.2832
OutputType: "numeric(1,16,14)"
Options: [1x1 FunctionApproximation.Options]
```

```
solution = solve(problem)
```

```
solution =
```

```
FunctionApproximation.LUTSolution with properties
```

ID: 8
Feasible: "true"

displayallsolutions(solution)

ID	Memory (bits)	ConstraintMet	Table Size	Breakpoints WLS	TableData WLS
0	64	0	2	16	10
1	464	0	27	16	10
2	864	1	52	16	10
3	64	0	2	16	10
4	560	1	33	16	10
5	304	0	17	16	10
6	432	0	25	16	10
7	496	1	29	16	10
8	464	1	27	16	10
9	448	0	26	16	10
10	704	1	22	16	10

Best Solution

ID	Memory (bits)	ConstraintMet	Table Size	Breakpoints WLS	TableData WLS
8	464	1	27	16	10

See Also

Apps

Lookup Table Optimizer

Classes

FunctionApproximation.LUTMemoryUsageCalculator |
FunctionApproximation.LUTSolution | FunctionApproximation.Options |
FunctionApproximation.Problem

Functions

displayfeasiblesolutions | solutionfromID | totalmemoryusage

Topics

“Optimize Lookup Tables for Memory-Efficiency Programmatically”
“Optimize Lookup Tables for Memory-Efficiency”

Introduced in R2018a

displayfeasiblesolutions

Class: FunctionApproximation.LUTSolution

Package: FunctionApproximation

Display all feasible solutions found during function approximation

Syntax

```
displayfeasiblesolutions(solution)
```

Description

`displayfeasiblesolutions(solution)` displays all feasible solutions found during the approximation process, including the best solution. Feasible solutions are defined as any solutions to the original `FunctionApproximation.Problem` object that met the constraints defined in the associated `FunctionApproximation.Options` object.

Input Arguments

solution — **Solution object from which to display all associated feasible solutions**

`FunctionApproximation.LUTSolution` object

`FunctionApproximation.LUTSolution` object from which to display all associated feasible solutions.

Examples

Display All Feasible Solutions Found During Lookup Table Approximation

Create a `FunctionApproximation.Problem` object defining a math function to approximate. Then, use the `solve` method to get a `FunctionApproximation.LUTSolution` object.

Display all feasible solutions found during the approximation process using the `displayfeasiblesolutions` method.

```
problem = FunctionApproximation.Problem('sin')
problem =
    FunctionApproximation.Problem with properties
        FunctionToApproximate: @(x)sin(x)
        NumberOfInputs: 1
        InputTypes: "numeric(0,16,13)"
        InputLowerBounds: 0
        InputUpperBounds: 6.2832
        OutputType: "numeric(1,16,14)"
        Options: [1x1 FunctionApproximation.Options]
solution = solve(problem)
```

```
solution =
```

```
FunctionApproximation.LUTSolution with properties
```

```
    ID: 8
    Feasible: "true"
```

```
displayfeasiblesolutions(solution)
```

ID	Memory (bits)	ConstraintMet	Table Size	Breakpoints	WLs	TableData	WLs
2	864	1	52		16		16
4	560	1	33		16		16
7	496	1	29		16		16
8	464	1	27		16		16
10	704	1	22		16		16

```
Best Solution
```

ID	Memory (bits)	ConstraintMet	Table Size	Breakpoints	WLs	TableData	WLs
8	464	1	27		16		16

See Also

Apps

Lookup Table Optimizer

Classes

FunctionApproximation.LUTMemoryUsageCalculator |
 FunctionApproximation.LUTSolution | FunctionApproximation.Options |
 FunctionApproximation.Problem

Functions

compare | displayallsolutions | solutionfromID | totalmemoryusage

Topics

“Optimize Lookup Tables for Memory-Efficiency Programmatically”
 “Optimize Lookup Tables for Memory-Efficiency”

Introduced in R2018a

getErrorValue

Class: FunctionApproximation.LUTSolution

Package: FunctionApproximation

Get the total error of the lookup table approximation

Syntax

```
memory = getErrorValue(solution)
```

Description

`memory = getErrorValue(solution)` returns the total error of the lookup table approximation specified by `solution`.

Input Arguments

solution — Solution to get error of

FunctionApproximation.LUTSolution object

Solution to get error of, specified as a FunctionApproximation.LUTSolution object.

Output Arguments

error — Total error of the lookup table approximation

struct

Total error of the lookup table approximation, returned as a struct.

The struct contains two fields. The `MaxErrorInSolution` field specifies the maximum difference between the original function or block and the lookup table approximation. The `ErrorUpperBound` field displays the maximum error that was acceptable according to the tolerances specified on the FunctionApproximation.Options object.

Examples

Calculate the Total Error of a Lookup Table Approximation

Create a FunctionApproximation.Problem object defining a math function to approximate. Then, use the solve method to get a FunctionApproximation.LUTSolution object.

Calculate the total error of the FunctionApproximation.LUTSolution object using the getErrorValue method.

```
problem = FunctionApproximation.Problem('sin')
```

```
problem =
```



```
FunctionApproximation.Problem with properties
  FunctionToApproximate: @(x)sin(x)
    NumberOfInputs: 1
      InputTypes: "numeric(0,16,13)"
    InputLowerBounds: 0
    InputUpperBounds: 6.2832
    OutputType: "numeric(1,16,14)"
    Options: [1x1 FunctionApproximation.Options]

solution = solve(problem)

solution =

  FunctionApproximation.LUTSolution with properties
    ID: 8
    Feasible: "true"

error = getErrorValue(solution)

error =

  struct with fields:
    MaxErrorInSolution: 0.0073
    ErrorUpperBound: 0.0078
```

See Also

FunctionApproximation.LUTSolution

Topics

“Approximate Functions with a Direct Lookup Table”

“Optimize Lookup Tables for Memory-Efficiency Programmatically”

Introduced in R2019a

replaceWithApproximate

Class: FunctionApproximation.LUTSolution

Package: FunctionApproximation

Replace block with the generated lookup table approximation

Syntax

```
replaceWithApproximate(solution)
```

Description

`replaceWithApproximate(solution)` replaces the simulink block with its lookup table approximation, generated using the `approximate` method of the `FunctionApproximation.LUTSolution` object.

Input Arguments

solution — Solution to use to replace the source block

FunctionApproximation.LUTSolution object

Solution to replace the source block, specified as a `FunctionApproximation.LUTSolution` object.

Examples

Replace a Block with an Approximation

This example shows how to approximate a block using a lookup table approximation, replace the original block with the approximation, and then revert the block back to its original state.

Open the model containing the block to approximate. In this example, replace the `tan` block with a lookup table approximation.

```
open_system('ex_luto_approx')
```



Create a `FunctionApproximation.Problem` object specifying what you want to approximate.

```
problem = FunctionApproximation.Problem('ex_luto_approx/Trigonometric Function')
```

```
problem =
```

```
  1x1 FunctionApproximation.Problem with properties:
```

```

FunctionToApproximate: 'ex_luto_approx/Trigonometric Function'
  NumberOfInputs: 1
    InputTypes: "numerictype('double')"
  InputLowerBounds: -1.5083
  InputUpperBounds: 1.5083
  OutputType: "numerictype('double')"
  Options: [1x1 FunctionApproximation.Options]

```

Use default values for all other options. To approximate the block use the `solve` method.

```
solution = solve(problem)
```

ID	Memory (bits)	Feasible	Table Size	Breakpoints WLS	TableData WL	BreakpointSpec
0	48	0	2	8	16	EvenPow
1	800	0	49	8	16	EvenPow
2	1584	1	98	8	16	EvenPow
3	640	0	39	8	16	EvenPow
4	416	0	25	8	16	EvenPow
5	1056	0	65	8	16	EvenPow
6	64	0	2	16	16	EvenPow
7	768	1	46	16	16	EvenPow
8	752	1	45	16	16	EvenPow
9	592	1	35	16	16	EvenPow
10	576	1	34	16	16	EvenPow
11	416	0	24	16	16	EvenPow
12	400	0	23	16	16	EvenPow
13	496	0	29	16	16	EvenPow
14	528	1	31	16	16	EvenPow
15	512	0	30	16	16	EvenPow
16	288	0	16	16	16	EvenPow
17	464	0	27	16	16	EvenPow
18	80	0	2	8	32	EvenPow
19	48	0	2	8	16	EvenPow
20	64	0	2	16	16	EvenPow
21	80	0	2	8	32	EvenPow
22	96	0	2	16	32	EvenPow
23	128	0	2	32	32	EvenPow
24	96	0	2	32	16	EvenPow
25	216	1	9	8	16	Expli
26	192	0	8	8	16	Expli
27	192	0	8	8	16	Expli
28	192	0	8	8	16	Expli
29	192	0	8	8	16	Expli
30	192	1	8	8	16	Expli
31	144	0	2	8	64	EvenPow
32	144	0	2	8	64	EvenPow

Best Solution

ID	Memory (bits)	Feasible	Table Size	Breakpoints WLS	TableData WL	BreakpointSpec
30	192	1	8	8	16	Expli

```
solution =
```

```
1x1 FunctionApproximation.LUTSolution with properties:
```

```
ID: 30  
Feasible: "true"
```

Generate a Simulink™ subsystem containing the lookup table approximation using the `approximate` method.

```
approximate(solution)
```

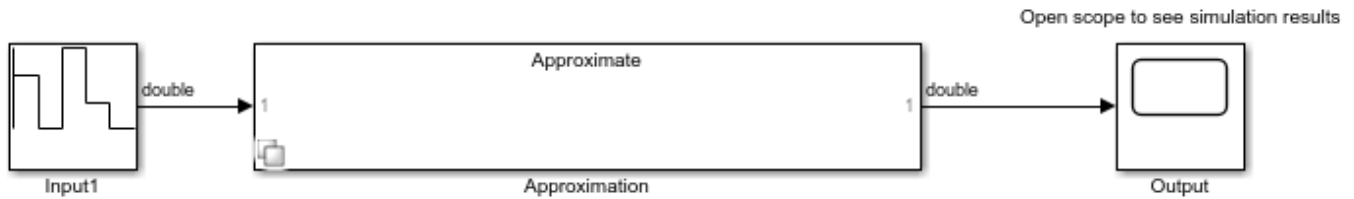

Replace the original block with the approximation.

```
replaceWithApproximate(solution)
```

You can revert the system back to its original state using the `revertToOriginal` method.

```
revertToOriginal(solution)
```

See Also

`approximate` | `revertToOriginal`

Topics

“Approximate Functions with a Direct Lookup Table”

“Optimize Lookup Tables for Memory-Efficiency Programmatically”

Introduced in R2018b

revertToOriginal

Class: FunctionApproximation.LUTSolution

Package: FunctionApproximation

Revert the block that was replaced by the approximation back to its original state

Syntax

```
revertToOriginal(solution)
```

Description

`revertToOriginal(solution)` reverts the block that was replaced by a lookup table approximation back to its original state.

Note You can only revert a block back to its original state within a single MATLAB session.

Input Arguments

solution — Solution approximating the block you want to revert to its original state

FunctionApproximation.LUTSolution object

The solution approximating the block you want to revert to its original state, specified as a FunctionApproximation.LUTSolution object.

Examples

Replace a Block with an Approximation

This example shows how to approximate a block using a lookup table approximation, replace the original block with the approximation, and then revert the block back to its original state.

Open the model containing the block to approximate. In this example, replace the tan block with a lookup table approximation.

```
open_system('ex_luto_approx')
```



Create a FunctionApproximation.Problem object specifying what you want to approximate.

```
problem = FunctionApproximation.Problem('ex_luto_approx/Trigonometric Function')
```

```
problem =
```

```
1x1 FunctionApproximation.Problem with properties:
```

```
FunctionToApproximate: 'ex_luto_approx/Trigonometric Function'
  NumberOfInputs: 1
    InputTypes: "numerictype('double')"
  InputLowerBounds: -1.5083
  InputUpperBounds: 1.5083
  OutputType: "numerictype('double')"
  Options: [1x1 FunctionApproximation.Options]
```

Use default values for all other options. To approximate the block use the solve method.

```
solution = solve(problem)
```

ID	Memory (bits)	Feasible	Table Size	Breakpoints WLS	TableData WL	BreakpointSpec:
0	48	0	2	8	16	EvenPow
1	800	0	49	8	16	EvenPow
2	1584	1	98	8	16	EvenPow
3	640	0	39	8	16	EvenPow
4	416	0	25	8	16	EvenPow
5	1056	0	65	8	16	EvenPow
6	64	0	2	16	16	EvenPow
7	768	1	46	16	16	EvenPow
8	752	1	45	16	16	EvenPow
9	592	1	35	16	16	EvenPow
10	576	1	34	16	16	EvenPow
11	416	0	24	16	16	EvenPow
12	400	0	23	16	16	EvenPow
13	496	0	29	16	16	EvenPow
14	528	1	31	16	16	EvenPow
15	512	0	30	16	16	EvenPow
16	288	0	16	16	16	EvenPow
17	464	0	27	16	16	EvenPow
18	80	0	2	8	32	EvenPow
19	48	0	2	8	16	EvenPow
20	64	0	2	16	16	EvenPow
21	80	0	2	8	32	EvenPow
22	96	0	2	16	32	EvenPow
23	128	0	2	32	32	EvenPow
24	96	0	2	32	16	EvenPow
25	216	1	9	8	16	Explicit
26	192	0	8	8	16	Explicit
27	192	0	8	8	16	Explicit
28	192	0	8	8	16	Explicit
29	192	0	8	8	16	Explicit
30	192	1	8	8	16	Explicit
31	144	0	2	8	64	EvenPow
32	144	0	2	8	64	EvenPow

```
Best Solution
```

ID	Memory (bits)	Feasible	Table Size	Breakpoints WLS	TableData WL	BreakpointSpec:
30	192	1	8	8	16	Explicit

```
solution =
```

1x1 FunctionApproximation.LUTSolution with properties:

ID: 30
Feasible: "true"

Generate a Simulink™ subsystem containing the lookup table approximation using the `approximate` method.

```
approximate(solution)
```

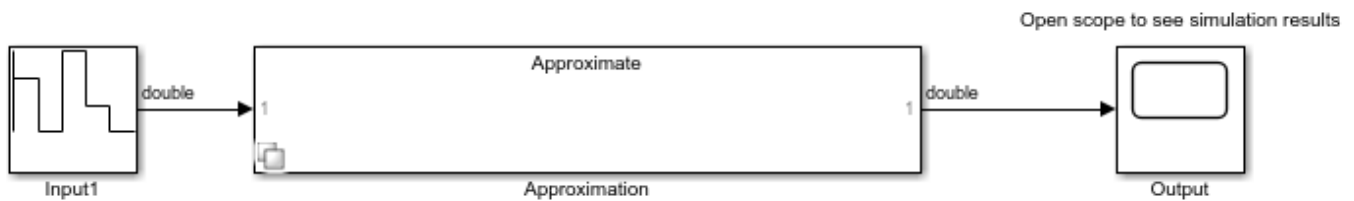

Replace the original block with the approximation.

```
replaceWithApproximate(solution)
```

You can revert the system back to its original state using the `revertToOriginal` method.

```
revertToOriginal(solution)
```

See Also

`approximate` | `replaceWithApproximate`

Topics

“Approximate Functions with a Direct Lookup Table”

“Optimize Lookup Tables for Memory-Efficiency Programmatically”

Introduced in R2018b

solutionfromID

Class: FunctionApproximation.LUTSolution

Package: FunctionApproximation

Access a solution found during the approximation process

Syntax

```
other_solution = solutionfromID(solution,id)
```

Description

`other_solution = solutionfromID(solution,id)` returns the solution associated with the FunctionApproximation.LUTSolution object, `solution`, with the ID specified by `id`.

Input Arguments

solution — Solution object

FunctionApproximation.LUTSolution object

The solution object containing the solution you want to explore, specified as a FunctionApproximation.LUTSolution object.

id — ID of the solution

scalar integer

ID of the solution that you want to explore, specified as a scalar integer.

Data Types: double

Output Arguments

other_solution — FunctionApproximation.LUTSolution specified by id

FunctionApproximation.LUTSolution object

FunctionApproximation.LUTSolution object associated with the specified ID.

Examples

Examine Infeasible Function Approximation Solution

This example shows how to use the `solutionfromID` method of the FunctionApproximation.LUTSolution object to examine other approximation solutions.

Create a FunctionApproximation.Problem object defining a math function to approximate. Then use the `solve` method to get a FunctionApproximation.LUTSolution object.

```
problem = FunctionApproximation.Problem('sin')
problem =
    1x1 FunctionApproximation.Problem with properties:
```



```

FunctionToApproximate: @(x)sin(x)
  NumberOfInputs: 1
    InputTypes: "numerictype(0,16,13)"
  InputLowerBounds: 0
  InputUpperBounds: 6.2832
  OutputType: "numerictype(1,16,14)"
  Options: [1x1 FunctionApproximation.Options]

```

```
solution = solve(problem)
```

ID	Memory (bits)	Feasible	Table Size	Breakpoints WLS	TableData WL	BreakpointSpec:
0	64	0	2	16	16	EvenPow
1	784	1	47	16	16	EvenPow
2	768	1	46	16	16	EvenPow
3	608	1	36	16	16	EvenPow
4	592	1	35	16	16	EvenPow
5	416	1	24	16	16	EvenPow
6	400	1	23	16	16	EvenPow
7	224	0	12	16	16	EvenPow
8	304	0	17	16	16	EvenPow
9	352	1	20	16	16	EvenPow
10	320	0	18	16	16	EvenPow
11	336	1	19	16	16	EvenPow
12	64	0	2	16	16	EvenPow
13	576	1	18	16	16	Explicit
14	512	0	16	16	16	Explicit
15	576	1	18	16	16	Explicit

```
Best Solution
```

ID	Memory (bits)	Feasible	Table Size	Breakpoints WLS	TableData WL	BreakpointSpec:
11	336	1	19	16	16	EvenPow

```
solution =
```

```
1x1 FunctionApproximation.LUTSolution with properties:
```

```

  ID: 11
  Feasible: "true"

```

Display all feasible solutions found during the approximation process.

```
displayfeasiblesolutions(solution)
```

ID	Memory (bits)	Feasible	Table Size	Breakpoints WLS	TableData WL	BreakpointSpec:
1	784	1	47	16	16	EvenPow
2	768	1	46	16	16	EvenPow
3	608	1	36	16	16	EvenPow
4	592	1	35	16	16	EvenPow
5	416	1	24	16	16	EvenPow
6	400	1	23	16	16	EvenPow
9	352	1	20	16	16	EvenPow
11	336	1	19	16	16	EvenPow
13	576	1	18	16	16	Explicit
15	576	1	18	16	16	Explicit

```
Best Solution
```

ID	Memory (bits)	Feasible	Table Size	Breakpoints WLS	TableData WL	BreakpointSpec
11	336	1	19	16	16	Ev

Solution with ID 5 is not listed as a feasible solution in the table. Explore this solution to see why it is not feasible.

```
solution5 = solutionfromID(solution, 5)
```

```
solution5 =
  1x1 FunctionApproximation.LUTSolution with properties:
```

```
    ID: 5
  Feasible: "true"
```

Compare the numerical behavior of the solution with ID 5.

```
compare(solution5)
```

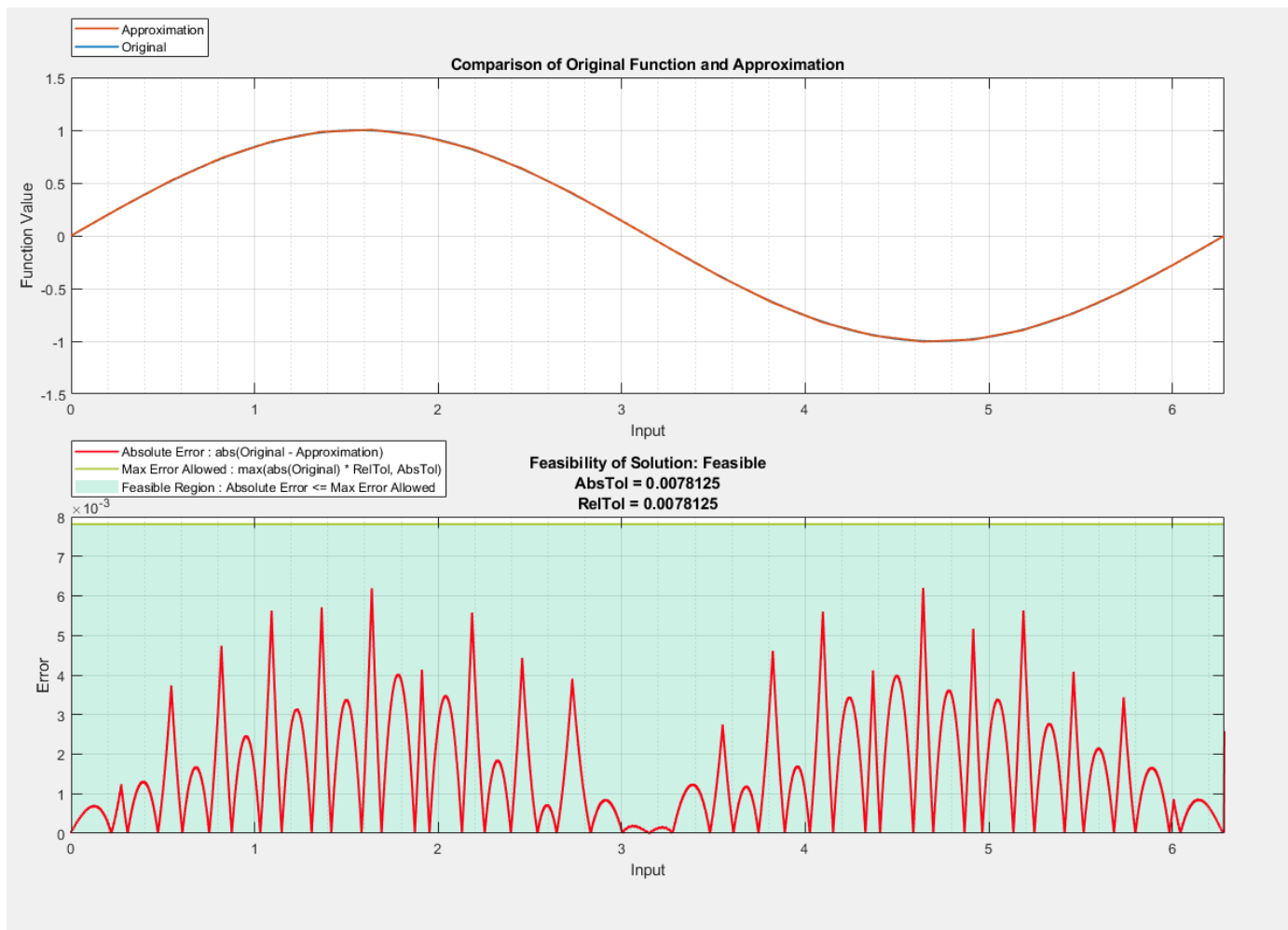

```
ans = struct with fields:
  Breakpoints: [51473x1 double]
  Original: [51473x1 double]
```

Approximate: [51473x1 double]

You can see from the plot that the solution does not meet the required tolerances.

See Also

Apps

Lookup Table Optimizer

Classes

FunctionApproximation.LUTMemoryUsageCalculator |
FunctionApproximation.LUTSolution | FunctionApproximation.Options |
FunctionApproximation.Problem

Functions

displayallsolutions | displayfeasiblesolutions | totalmemoryusage

Topics

“Optimize Lookup Tables for Memory-Efficiency Programmatically”
“Optimize Lookup Tables for Memory-Efficiency”

Introduced in R2018a

totalmemoryusage

Class: FunctionApproximation.LUTSolution

Package: FunctionApproximation

Calculate total memory used by a lookup table approximation

Syntax

```
memory = totalmemoryusage(solution,units)
```

Description

`memory = totalmemoryusage(solution,units)` returns the total memory used by the lookup table approximation specified by `solution`, in the units specified by `units`.

Input Arguments

solution — Solution to get memory of

FunctionApproximation.LUTSolution object

Solution to get memory of, specified as a FunctionApproximation.LUTSolution object.

units — Units in which to display the total memory used

'bits' (default) | 'bytes' | 'GiB' | 'KiB' | 'MiB'

Units in which to display the total memory used, specified as a character vector.

Data Types: char

Output Arguments

memory — total memory used by a lookup table approximation

scalar

Total memory used by a lookup table approximation, returned as a scalar.

Examples

Calculate the Total Memory Used by a Lookup Table Approximation

Create a FunctionApproximation.Problem object defining a math function to approximate. Then, use the solve method to get a FunctionApproximation.LUTSolution object.

Calculate the total memory used by the FunctionApproximation.LUTSolution object using the totalmemoryusage method.

```
problem = FunctionApproximation.Problem('sin')
```

```
problem =
```

```

FunctionApproximation.Problem with properties

  FunctionToApproximate: @(x)sin(x)
    NumberOfInputs: 1
      InputTypes: "numeric(0,16,13)"
    InputLowerBounds: 0
    InputUpperBounds: 6.2832
      OutputType: "numeric(1,16,14)"
      Options: [1x1 FunctionApproximation.Options]

solution = solve(problem)

solution =

  FunctionApproximation.LUTSolution with properties

      ID: 8
    Feasible: "true"

totalmemoryusage(solution, 'bytes')

ans =

    58

```

See Also

Apps

Lookup Table Optimizer

Classes

FunctionApproximation.LUTMemoryUsageCalculator |
 FunctionApproximation.LUTSolution | FunctionApproximation.Options |
 FunctionApproximation.Problem

Functions

compare | displayallsolutions | displayfeasiblesolutions | solutionfromID

Topics

“Optimize Lookup Tables for Memory-Efficiency Programmatically”
 “Optimize Lookup Tables for Memory-Efficiency”

Introduced in R2018a

solve

Class: `FunctionApproximation.Problem`

Package: `FunctionApproximation`

Solve for optimized solution to function approximation problem

Syntax

```
solution = solve(problem)
```

Description

`solution = solve(problem)` solves the optimization problem defined by the `FunctionApproximation.Problem` object, `problem`, and returns the optimized result, `solution`, as a `FunctionApproximation.LUTSolution` object.

Input Arguments

problem — Optimization problem

`FunctionApproximation.Problem`

Optimization problem specified as a `FunctionApproximation.Problem` object defining the function or Math Function block to approximate, or the Lookup Table block to optimize, and other parameters and constraints to use during the optimization process.

Output Arguments

solution — Approximation solution

`FunctionApproximation.LUTSolution` object

Approximation solution, returned as a `FunctionApproximation.LUTSolution` object.

Examples

Approximate a Math Function

Create a `FunctionApproximation.Problem` object, specifying a math function to approximate.

```
problem = FunctionApproximation.Problem('log')
```

```
problem =
```

```
FunctionApproximation.Problem with properties
```

```
FunctionToApproximate: @(x)log(x)
  NumberOfInputs: 1
      InputTypes: "numeric(1,16,10)"
InputLowerBounds: 0.6250
InputUpperBounds: 15.6250
```

```
OutputType: "numerictype(1,16,13)"
Options: [1x1 FunctionApproximation.Options]
```

Use default values for all other options.

Use the solve method to generate an approximation of the function.

```
solution = solve(problem)
```

ID	Memory (bits)	ConstraintMet	Table Size	Breakpoints	WLs	TableData	WLs
0	64	0	2	16	16	10	10
1	1984	1	122	16	16	10	10
2	1024	0	62	16	16	10	10
3	1968	1	121	16	16	10	10
4	64	0	2	16	16	10	10
5	416	1	13	16	16	10	10

Best Solution

ID	Memory (bits)	ConstraintMet	Table Size	Breakpoints	WLs	TableData	WLs
5	416	1	13	16	16	10	10

```
solution =
```

```
FunctionApproximation.LUTSolution with properties
```

```
    ID: 5
    Feasible: "true"
```

You can then use the approximate method to generate a subsystem containing the lookup table approximation.

See Also

Apps

Lookup Table Optimizer

Classes

FunctionApproximation.LUTMemoryUsageCalculator |
 FunctionApproximation.LUTSolution | FunctionApproximation.Options |
 FunctionApproximation.Problem

Functions

approximate | compare

Topics

“Optimize Lookup Tables for Memory-Efficiency Programmatically”
 “Optimize Lookup Tables for Memory-Efficiency”

Introduced in R2018a

addSpecification

Class: `fxpOptimizationOptions`

Specify known data types in a system

Syntax

```
addSpecification(options, 'BlockParameter', block_param)
```

Description

`addSpecification(options, 'BlockParameter', block_param)` specifies a known data type for a block parameter. After specifying these known parameters, if you optimize the data types in a system, the optimization process will not change the specified block parameter data type.

You can use this method in cases where parts of a system are known to always be a certain data type. For example, if the input to your system comes from an 8-bit sensor.

Input Arguments

options — Associated `fxpOptimizationOptions` object

`fxpOptimizationOptions` object

`fxpOptimizationOptions` object in which to specify a known data type for a system.

block_param — Block parameters

`Simulink.Simulation.BlockParameter` object | array of `Simulink.Simulation.BlockParameter` objects

`Simulink.Simulation.BlockParameter` objects specifying the data types of block parameters that should not change during the optimization.

Examples

Specify Known Data Types for a System Before Data Type Optimization

This example shows how to specify known data types for block parameters within your system. Load the system for which you want to optimize the data types.

```
load_system('ex_auto_gain_controller');
```

To specify that the input to the system you are converting will always be an eight-bit integer, create a `BlockParameter` object that specifies the block parameter, and the data type.

```
bp = Simulink.Simulation.BlockParameter(...  
'ex_auto_gain_controller/input_signal', 'OutDataTypeStr', 'int8');
```

The `fxpOptimizationOptions` object, `opt`, specifies options to use during data type optimization. To specify the data type of the input to the system, use the `addSpecification` method.

```
opt = fxpOptimizationOptions;
addSpecification(opt, 'BlockParameter', bp)
```

You can view all specifications added to a `fxpOptimizationOptions` object using the `showSpecifications` method.

```
showSpecifications(opt)
```

Index	Name	BlockPath	Value
1	OutDataTypeStr	ex_auto_gain_controller/input_signal	'int8'

ans=1x4 table

Index	Name	BlockPath	Value
1	OutDataTypeStr	ex_auto_gain_controller/input_signal	'int8'

See Also

Classes

OptimizationResult | OptimizationSolution | Simulink.Simulation.BlockParameter | fxpOptimizationOptions

Functions

addTolerance | explore | fxpopt | showTolerances

Topics

“Optimize Fixed-Point Data Types for a System”

“Optimize Data Types for an FPGA with DSP Slices”

Introduced in R2020a

addTolerance

Class: `fxpOptimizationOptions`

Specify numeric tolerance for optimized system

Syntax

```
addTolerance(options,block_path,port_index,tolerance_type,tolerance_value)
addTolerance(options,block_path,port_index,tolerance_type,tolerance_value,
loggingInfo)
```

Description

`addTolerance(options,block_path,port_index,tolerance_type,tolerance_value)` specifies a numeric tolerance for the output signal specified by `block_path` and `port_index`, with the tolerance type specified by `tolerance_type` and value specified by `tolerance_value`.

`addTolerance(options,block_path,port_index,tolerance_type,tolerance_value,loggingInfo)` specifies a tolerance and options for logging information with `Simulink.SimulationData.LoggingInfo`.

Input Arguments

options — Associated `fxpOptimizationOptions` object

`fxpOptimizationOptions`

`fxpOptimizationOptions` object to add a tolerance specification.

block_path — Path to block for which to add tolerance

block path name

Path to the block to add a tolerance to, specified as a character vector.

Data Types: `char` | `string`

port_index — Index of output port of block

scalar integer

Index of output port of the block specified by `block_path` for which you want to specify a tolerance, specified as a scalar integer.

Data Types: `double`

tolerance_type — Type of tolerance to specify

'AbsTol' | 'RelTol' | 'TimeTol'

Type of tolerance to add to the port indicated specified as either absolute tolerance, `AbsTol`, relative tolerance, `RelTol`, or time tolerance, `TimeTol`.

Data Types: `char`

tolerance_value — Difference between the original output and the output of the new design

scalar double

Acceptable level of tolerance for the signal specified by `block_path` and `port_index`.

If `tolerance_type` is set to `'AbsTol'`, then `tolerance_value` represents the absolute value of the maximum acceptable difference between the original output, and the output of the new design.

If `tolerance_type` is set to `'RelTol'`, then `tolerance_value` represents the maximum relative difference, specified as a percentage, between the original output, and the output of the new design. For example, a value of `1e-2` indicates a maximum difference of one percent between the original output, and the output of the new design.

If `tolerance_type` is set to `'TimeTol'`, then `tolerance_value` defines a time interval, in seconds, in which the maximum and minimum values define the upper and lower values to compare against. For more information, see “How the Simulation Data Inspector Compares Data”.

Data Types: double

LoggingInfo — Optional signal logging settings

`Simulink.SimulationData.LoggingInfo` object

Optional signal logging settings, specified as a `Simulink.SimulationData.LoggingInfo` object. Use this input argument to specify a “Decimation” value to control the amount of data logged by the Simulation Data Inspector.

```
Example: logInfo = Simulink.SimulationData.LoggingInfo(); logInfo.DecimateData = true; logInfo.Decimation = 10; addTolerance(options, 'model/blockPath', 2, 'AbsTol', 1, logInfo);
```

Examples**Specify required numeric tolerance for optimized system**

Load the system for which you want to optimize the data types.

```
load_system('ex_auto_gain_controller');
```

Create a `fxpOptimizationOptions` object with default property values.

```
options = fxpOptimizationOptions;
```

To specify a required numeric tolerance to use during the optimization process, use the `addTolerance` method of the `fxpOptimizationOptions` object. To specify several tolerance constraints, call the method once per constraint. You can specify either relative, or absolute tolerance constraints.

```
addTolerance(options, 'ex_auto_gain_controller/output_signal', 1, 'AbsTol', 5e-2);
addTolerance(options, 'ex_auto_gain_controller/input_signal', 1, 'RelTol', 1e-2);
```

Use the `showTolerances` method to display all tolerance constraints added to a specified `fxpOptimizationOptions` object.

```
showTolerances(options)
```

Path	Port_Index	Tolerance_Type	Tolerance_Value
{'ex_auto_gain_controller/output_signal'}	1	{'AbsTol'}	0.05
{'ex_auto_gain_controller/input_signal' }	1	{'RelTol'}	0.01

ans =

2x4 table

Path	Port_Index	Tolerance_Type	Tolerance_Value
{'ex_auto_gain_controller/output_signal'}	1	{'AbsTol'}	0.05
{'ex_auto_gain_controller/input_signal' }	1	{'RelTol'}	0.01

See Also

Classes

OptimizationResult | OptimizationSolution | fxpOptimizationOptions

Functions

addTolerance | explore | fxpopt | showTolerances

Topics

“Optimize Fixed-Point Data Types for a System”

Introduced in R2018a

showSpecifications

Class: `fxpOptimizationOptions`

Show specifications for a system

Syntax

```
showSpecifications(options)
```

Description

`showSpecifications(options)` displays all parameters that were specified for a system using the `addSpecification` method of the `fxpOptimizationOptions` class. If the `options` object has no parameters specified, the `showSpecifications` method does not display anything.

Input Arguments

options — Optimization options

`fxpOptimizationOptions` object

Optimization options, specified as an `fxpOptimizationOptions` object with known data types specified for a system.

Examples

Specify Known Data Types for a System Before Data Type Optimization

This example shows how to specify known data types for block parameters within your system. Load the system for which you want to optimize the data types.

```
load_system('ex_auto_gain_controller');
```

To specify that the input to the system you are converting will always be an eight-bit integer, create a `BlockParameter` object that specifies the block parameter, and the data type.

```
bp = Simulink.Simulation.BlockParameter(...
    'ex_auto_gain_controller/input_signal', 'OutDataTypeStr', 'int8');
```

The `fxpOptimizationOptions` object, `opt`, specifies options to use during data type optimization. To specify the data type of the input to the system, use the `addSpecification` method.

```
opt = fxpOptimizationOptions;
addSpecification(opt, 'BlockParameter', bp)
```

You can view all specifications added to a `fxpOptimizationOptions` object using the `showSpecifications` method.

```
showSpecifications(opt)
```

Index	Name	BlockPath	Value
-------	------	-----------	-------

```
    1      OutDataTypeStr  ex_auto_gain_controller/input_signal  'int8'
```

ans=1x4 table

Index	Name	BlockPath	Value
1	OutDataTypeStr	ex_auto_gain_controller/input_signal	'int8'

See Also

Classes

OptimizationResult | OptimizationSolution | fxpOptimizationOptions

Functions

addTolerance | explore | fxpopt | showTolerances

Topics

“Optimize Fixed-Point Data Types for a System”

Introduced in R2020a

showTolerances

Class: `fxpOptimizationOptions`

Show tolerances specified for a system

Syntax

```
showTolerances(options)
```

Description

`showTolerances(options)` displays the absolute and relative tolerances specified for a system using the `addTolerance` method of the `fxpOptimizationOptions` class. If the `options` object has no tolerances specified, the `showTolerances` method does not display anything.

Input Arguments

options — Optimization options

`fxpOptimizationOptions` object

`fxpOptimizationOptions` object specifying options and tolerances to use during the data type optimization process.

Examples

Specify required numeric tolerance for optimized system

Load the system for which you want to optimize the data types.

```
load_system('ex_auto_gain_controller');
```

Create a `fxpOptimizationOptions` object with default property values.

```
options = fxpOptimizationOptions;
```

To specify a required numeric tolerance to use during the optimization process, use the `addTolerance` method of the `fxpOptimizationOptions` object. To specify several tolerance constraints, call the method once per constraint. You can specify either relative, or absolute tolerance constraints.

```
addTolerance(options, 'ex_auto_gain_controller/output_signal', 1, 'AbsTol', 5e-2);
addTolerance(options, 'ex_auto_gain_controller/input_signal', 1, 'RelTol', 1e-2);
```

Use the `showTolerances` method to display all tolerance constraints added to a specified `fxpOptimizationOptions` object.

```
showTolerances(options)
```

Path	Port_Index	Tolerance_Type	Tolerance_Value
------	------------	----------------	-----------------

```

{'ex_auto_gain_controller/output_signal'}    1    {'AbsTol'}    0.05
{'ex_auto_gain_controller/input_signal' }    1    {'RelTol'}    0.01

```

ans =

2x4 table

Path	Port_Index	Tolerance_Type	Tolerance_Value
{'ex_auto_gain_controller/output_signal'}	1	{'AbsTol'}	0.05
{'ex_auto_gain_controller/input_signal' }	1	{'RelTol'}	0.01

See Also

Classes

OptimizationResult | OptimizationSolution | fxpOptimizationOptions

Functions

addTolerance | explore | fxpopt | showTolerances

Topics

“Optimize Fixed-Point Data Types for a System”

Introduced in R2018a

replace

Replace all Lookup Table blocks with compressed lookup tables

Syntax

```
replace(compressionResult)
replace(compressionResult, index)
```

Description

`replace(compressionResult)` replaces all n-D Lookup Table blocks in a system with the compressed versions described in the `LUTCompressionResult` object `compressionResult`.

`replace(compressionResult, index)` replaces the lookup tables at the indices specified by `index`.

Examples

Compress All Lookup Table Blocks in a System

This example shows how to compress all Lookup Table blocks in a system.

Open the model containing the lookup tables that you want to compress.

```
system = 'sldemo_fuelsys';
open_system(system)
```

Fault-Tolerant Fuel Control System

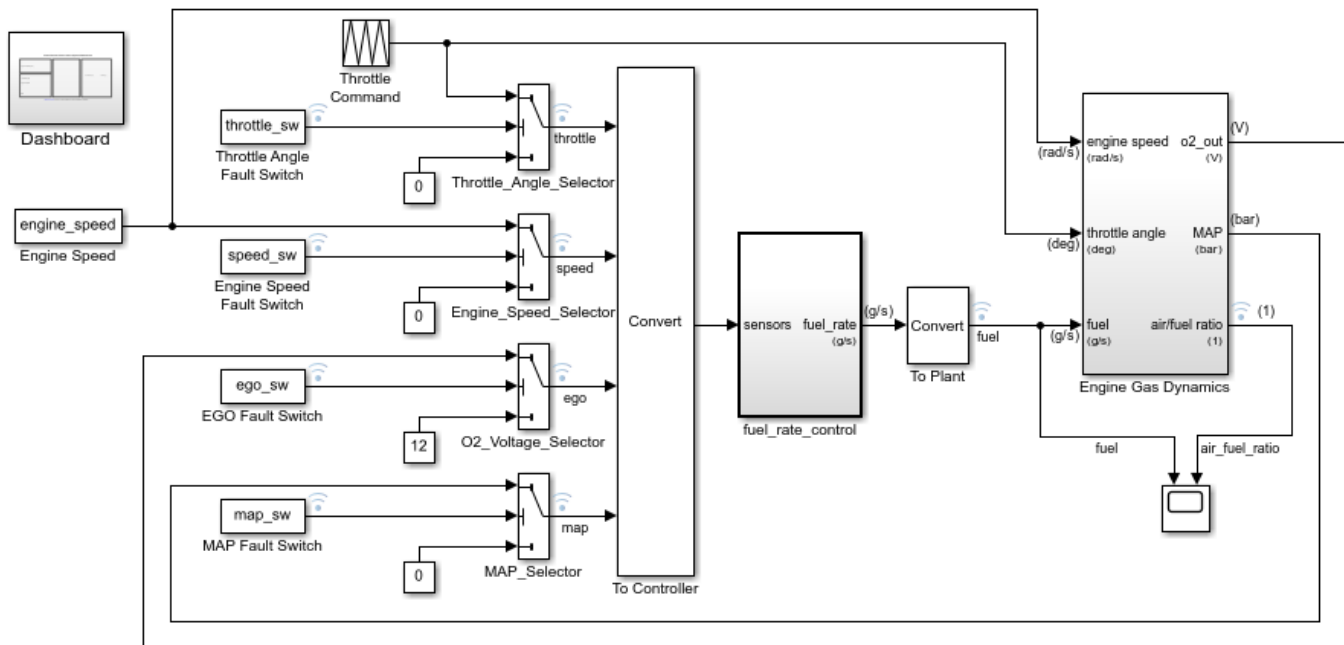

[Open the Dashboard](#) subsystem to simulate any combination of sensor failures.

Copyright 1990-2017 The MathWorks, Inc.

Use the `FunctionApproximation.compressLookupTables` function to compress all of the lookup tables in the model. The output specifies all blocks that are modified and the memory savings for each.

```
compressionResult = FunctionApproximation.compressLookupTables(system)
```

- Found 5 supported lookup tables
- Percent reduction in memory for compressed solution
 - 2.37% for `sldemo_fuelsys/fuel_rate_control/airflow_calc/Pumping Constant`
 - 2.37% for `sldemo_fuelsys/fuel_rate_control/control_logic/Throttle.throttle_estimate/Throt`
 - 3.55% for `sldemo_fuelsys/fuel_rate_control/control_logic/Speed.speed_estimate/Speed Estim`
 - 6.38% for `sldemo_fuelsys/fuel_rate_control/control_logic/Pressure.map_estimate/Pressure E`
 - 9.38% for `sldemo_fuelsys/fuel_rate_control/airflow_calc/Ramp Rate Ki`

```
compressionResult =
```

```
LUTCompressionResult with properties:
```

```

    MemoryUnits: bytes
    MemoryUsageTable: [5x5 table]
    NumLUTsFound: 5
    NumImprovements: 5
    TotalMemoryUsed: 6024
    TotalMemoryUsedNew: 5796
    TotalMemorySavings: 228
    TotalMemorySavingsPercent: 3.7849
    SUD: 'sldemo_fuelsys'
    WordLengths: [8 16 32]
    FindOptions: [1x1 Simulink.internal.FindOptions]
```

Display: 1

Use the `replace` function to replace each Lookup Table block with a block containing the original and compressed version of the lookup table.

```
replace(compressionResult);
```

You can revert the lookup tables back to their original state using the `revert` function.

```
revert(compressionResult);
```

Input Arguments

compressionResult — Results of lookup table compression

LUTCompressionResult object

Results of lookup table compression, specified as a LUTCompressionResult object.

index — Index of Lookup Table blocks to replace

scalar | vector

Index of the Lookup Table blocks to replace in the system, specified as an integer-valued scalar or vector.

The index of each lookup table corresponds to the ID column in the MemoryUsageTable property of the LUTCompressionResult object.

Data Types: double

See Also

Classes

LUTCompressionResult

Functions

FunctionApproximation.compressLookupTables | revert

Introduced in R2020a

revert

Revert compressed Lookup Table blocks to original versions

Syntax

```
revert(compressionResult)  
revert(compressionResult, index)
```

Description

`revert(compressionResult)` reverts the Lookup Table blocks compressed by the `FunctionApproximation.compressLookupTables` function back to their original state.

`revert(compressionResult, index)` reverts the lookup tables at the indices specified by `index`.

Examples

Compress All Lookup Table Blocks in a System

This example shows how to compress all Lookup Table blocks in a system.

Open the model containing the lookup tables that you want to compress.

```
system = 'sldemo_fuelsys';  
open_system(system)
```

Fault-Tolerant Fuel Control System

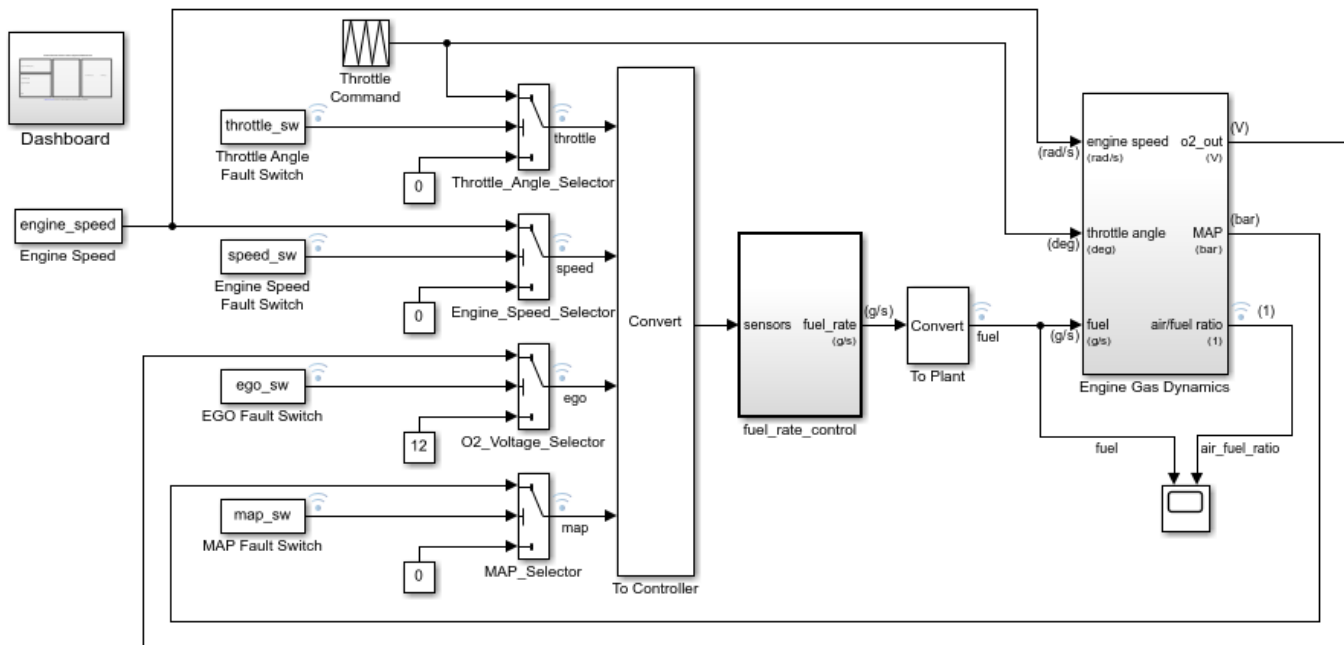

[Open the Dashboard](#) subsystem to simulate any combination of sensor failures.

Copyright 1990-2017 The MathWorks, Inc.

Use the `FunctionApproximation.compressLookupTables` function to compress all of the lookup tables in the model. The output specifies all blocks that are modified and the memory savings for each.

```
compressionResult = FunctionApproximation.compressLookupTables(system)
```

- Found 5 supported lookup tables
- Percent reduction in memory for compressed solution
 - 2.37% for `sldemo_fuelsys/fuel_rate_control/airflow_calc/Pumping Constant`
 - 2.37% for `sldemo_fuelsys/fuel_rate_control/control_logic/Throttle.throttle_estimate/Throt`
 - 3.55% for `sldemo_fuelsys/fuel_rate_control/control_logic/Speed.speed_estimate/Speed Estim`
 - 6.38% for `sldemo_fuelsys/fuel_rate_control/control_logic/Pressure.map_estimate/Pressure E`
 - 9.38% for `sldemo_fuelsys/fuel_rate_control/airflow_calc/Ramp Rate Ki`

```
compressionResult =
```

```
LUTCompressionResult with properties:
```

```

    MemoryUnits: bytes
    MemoryUsageTable: [5x5 table]
    NumLUTsFound: 5
    NumImprovements: 5
    TotalMemoryUsed: 6024
    TotalMemoryUsedNew: 5796
    TotalMemorySavings: 228
    TotalMemorySavingsPercent: 3.7849
    SUD: 'sldemo_fuelsys'
    WordLengths: [8 16 32]
    FindOptions: [1x1 Simulink.internal.FindOptions]
```

Display: 1

Use the `replace` function to replace each Lookup Table block with a block containing the original and compressed version of the lookup table.

```
replace(compressionResult);
```

You can revert the lookup tables back to their original state using the `revert` function.

```
revert(compressionResult);
```

Input Arguments

compressionResult — Results of lookup table compression

LUTCompressionResult object

Results of lookup table compression, specified as a LUTCompressionResult object.

index — Index of Lookup Table blocks to revert

scalar | vector

Index of the Lookup Table blocks to revert in the system, specified as an integer-valued scalar or vector.

The index of each lookup table corresponds to the ID column in the MemoryUsageTable property of the LUTCompressionResult object.

Data Types: double

See Also

Classes

LUTCompressionResult

Functions

FunctionApproximation.compressLookupTables | replace

Introduced in R2020a

explore

Class: OptimizationResult

Explore fixed-point implementations found during optimization process

Syntax

```
explore(result)
solution = explore(result)
solution = explore(result, n)
solution = explore(result, n, i)
```

Description

`explore(result)` opens the Simulation Data Inspector with logging data displayed for the OptimizationResult object specified by `result`.

`solution = explore(result)` opens the Simulation Data Inspector and returns an OptimizationSolution object, `solution`.

`solution = explore(result, n)` returns the n^{th} OptimizationSolution object contained in `result`.

`solution = explore(result, n, i)` returns the n^{th} OptimizationSolution object, using the i^{th} simulation scenario contained in `result`.

Input Arguments

result — OptimizationResult to explore

OptimizationResult

OptimizationResult object to explore.

If the optimization finds a feasible solution, the vector of OptimizationSolution objects contained in the `result` object is sorted by cost, with the lowest cost (most optimal) solution as the first element of the vector. If the optimization does not find a feasible solution, the vector is sorted by maximum difference from the original design.

n — Index of solution to explore

scalar integer

Index of the solution to explore, specified as a scalar integer. For example, if the optimization found a solution, `solution = explore(result, 3)` returns the solution with the 3rd lowest cost.

Data Types: double

i — Index of simulation scenario to explore

scalar integer

Index of the simulation scenario to explore, specified as a scalar integer. For example, if the optimization found a solution, `solution = explore(result, 3, 2)` returns the solution with the 3rd lowest cost, using the simulation scenario with index two.

Data Types: `double`

Output Arguments

solution — **OptimizationSolution containing information related to fixed-point implementation for system**

`OptimizationSolution`

`OptimizationSolution` object containing information related to the optimal fixed-point implementation for the system, including total cost of the implementation and the maximum difference between the baseline and the solution.

See Also

Classes

`OptimizationResult` | `OptimizationSolution` | `fxpOptimizationOptions`

Functions

`addTolerance` | `fxpopt` | `showTolerances`

Topics

“Optimize Fixed-Point Data Types for a System”

Introduced in R2018a

revert

Class: OptimizationResult

Revert system data types and settings changed during optimization to original state

Syntax

```
revert(result)
```

Description

`revert(result)` reverts the changes made during optimization, including system settings and data types, to their original state.

Input Arguments

result — OptimizationResult to revert

OptimizationResult object

OptimizationResult object to revert to its state before optimization.

Considerations

If the system you are optimizing contains a MATLAB Function block, the optimization replaces the block with a Variant Subsystem, Variant Model block in which one variant contains the original MATLAB Function block and the other variant contains the block with the optimized, fixed-point data types. When you revert a system containing a MATLAB Function block, the variant containing the original MATLAB Function block is set as the active variant.

Similarly, if the system you are optimizing contains a Stateflow® chart, the optimization process first replaces all data types in the chart with Simulink.NumericType objects. When you revert a system containing a Stateflow chart, the data type of the Simulink.NumericType objects are restored to their original data type, but the NumericType objects still exist in the model.

In both of these cases, when you revert your system, the model behaves numerically identically to how it did before the optimization, however, the model is not actually identical to its state before optimization.

See Also

Classes

OptimizationResult | OptimizationSolution | fxpOptimizationOptions

Functions

addTolerance | fxpopt | showTolerances

Topics

“Optimize Fixed-Point Data Types for a System”

Introduced in R2020a

openSimulationManager

Class: OptimizationResult

Inspect simulations run during optimization in Simulation Manager

Syntax

```
openSimulationManager(result)
```

Description

openSimulationManager(result) opens Simulation Manager with simulations displayed for the OptimizationResult object specified by result.

Input Arguments

result — OptimizationResult to inspect

OptimizationResult

OptimizationResult object containing simulations to inspect in Simulation Manager.

See Also

Classes

OptimizationResult | OptimizationSolution | fxpOptimizationOptions

Functions

addTolerance | explore | fxpopt | revert | showTolerances

Topics

Simulation Manager

“Optimize Fixed-Point Data Types for a System”

Introduced in R2020b

showContents

Class: OptimizationSolution

Get summary of changes made during data type optimization

Syntax

```
showContents(Solution)  
showContents(Solution, index)
```

Description

`showContents(Solution)` returns a summary of the changes made during optimization contained in the `OptimizationSolution` object, `Solution`, including model settings, block parameters, and data types in the model.

`showContents(Solution, index)` returns a summary of the changes made during optimization in the simulation scenario specified by `index`.

Input Arguments

Solution — Solution to data type optimization

`OptimizationSolution` object

Solution to data type optimization, specified as an `OptimizationSolution` object.

index — Index of simulation scenario

scalar integer

Index of simulation scenario, specified as a scalar integer.

Data Types: `double`

See Also

`OptimizationSolution` | `fxpopt`

Introduced in R2020a

Selected Bibliography

- [1] Burrus, C.S., J.H. McClellan, A.V. Oppenheim, T.W. Parks, R.W. Schafer, and H.W. Schuessler, *Computer-Based Exercises for Signal Processing Using MATLAB*, Prentice Hall, Englewood Cliffs, New Jersey, 1994.
- [2] Franklin, G.F., J.D. Powell, and M.L. Workman, *Digital Control of Dynamic Systems, Second Edition*, Addison-Wesley Publishing Company, Reading, Massachusetts, 1990.
- [3] *Handbook For Digital Signal Processing*, edited by S.K. Mitra and J.F. Kaiser, John Wiley & Sons, Inc., New York, 1993.
- [4] Hanselmann, H., "Implementation of Digital Controllers — A Survey," *Automatica*, Vol. 23, No. 1, pp. 7-32, 1987.
- [5] Jackson, L.B., *Digital Filters and Signal Processing, Second Edition*, Kluwer Academic Publishers, Seventh Printing, Norwell, Massachusetts, 1993.
- [6] Middleton, R. and G. Goodwin, *Digital Control and Estimation — A Unified Approach*, Prentice Hall, Englewood Cliffs, New Jersey. 1990.
- [7] Moler, C., "Floating points: IEEE Standard unifies arithmetic model," Cleve's Corner, The MathWorks, Inc., 1996. You can find this article at https://www.mathworks.com/company/newsletters/news_notes/clevescorner/index.html.
- [8] Ogata, K., *Discrete-Time Control Systems, Second Edition*, Prentice Hall, Englewood Cliffs, New Jersey, 1995.
- [9] Roberts, R.A. and C.T. Mullis, *Digital Signal Processing*, Addison-Wesley Publishing Company, Reading, Massachusetts, 1987.

